

DWR SERIES

PIVOTING WALL RACK WITH FORWARD CAPABILITIES

Pivoting, sectional wall cabinet is ideal for smaller systems in both secured and non-secured areas where space is limited and rear access to equipment is required.

FEATURES

- DWRs are now equipped with the revolutionary Forward rackrail giving you the ability to use Forward blank panels, vent panels and horizontal cable management. Rear rackrail is optional.
- DWRs now accept patented Lever Lock™ tool free and hardware free internal device and cable management system accessories in the center section and the backpan (with LL-DWR/SR-BP)
- New and improved rackrail brackets not only accommodate Lever Lock™ in the center section but all Forward Drop-In Accessories like vertical cable management and utility lighting.
- 23.5" width
- Available in 17", 22", 26" and 32" overall depths with 15", 20", 24" and 30" of useable depth
- Tool-Free Quick-Mount™ system for easy, one-person mounting of the center section to the backpan on the jobsite
- Center section rear channel accommodates optional slim power to save space, including Select Vertical PDU with RackLink™
- Optional minimum-clearance latch allows side-by-side or interior corner mounting to save room
- Reversible padlockable center section is keyed differently from optional front door for security
- Easily removable laser knockouts accommodate conduit, UHF VHF antennas, Wiremold® 4000 Series raceways, Middle Atlantic Universal Connector Panels, electrical pull-box Grounding/bonding stud in top and bottom of center section and backpan facilitates proper grounding and bonding of electronic equipment, as per NEBS and NEC standards
- Finished in a durable black textured powder coat
- UL listed in the US and Canada
- Seismic certified (when used with DWRSR-ZL latch) with an Importance factor (Ip) value of 1.5



Pivoting Wall Rack



Rackrail Brackets

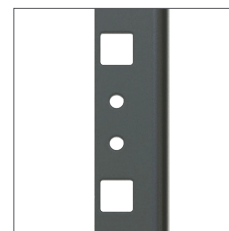

Forward Rackrail

DWR SERIES

PIVOTING WALL RACK WITH FORWARD CAPABILITIES

SPECIFICATIONS

EIA compliant 19" wall mount rack shall be Middle Atlantic Products model # DWR-___-___ (refer to chart). Overall dimensions shall be 23.4" W x ___" H x ___" D (refer to chart). Weight capacity shall be ___ lbs. Tool-Free Quick-Mount™ system enables one-person installation. Useable depth shall be ___" (refer to chart) and shall extend into the back pan 3.5". Center section and back pan shall be steel, phosphate pre-treated and finished in a black textured powder coat. Adjustable rackrail shall be constructed of 11-gauge steel with two 10-32 threaded holes per side of each marked rackspace, and a cage-nut style mount center hole that is compatible with tool-free Forward Series rackmount accessories. Rack shall be constructed to swing open for component cabling access, center section shall pivot for either left or right opening. Rack shall have a rear knockout panel with 1/2", 3/4", 1", 1-1/2", 2" and 3" electrical knockouts installed in base, and a rear knockout panel with 1/2", 3/4", 1", 1-1/2", 2" and 3" electrical knockouts, and BNC knockouts for UHF/VHF antennas installed in top. Large laser knockout on back pan shall have a 12-1/2" x 12-1/2" cutout for electrical pull-box. Fan knockouts on top and bottom shall allow for installation of up to four 4-1/2" fans. Rack shall have 2" knockouts, 4" knockouts for Wiremold 4000® Series raceways, and knockouts for UCP Series universal connector panels on the side. DWR shall accept patented Lever Lock™ tool free and hardware free internal cable and device management system accessories. DWR Series enclosures shall satisfy the 2013 CBC; 2012 IBC & ASCE 7-10 (2010 Edition) for use in areas of high seismicity, using an assumed Site Class D soil condition with lateral force requirements for protecting 155 lbs. of essential equipment in locations with the highest level of seismicity and top floor or rooftop installations with an Importance factor (Ip) of 1.5 when used with DWRSR-ZL Latch. DWR Series shall be OSHPD approved for fixed equipment anchorage in California healthcare facilities. Rack shall be UL Listed in the US and Canada to the UL-2416 (NWIN) Category when used with optional bonding kit, model # PET-K-___. Rack shall be GREENGUARD Gold Certified. Rack shall be manufactured by an ISO 9001 and ISO 14001 registered company. Rack shall be warrantied to be free from defects in materials or workmanship under normal use and conditions for the lifetime of the rack.

OPTIONS

- Front doors shall be reinforced steel, model # FD-XX (solid), VFD-XX (vented, 25% open area), LVFD-XX (vented, 64% open area), PFD-XX (plexi), (XX= # of rackspaces of DWR rack)
- Lever Lock™ tool free and hardware free internal device and cable management system accessories shall be model # LL-XXYY (XX = type, YY = size. Backpan Lever Lock™ kit] shall be LL-DWR/SR-BP
- Keyless Latch replaces keylock, fits front & rear doors, shall be models # LATCH
- Forward real rail kit, 10-32 threaded with center cage nut hole, sold in pairs, hardware included, shall be model # FWD-DWR-RRXX
- Fan kits with two 4-1/2" exhaust fans, fan guards and vent blockers shall be model # DWR-FK17 (fits DWR-xx-17), DWR-FK22 (fits DWR-xx-22), Fan kits with two 6" exhaust fans, fan guards and vent blockers shall be DWR-FK6-26 (fits DWR-xx-26), DWR-FK6-32 (fits DWR-xx-32)
- For installs in the European Union, Fan Kit with Vent Blockers shall be DWRSR-138FT-K-EU and provide 138 CFM for all depths
- Vent Blockers used to promote active thermal management, shall be model # VBK-D17 (fits DWR-XX-17), VBK-SD22 (fits DWR-XX-22), VBK-E20 (fits DWR-XX-26)
- Optional cover plate / shelf kit shall be model # DWR-CVR
- Minimum-clearance latch shall allow side-by-side or corner mounting, shall be model # DWRSR-ZL
- Optional bonding kit for UL-2416 (NWIN) compliance shall be Middle Atlantic Products PET-K-D/EWR (for backpan to center section), PET-K-D/EWRD (for backpan to center section to front door), PET-K-FD (for front door to center



PRODUCT CERTIFIED FOR
LOW CHEMICAL EMISSIONS
UL.COM/GG
UL 2818



EIA/TIA COMPLIANT

US PATENT# 7, 278, 183

SEISMIC CERTIFIED

DWR SERIES

BASIC DIMENSIONS

NOTE(S):
 1) 17", 22", 26", AND 32" DEEP MODELS ARE REPRESENTED IN THIS DRAWING (DWR-XX-17)/(DWR-XX-22)/(DWR-XX-26)/(DWR-XX-32)
 2) DIMENSIONS ARE IN THE FORMAT IN [MM]

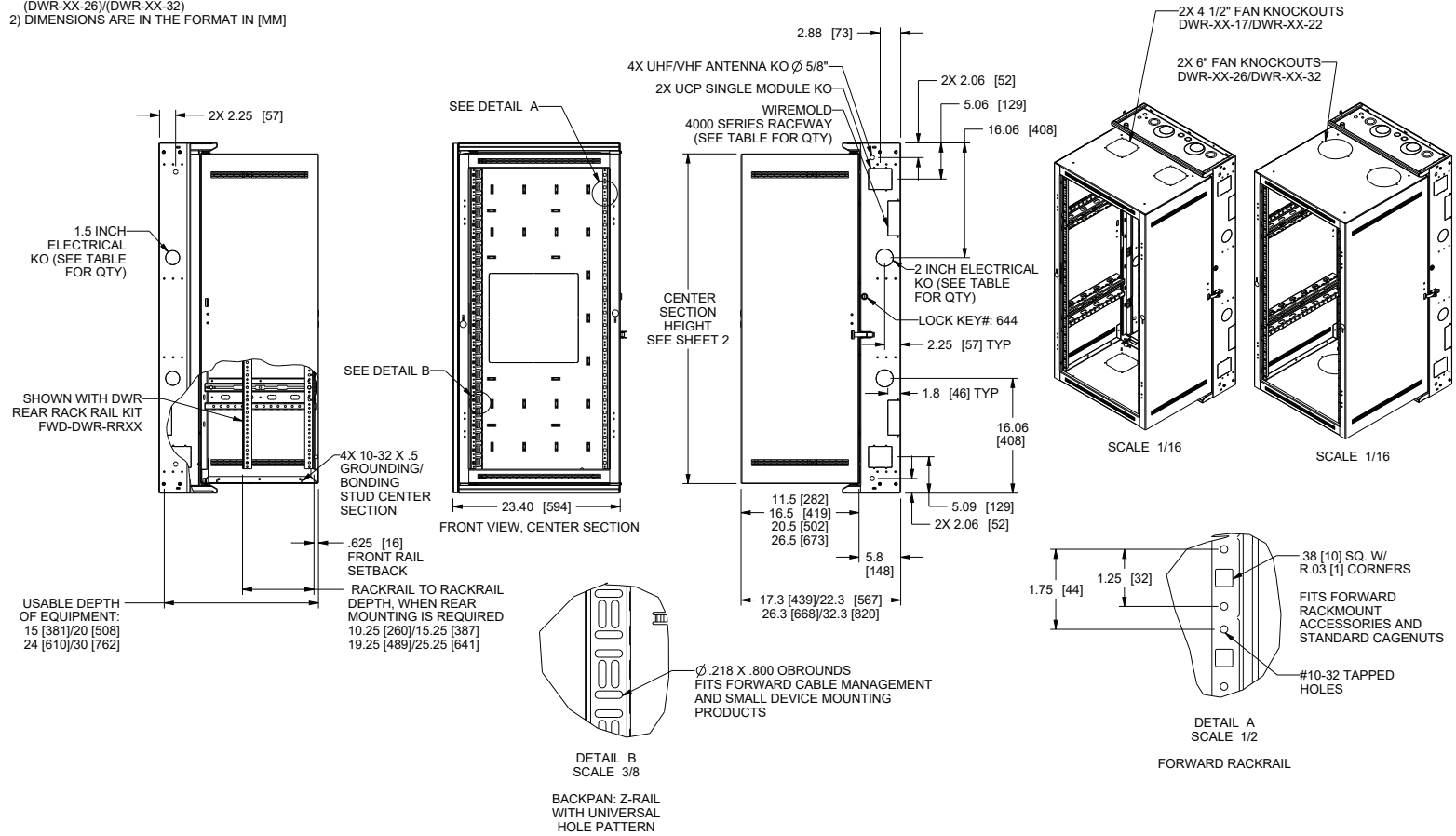

DWR SERIES

BASIC DIMENSIONS

NOTE(S):

1) 17", 22", 26" AND 32" DEEP MODELS ARE REPRESENTED IN THIS DRAWING (DWR-XX-17)/(DWR-XX-22) (DWR-XX-26)/(DWR-XX-32)

2) DIMENSIONS ARE IN THE FORMAT IN [MM]

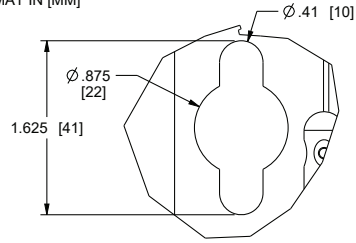

	OVERALL HEIGHT IN [MM]	CENTER SECTION HEIGHT IN [MM]	RACKING HEIGHT IN [MM]	RACK SPACES	WEIGHT CAPACITY	2" EKO BACK PAN	1.5" EKO BACK PAN	WIREMOLD 4000 SERIES	"A" WIREMOLD 4000 SERIES SPACING	"B" MOUNTING HOLE SPACING	"C" MOUNTING HOLE SPACING HINGE SIDE	"D" KNOCKOUT TOP TO MOUNTING HOLE SPACING	QUANTITY MOUNTING HOLES
DWR-10-17	24.50 [622]	21.63 [549]	17.50 [445]	10 SP	200 lbs	-	-	1	12.25 [311]	19.13[486]	19.13[486]	3.31[84]	4
DWR-10-22	24.50 [622]	21.63 [549]	17.50 [445]	10 SP	200 lbs	-	-	1	12.25 [311]	19.13[486]	19.13[486]	3.31[84]	4
DWR-12-17	28.00 [711]	25.13 [638]	21.00 [533]	12 SP	200 lbs	-	-	1	14.00 [356]	22.63[575]	22.63[575]	5.06[129]	4
DWR-12-22	28.00 [711]	25.13 [638]	21.00 [533]	12 SP	200 lbs	-	-	1	14.00 [356]	22.63[575]	22.63[575]	5.06[129]	4
DWR-12-26	28.00 [711]	25.13 [638]	21.00 [533]	12 SP	200 lbs	-	-	1	14.00 [356]	22.63[575]	22.63[575]	5.06[129]	4
DWR-12-32	28.00 [711]	25.13 [638]	21.00 [533]	12 SP	200 lbs	-	-	1	14.00 [356]	22.63[575]	22.63[575]	5.06[129]	4
DWR-16-17	35.00 [889]	32.13 [816]	28.00 [711]	16 SP	200 lbs	-	-	1	17.50 [445]	29.63[753]	29.63[753]	8.56[217]	4
DWR-16-22	35.00 [889]	32.13 [816]	28.00 [711]	16 SP	200 lbs	-	-	1	17.50 [445]	29.63[753]	29.63[753]	8.56[217]	4
DWR-18-17	38.50 [978]	35.63 [905]	31.50 [800]	18 SP	250 lbs	-	-	1	19.25 [489]	33.13[841]	33.13[841]	10.31[262]	4
DWR-18-22	38.50 [978]	35.63 [905]	31.50 [800]	18 SP	250 lbs	-	-	1	19.25 [489]	33.13[841]	33.13[841]	10.31[262]	4
DWR-18-26	38.50 [978]	35.63 [905]	31.50 [800]	18 SP	250 lbs	-	-	1	19.25 [489]	33.13[841]	33.13[841]	10.31[262]	4
DWR-18-32	38.50 [978]	35.63 [905]	31.50 [800]	18 SP	250 lbs	-	-	1	19.25 [489]	33.13[841]	33.13[841]	10.31[262]	4
DWR-21-17	43.75 [1111]	40.88 [1038]	36.75 [933]	21 SP	250 lbs	2	2	2	10.56 [268]	38.38[975]	19.19[487]	12.94[329]	5
DWR-21-22	43.75 [1111]	40.88 [1038]	36.75 [933]	21 SP	250 lbs	2	2	2	10.56 [268]	38.38[975]	19.19[487]	12.94[329]	5
DWR-24-17	49.00 [1245]	46.13 [1172]	42.00 [1067]	24 SP	300 lbs	2	2	2	10.56 [268]	43.63[1108]	21.81[554]	15.56[395]	5
DWR-24-22	49.00 [1245]	46.13 [1172]	42.00 [1067]	24 SP	300 lbs	2	2	2	10.56 [268]	43.63[1108]	21.81[554]	15.56[395]	5
DWR-24-26	49.00 [1245]	46.13 [1172]	42.00 [1067]	24 SP	300 lbs	2	2	2	10.56 [268]	43.63[1108]	21.81[554]	15.56[395]	5
DWR-24-32	49.00 [1245]	46.13 [1172]	42.00 [1067]	24 SP	300 lbs	2	2	2	10.56 [268]	43.63[1108]	21.81[554]	15.56[395]	5
DWR-35-17	68.25 [1734]	65.38 [1661]	61.25 [1558]	35 SP	300 lbs	2	2	2	10.56 [268]	62.88[1597]	21.00[533]	25.19[640]	6
DWR-35-22	68.25 [1734]	65.38 [1661]	61.25 [1558]	35 SP	300 lbs	2	2	2	10.56 [268]	62.88[1597]	21.00[533]	25.19[640]	6
DWR-35-26	68.25 [1734]	65.38 [1661]	61.25 [1558]	35 SP	300 lbs	2	2	2	10.56 [268]	62.88[1597]	21.00[533]	25.19[640]	6

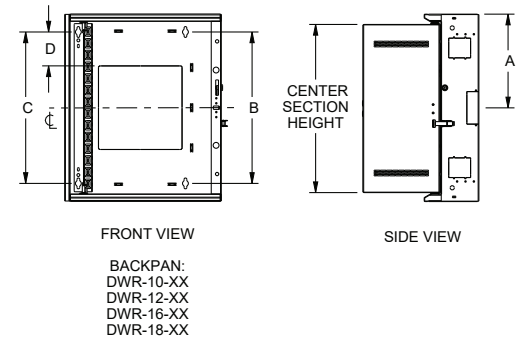
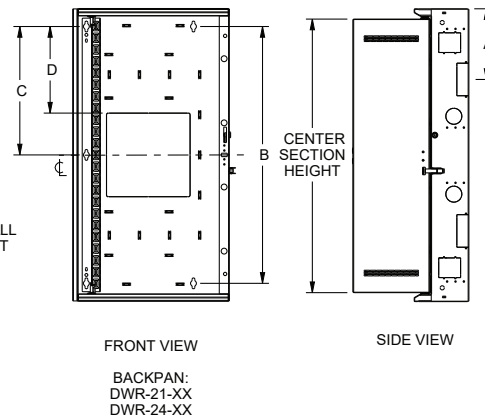
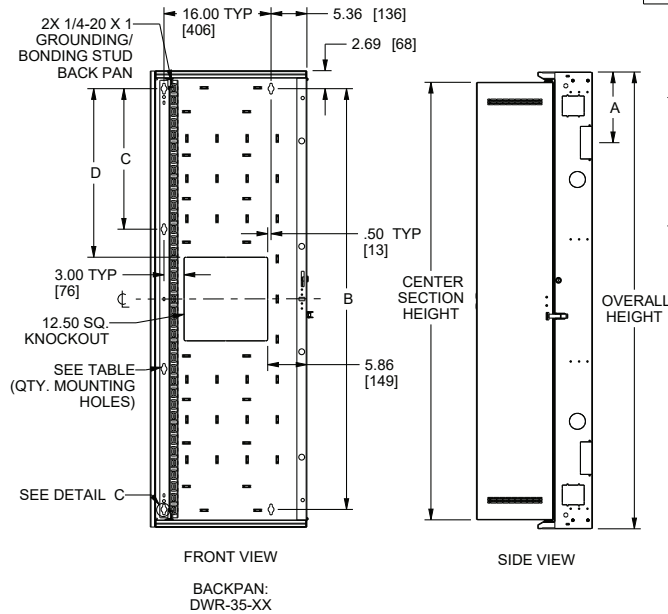

DWR SERIES

BASIC DIMENSIONS

NOTE(S):
1) DIMENSIONS ARE IN THE FORMAT IN [MM]

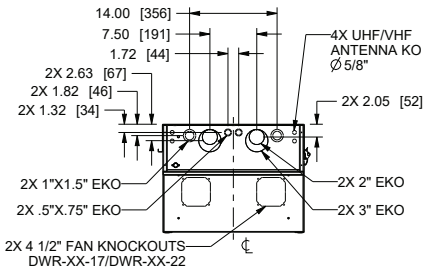

TOP VIEW

KNOCKOUTS PICTURED IN TOP VIEW ARE ALSO LOCATED ON THE BOTTOM VIEW

2X 6" FAN KNOCKOUTS DWR-XX-26/DWR-XX-32

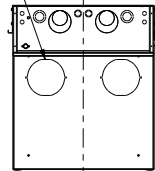

TOP VIEW

KNOCKOUTS PICTURED IN TOP VIEW ARE ALSO LOCATED ON THE BOTTOM VIEW

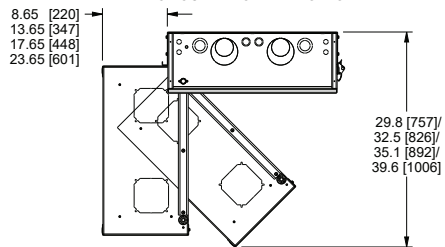

CENTER SECTION CLEARANCE

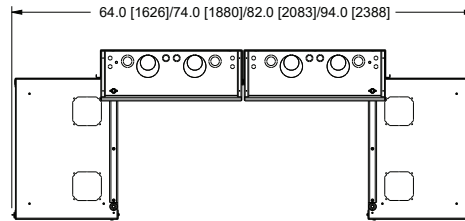

.25 [6] MIN. DISTANCE REQUIRED BETWEEN DWR'S USING ZERO CLEARANCE LATCHES MAP P/N: DWRSR-ZL

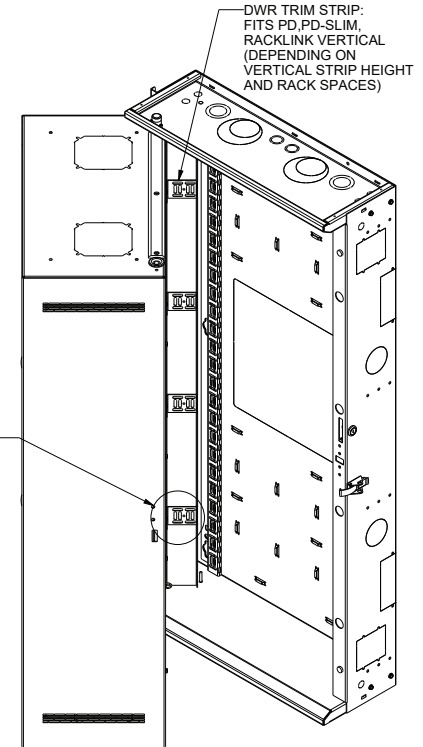
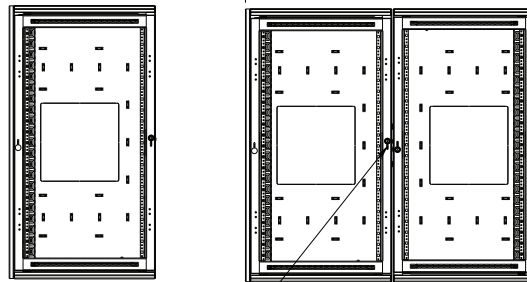
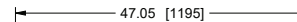
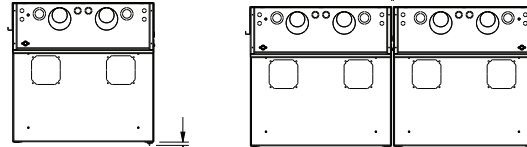

SCALE 1/8

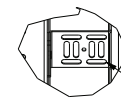

DETAIL D SCALE 1/4

Ø .218 X .800 OBROUNDS FITS FORWARD CABLE MANAGEMENT AND SMALL DEVICE MOUNTING PRODUCTS

DWR SERIES

BASIC DIMENSIONS

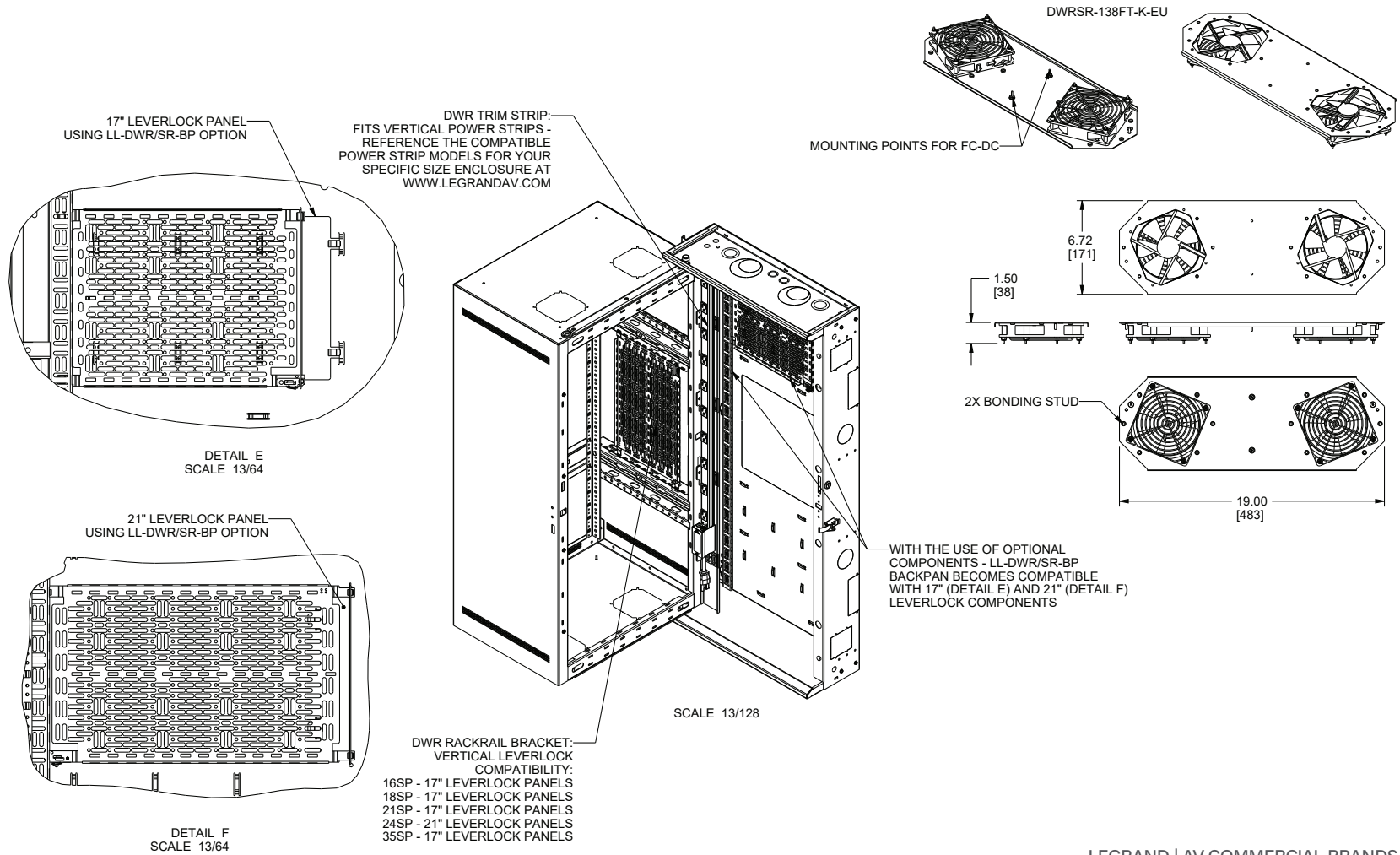

LEGRAND | AV COMMERCIAL BRANDS
 C2G | Chief | Da-Lite | Luxul | Middle Atlantic | Vaddio | Wiremold

WHAT GREAT SYSTEMS ARE BUILT ON™ | legrandav.com

USA 800.266.7225 av.middleatlantic.support@legrand.com CANADA 888.766.9770 av.middleatlantic.support@legrand.com

©2023 Legrand AV Inc. 230236 120-00025 Rev C 3/23 Middle Atlantic is a registered trademark of Legrand AV Inc. All other brand names or marks are used for identification purposes and are trademarks of their respective owners. All patents are protected under existing designations. Other patents pending.