



Simply Better Connections

PG95230 / PG95330

PG96230 / PG96330

PG98230 / PG98330

3-Phase 30-Outlet 0U eco PDU

User Manual

Compliance Statements

FEDERAL COMMUNICATIONS COMMISSION INTERFERENCE STATEMENT

This equipment has been tested and found to comply with the limits for a Class A digital device, pursuant to Part 15 of the FCC Rules. These limits are designed to provide reasonable protection against harmful interference when the equipment is operated in a commercial environment. This equipment generates, uses, and can radiate radio frequency energy and, if not installed and used in accordance with the instruction manual, may cause harmful interference to radio communications. Operation of this equipment in a residential area is likely to cause harmful interference in which case the user will be required to correct the interference at his own expense.

The device complies with Part 15 of the FCC Rules. Operation is subject to the following two conditions: (1) this device may not cause harmful interference, and (2) this device must accept any interference received, including interference that may cause undesired operation.

FCC Caution

Any changes or modifications not expressly approved by the party responsible for compliance could void the user's authority to operate this equipment.

Warning

Operation of this equipment in a residential environment could cause radio interference.

Achtung

Der Gebrauch dieses Geräts in Wohnumgebung kann Funkstörungen verursachen.



Industry Canada Statement

This Class A digital apparatus complies with Canadian ICES-003.

CAN ICES-003 (A) / NMB-003 (A)

RoHS

This product is RoHS compliant.

PE Device Safety Notice



- ◆ Set the maximum permissible breaker protection in the building circuitry to the current rating specified on the rating plate. Observe all national regulations and safety codes as well as deviations for breakers.
- ◆ Only connect the PE Device to a grounded power outlet or a grounded system!
- ◆ Make sure that the total current input of the connected systems does not exceed the current rating specified on the rating plate of the PE Device.
- ◆ There is a risk of explosion if the battery is replaced with an incorrect type. Dispose of used batteries according to the relevant instructions.

User Information

Online Registration

Be sure to register your product at our online support center:

International	http://eservice.aten.com
---------------	---

Telephone Support

For telephone support, call this number:

International	886-2-8692-6959
China	86-400--810-0-810
Japan	81-3-5615-5811
Korea	82-2-467-6789
North America	1-888-999-ATEN ext 4988 1-949-428-1111

User Notice

All information, documentation, and specifications contained in this manual are subject to change without prior notification by the manufacturer. The manufacturer makes no representations or warranties, either expressed or implied, with respect to the contents hereof and specifically disclaims any warranties as to merchantability or fitness for any particular purpose. Any of the manufacturer's software described in this manual is sold or licensed *as is*. Should the programs prove defective following their purchase, the buyer (and not the manufacturer, its distributor, or its dealer), assumes the entire cost of all necessary servicing, repair and any incidental or consequential damages resulting from any defect in the software.

The manufacturer of this system is not responsible for any radio and/or TV interference caused by unauthorized modifications to this device. It is the responsibility of the user to correct such interference.

The manufacturer is not responsible for any damage incurred in the operation of this system if the correct operational voltage setting was not selected prior to operation. PLEASE VERIFY THAT THE VOLTAGE SETTING IS CORRECT BEFORE USE.

If any bodily injury or property damage with respect to operation of the product results from users not having installed the product in accordance with the instructions provided in the product's user manual, or the product is used in an environment with a current load over the designed specifications of the product, ATEN is not liable for any loss or damage.

Product Information

For information about all ATEN products and how they can help you connect without limits, visit ATEN on the Web or contact an ATEN Authorized Reseller. Visit ATEN on the Web for a list of locations and telephone numbers:

International	http://www.aten.com
North America	http://www.aten-usa.com

Package Contents

Check to make sure that all the components are in working order. If you encounter any problem, please contact your dealer.

The eco PDU PG series standard package consists of:

- 1 3-Phase 30-Outlet 0U eco PDU unit
- 1 rack mount kit
- 1 RJ-45 to DB-9 cable
- 1 full-panel colored sticker
- 1 user instructions

Contents

Compliance Statements	6
User Information	8
Online Registration	8
Telephone Support	8
User Notice	8
Product Information	9
Package Contents	10
Contents	11
About This Manual	15
Conventions	16
Chapter 1. Introduction	
Overview	17
Features	18
Proactive Overload Protection (POP)	19
Requirements	20
Cable Holders	20
Components	21
Front View	21
Status Panel	22
Chapter 2. Hardware Setup	
Before You Begin	25
Rack Mount	25
Rack Mount Lock Positions	26
PDU Placement	27
Installation	28
Installation Diagram	29
RS-232 Command List	30
Securing the Cables	31
Chapter 3. Basic Operation and First-Time Setup	
Operation Methods	33
Browser	33
eco DC	33
SNMP	33
First-Time Setup	34
Network Configuration	35
Changing the Administrator Login	36
Moving On	37

Chapter 4. Logging In

Logging In	39
The eco PDU Main Page	40
Page Components	41

Chapter 5. Energy

Energy	43
Connections	43
PDU Status	43
Sensor Status	44
Inlet Status	44
Bank Status	45
Outlet Status	46
Configuration	47
POP Setting	47
Power On Time Schedule Settings	48
Bank Configuration	48
Bank POP Priority List	48
Outlet Configuration	49

Chapter 6. User Management

Overview	53
Administrator Information	54
SNMPv3 Account Information	54
SNMPv1/v2c Community	54
Telnet	54
SSH	54
User Information	55

Chapter 7. Log

Log	57
The System Log Event List	58
Notification Settings	59

Chapter 8. Setup

Device Management	61
Device Configuration	61
General	61
Service Ports	62
Serial Settings	63

IPv4 Configuration	63
IPv6 Configuration	65
Event Notification	66
SMTP Server	66
SNMP Trap Receivers	67
Syslog Server	68
Date/Time	68
Time Zone	69
Manual Input	69
Network Time	70
Finishing Up	70
Security	71
Working Mode	71
TLS Support	71
IPInstaller Setting	72
Session Timeout	72
Account Policy	72
IP Filter / Mac Filter	73
Authentication & Authorization	75
Private Certificate	78
Wireless Network	80
Wireless Network	80
IPv4 Configuration	81
IPv6 Configuration	82
Cascade	83
Adding a PDU	83
Deleting a PDU	84
Connecting a PDU	84
Discovering	84
Rules	85
Scheduler	86
Creating an Event	86

Chapter 9.PDU

PDU	89
Upgrade Main Firmware	89
Firmware File	90
Backup/Restore	91
<i>Station List</i>	91
Backup	91
Restore	92

Chapter 10.Telnet Commands

Remote Terminal Operations	93
--------------------------------------	----

Telnet	93
Setup	93
Logging In	94
Session Timeout	95
Commands	96
Verification	96
Read Power Outlet Status	97
Switch Outlet Status	98
Read Environmental Value	100
Close Telnet Session	101
Reboot PDU Device	102
Reset All PDU Config to Default Value	102

Appendix 105

Safety Instructions	105
General	105
Rack Mounting	107
The eco PDU's Main Power Cord	107
Securing the Power Cables	107
Resetting the Circuit Breaker	108
Recovery Procedure:	108
Technical Support	109
International	109
North America	109
IP Address Determination	110
Method 1:	110
Method 2:	111
Method 3:	111
Specifications	112
PG95230B / PG95230B2 / PG95230G	112
PG95330B / PG95330B2 / PG95330G	113
PG96230B / PG96230B2 / PG96230G	115
PG96330B / PG96330B2 / PG96330G	116
PG98230B / PG98230B2 / PG98230G	118
PG98330B / PG98330B2 / PG98330G	119
Administrator Login Failure	121
ATEN Standard Warranty Policy	122
Limited Hardware Warranty	122

About This Manual

This manual is provided to help you get the most out of your eco PDU. It covers all aspects of the power distribution unit, including installation, configuration, and operation. An overview of the information found in the manual is provided below.

Chapter 1, *Introduction*, introduces you to the unit/system. It presents purpose, features and benefits are presented, and its front and back panel components are described.

Chapter 2, *Hardware Setup*, provides step-by-step instructions for setting up your installation, and explains some basic operation procedures.

Chapter 3, *Basic Operation and First-Time Setup*, explains the procedures that the administrator employs to set up the eco PDU network environment, and change the default username and password.

Chapter 4, *Logging In*, describes how to log in to the eco PDU with an Internet browser, and explains the layout and components of the user interface.

Chapter 5, *Energy*, describes how to monitor and configure the eco PDU energy settings.

Chapter 6, *User Management*, describes how to configure the eco PDU user management such as username and password.

Chapter 7, *Log*, describes how to read and export log from the eco PDU.

Chapter 8, *Setup*, describes how to configure and manage the eco PDU as a whole.

Chapter 9, *PDU*, describes how to perform a firmware upgrade on the eco PDU, or back up and restore files.

Chapter 10, *Telnet Commands*, describes how to connect to and access the eco PDU's using Telnet.

Appendix, at the end of the manual provides technical and troubleshooting information.

Note:

- ♦ Read this manual thoroughly and follow the installation and operation procedures carefully to prevent any damage to the unit and/or connected devices.

- ◆ The product may be updated, with features and functions added, improved, or removed since the release of this manual. For an up-to-date user manual, visit <http://www.aten.com/global/en/>.
-

Conventions

This manual uses the following conventions:

- | | |
|---|--|
| Monospaced | Indicates text that you should key in. |
| [] | Indicates keys you should press. For example, [Enter] means to press the Enter key. If keys need to be chorded, they appear together in the same bracket with a plus sign between them: [Ctrl+Alt]. |
| 1. | Numbered lists represent procedures with sequential steps. |
| ◆ | Bullet lists provide information, but do not involve sequential steps. |
| > | Indicates selecting consecutive options (such as on a menu or dialog box). For example, Start > Run means to open the <i>Start</i> menu, and then select <i>Run</i> . |
|  | Indicates critical information. |

Chapter 1

Introduction

Overview

ATEN PG95 / PG96 / PG98 3-Phase 30-Outlet 0U PDU series ships with 6 x IEC 60320 C19 and 24 x IEC 60320 C13 outlets along with a 0U rack enclosure. Containing an ARM Cortex-A8 processor, the PG95 / PG96 / PG98 series delivers flexible control methods through its LAN / COM / USB / environmental sensor ports, while being able to power up all connected equipment in less than 10 seconds once plugged in. For cost-saving and space-efficient setup purposes, the PG95 / PG96 / PG98 series can be cascaded to connect up to 64 PDU units. As a result, these PDUs accommodate the increasing demand for power to high-density IT devices in server rooms and data centers.

In terms of hardware design, these PDUs have built-in energy-saving relays, a subtype of electromagnetic switch, to help operators control large amounts of current flow, which results in lower energy consumption compared to relay models incapable of energy saving.

Other highlights include the circuit breaker preinstalled onto the PG95330 / PG96330 / PG98330 models that support 30A / 32A current flow, which automatically switches off electricity supply to protect devices from overload or damage. With five colors (yellow, red, purple, blue, and green) of LCD console panel stickers available for users to choose from, differentiating between power feed settings and speeding up troubleshooting are made easier. Plus, the LCD console panel is hot-swappable and can be removed, replaced, or repaired without powering down a mission-critical connected load.

Ideal for enterprise servers, network closets, and data centers, the PG95 / PG96 / PG98 series is an intelligent power distribution and management solution that supports high-density IT applications while minimizing the overall cost.

Features

- ◆ ARM Cortex-A8 processor for flexible control methods via LAN / COM / USB / environmental sensor ports and enhanced monitoring via LCD console
- ◆ Advantageous hardware / network specifications
 - ◆ 1 Gbps Ethernet Interface
 - ◆ Auto Ping & Reboot (supported by PG96 / 98 series)
 - ◆ Remote Management Protocols: TCP/IP, UDP, HTTP, HTTPS, SSL, DHCP, SMTP, ARP, NTP, DNS, Auto Sense, Ping, SNMP V1&V2&V3, Telnet, Modbus (over TCP/IP), Wi-Fi, 802.11 a/b/g/n network protocols, IPv6, and SMS
 - ◆ Alerts / Alarms: receives alarms via SNMP, SMTP, SMS¹, and syslog
 - ◆ Scripting: JSON-RPC (Remote Procedure Call) protocol and Python scripting to control specified PDU unit (e.g. Switch On / Off)¹
 - ◆ Security: 2-level account / password login access, and IP / MAC filter, TLS 1.2, SMTP / SMTPS protocols
 - ◆ Authentication: LDAP, RADIUS, TACACS+
- ◆ **Expandable installation**
 - ◆ Allows for connecting up to 64 PDU units with cascading
 - ◆ Up to 16 PDU units can be daisy chained via LAN port connection and PON port connection to ATEN's KN series KVM over IP Switches²
 - ◆ Energy-efficient relays allow operators to control large amounts of current flow for lower energy consumption
 - ◆ Precise kWh metering (+/-1%) for better power consumption habits, baselines, and initiative tracking
 - ◆ Environmental sensor port enables RJ-45 connectivity to connect or daisy-chain up to 8 environmental sensors for monitoring and management of temperature, humidity, airflow, differential air pressure, and leaks³
 - ◆ Real-time LCD Alert sends warnings to alert users of unusual power state
 - ◆ An adjustable power cord is built in to the unit cable of 90-degree rotation to allow flexible in-rack installation, resulting in better cable organization

- ◆ Secure locking enhancement prevents power cords from becoming unplugged due to vibration or human error
- ◆ Supports ATEN's eco DC (Energy & DCIM Management Web GUI) for monitoring power distribution, energy, and environmental data from PDUs and connected devices

Note: 1. To be included in a future firmware release.

2. Firmware upgrade of the KN series is required.

3. Please contact the local sales representative for further information on the environmental sensor.

Proactive Overload Protection (POP)

The PG96 and PG98 series models feature ATEN's exclusive Proactive Overload Protection (POP) technology. Effective on all non-critical outlets, this added safety feature automatically powers off outlets when a current overload occurs.

POP mode is engaged, powering off the outlets, when the current exceeds the maximum threshold value set. The LED display shows POP and a beeper sounds. Press any button for two seconds to clear POP mode and power the outlets back on.

Note: PG95 series doesn't support POP function.

Requirements

- ◆ Browsers accessing the eco PDU must support TLS 1.0.
- ◆ For cold booting of attached computers, the computer's BIOS must support *Wake on LAN* or *System after AC Back*.
- ◆ For Safe Shutdown:
 - ◆ The computer must be running Windows (2000 or above) or Linux.
 - ◆ The *Safe Shutdown* program — PMonitor — must be installed and running on the computer (available by download from our website).

Note:

Safe shutdown program PMonitor can be downloaded from the *Support and Download* section of the product web page, as shown below

Software & Drivers ▾

OS	Description	Ver.	Release Date	File Name
<i>Other</i>				
	MIB File	v1.1.115	2015-05-05	PE_MIB_File_v1.1.115.zip
	PE MIB File	v1.1.112	2014-06-19	PE8_MIB_File_v1.1.112.tar
	PE MIB File	v1.1.109	2013-09-06	PE8_MIB_File_v1.1.109.tar
	IP Installer	v1.4.132	2012-02-10	IPInstaller-ALTUSEN_v1.4.132.zip
Linux	PMonitor	v1.1	2012-02-10	PowerMonitor_v1.1.zip
Windows	PMonitor	v1.0.081	2012-02-10	PMonitorSrv_v1.0.081.zip
	PE MIB File	v1.0.063	2012-02-10	PE8_MIB_File_v1.0.063.zip

Cable Holders

Cable holders are optional accessories. For added safety, use ATEN Lok-U-Plug cable holders to secure the cables from your attached devices in place on the eco PDU. Only the ATEN Lok-U-Plug cable holders that have been specifically designed to work with the eco PDU can be used. Using any other kinds of cable securing device could potentially result in irreversible damage or harm to the device or users. For a list of compatible cable holders, please refer to the Compatible Products section on the product web page.

Components

Front View

PG95230 / PG96230 / PG98230

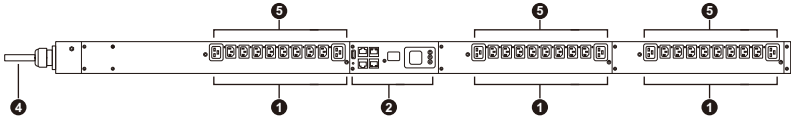

PG95330B / PG95330B2 / PG96330B / PG96330B2 / PG98330B / PG98330B2

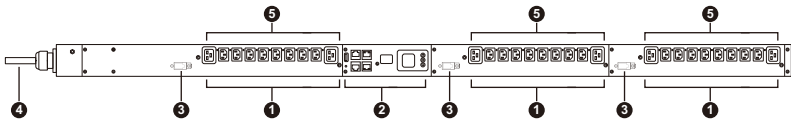

PG95330G / PG96330G / PG98330G

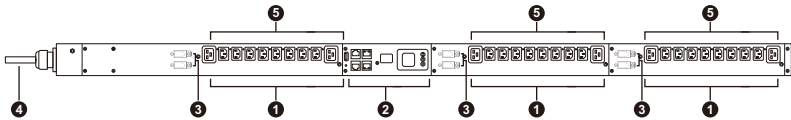

No.	Item	Description
1	power outlets*	30 in total (24 x IEC 60320 C13 + 6 x IEC 60320 C19) Bank 1-1: Outlet 1–10: 8 x C13; 2 x C19 Bank 1-2: Outlet 11–20: 8 x C13; 2 x C19 Bank 1-3: Outlet 21–30: 8 x C13; 2 x C19
2	status panel	The status panel contains: <ul style="list-style-type: none"> ◆ USB Type-A port ◆ COM + PON port ◆ Readout Section and LEDs ◆ Environmental Sensor Port ◆ LAN Ports ◆ Reset Switch Full details of this section are provided on page 22.

No.	Item	Description
3	circuit breaker (not applicable to PG95230 / PG96230 / PG98230 series)	As a safety measure, if there is an overcurrent situation in regards to the device's power, the circuit breakers will trip. Press the button to recover normal operation. Warning: See <i>Resetting the Circuit Breaker</i> , page 108 for important information about resetting a tripped circuit breaker.
4	power cord	Connects the unit to an AC power source.
5	outlet status LEDs (not applicable to PG95 series)	These LEDs indicate outlet status. Lights green for powered on. Off for powered off.

Note: Holes for ATEN Lok-U-Plug cable holders are located around the outlets. See *RS-232 Command List*, page 30, for further information.

Status Panel

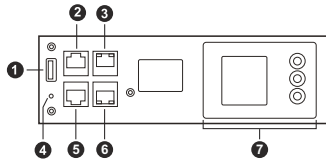

No.	Item	Description
1	USB Type-A port (firmware upgrade / log export)	Connects to a USB Type-A storage device for firmware upgrade or log export. <ul style="list-style-type: none"> ◆ USB firmware upgrade: The eco PDUs support quickly firmware upgrade through USB port. ◆ USB setting & log file restored: Users can export the setting and the log file through USB.
2	COM + PON port	<ul style="list-style-type: none"> ◆ COM: Connects to a hardware or software controller for remote control. ◆ PON: Connects to KN series for cascading up to 16 PG PDUs.
3	LAN 1 (10/100/1000M)	The cable that connects the unit to the Internet, LAN, WAN, or to cascade up to 64 PG PDUs plugs in here.

No.	Item	Description
4	reset button	<p>This button is recessed and must be pushed with a thin object, such as the end of a paper clip.</p> <ul style="list-style-type: none">◆ Press and release to reboot the device.◆ Press and hold for more than three seconds to reset the eco PDU back to its factory default settings.
5	sensor port	<p>This RJ-45 port is currently reserved for future expansion.</p>
6	LAN 2(10/100M)	<p>The cable that connects the unit to the Internet, LAN, WAN, or to cascade up to 64 PG PDUs plugs in here.</p>
7	readout section	<ul style="list-style-type: none">◆ When PDU / Phase / Bank / Outlet is selected, readouts for its current, voltage, power, and IP address appear in the display window.◆ Press the button next to the LCD display window to cycle the selection between the items; the LCDs next to the items indicate which one is currently displayed.◆ When a sensor is selected, the display displays temperature / humidity / differential pressure according to the sensor type

This Page Intentionally Left Blank

Chapter 2

Hardware Setup

Before You Begin



1. Important safety information regarding the placement of this device is provided on page 105. Please review it before proceeding.
2. Make sure that power to all the devices you will be connecting have been turned off. You must unplug the power cords of any computers that have the Keyboard Power On function.
3. See *Resetting the Circuit Breaker*, page 108 for important information about resetting a tripped circuit breaker.

Rack Mount

The eco PDU can be mounted in a 0U configuration on the side of a rack. To mount the device onto a rack, use the mounting brackets provided. The brackets can be attached either near the top and bottom of the back panel, or to the top and bottom ends of the device, as shown in the diagram below:

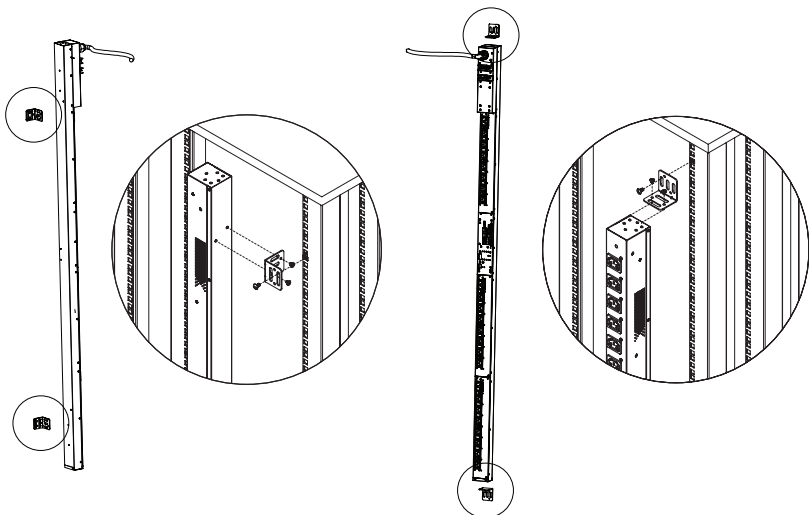

Note: The eco PDU used in the above diagram is only used for reference, it may look different from the PG series.

Rack Mount Lock Positions

When mounting onto a rack, make sure to use the correct screw positions, at the rear of the unit, that correspond to your installation scenario, as explained below:

- ◆ **T1:** Use T1 to mount the eco PDU onto an ATEN rack with its power cord extending toward the top of the rack.
- ◆ **B1:** Use B1 to mount the eco PDU onto an ATEN rack with its power cord extending toward the bottom of the rack.
- ◆ **T:** Use T to mount the eco PDU onto a 3rd-party rack with its power cord extending toward the top of the rack.
- ◆ **B:** Use B to mount the eco PDU onto a 3rd-party rack with its power cord extending toward the bottom of the rack.

Please see the diagram below for the T1, B1, T, and B Rack Mount Lock Positions.



PDU Placement

For safety reasons, the eco PDU shall NOT be installed with the power sockets facing up or down, and thus should only be installed with the power sockets facing out from a vertical position, as shown below:

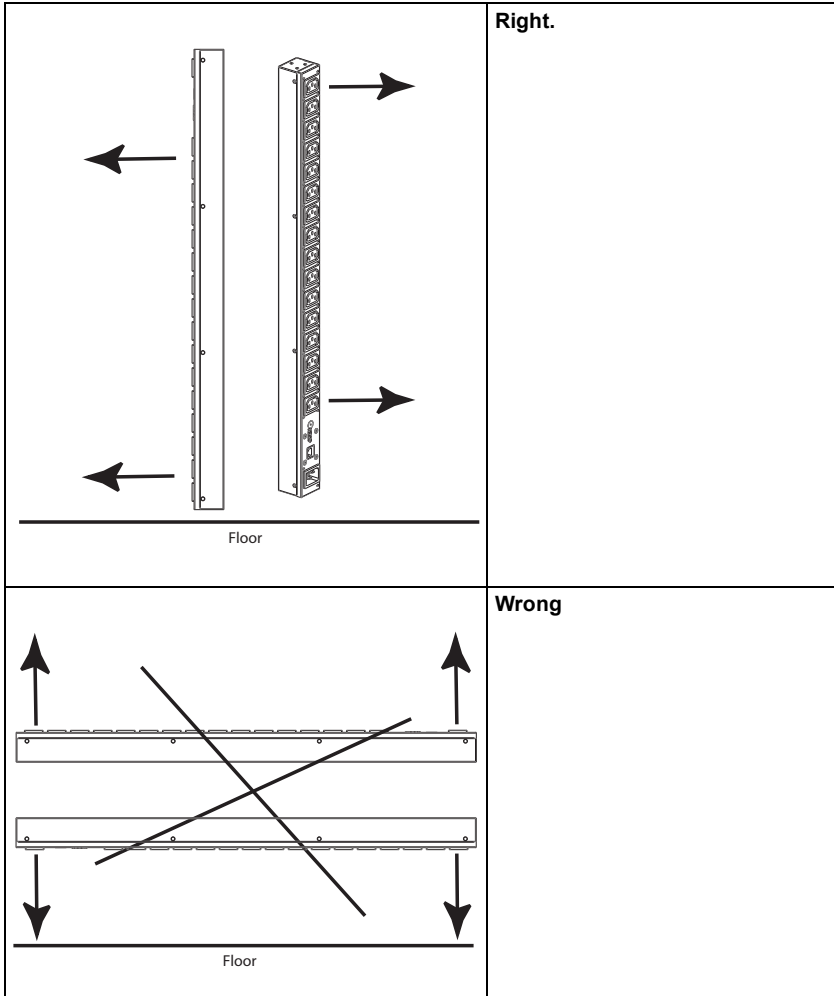

Note: The eco PDU models shown in the diagrams are for rack mount reference purposes only.

Installation

To set up your installation, refer to the installation diagram on the next page (the numbers in the diagram correspond to the numbered steps), and do the following:

1. Make sure the unit is properly grounded.

Note: Do not omit this step. Proper grounding helps prevent damage to the unit from power surges or static electricity.

2. For each device you want to connect, use its power cable to connect the device's AC power inlet to any available outlet on the eco PDU. Use ATEN Lok-U-Plug cable holders to secure them.
3. Connect the unit's LAN 1 (10/100/1000M) or LAN 2 (10/100M) port to a network using an Ethernet cable. For network redundancy, optionally connect both LAN ports to the network using 2 Ethernet cables.

Note: You can also use the LAN ports to cascade up to 64 eco PDUs.

4. (Optional) Connect an environmental sensor to the unit's sensor port.
5. (Optional) Connect an RS-232/RS-485 serial controller to the unit's COM port.

Note: You can also use the port as a PON port, connecting to an ATEN KVM over IP Switch via an Ethernet cable.

6. Connect the unit's built-in power cord to an AC power source, thereby turning it on, and then turn on the connected devices.

Once you have finished these installation steps, you can turn on the eco PDU and the connected devices.

Installation Diagram

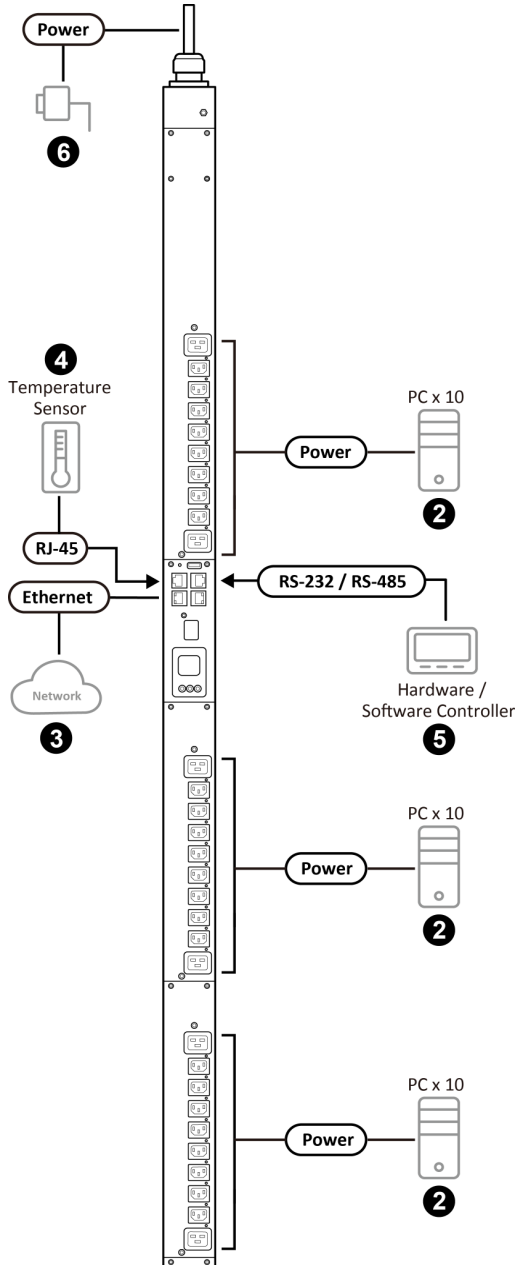

RS-232 Command List

Please refer to the table and figure below for the RS-232 management and the list of commands.

DB-9	CON	RS-232
3	RS-232 RX	3
5	GND	5
2	RS-232 TX RS-485 D+	6
1	RS-485 D-	8

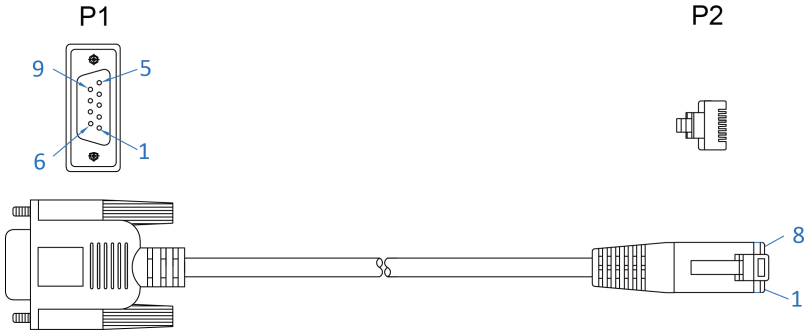

Wire Table		
P1	Color	P2
3	Black	3
5	Brown	5
2	Red	6
1	Orange	8

Securing the Cables

For added safety, use ATEN Lok-U-Plug cable holders to secure the cables of your powered devices in place on the eco PDU. Secure the cable holders using the specially designed holes around the individual power outlets, as shown below:

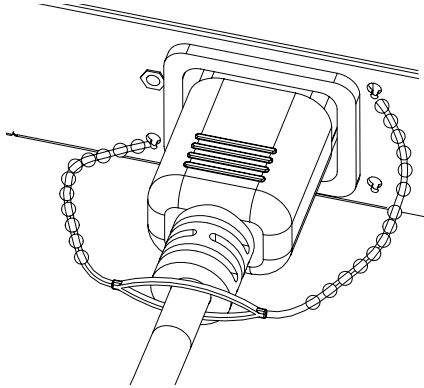

-
- Note:** 1. Cable holders are an optional accessory. See *Cable Holders*, page 20.
2. Only the ATEN Lok-U-Plug cable holders that have been specifically designed to work with the eco PDU can be used. Using any other kinds of cable securing device could potentially result in irreversible damage or harm to the device or users.
-

This Page Intentionally Left Blank

Chapter 3

Basic Operation and First-Time Setup

Operation Methods

ATEN eco PDU models provide three methods to be accessed and managed: Browser, eco DC (Energy & DCIM management web GUI), and SNMP.

Note: The following sections of this chapter contain information concerning Browser operation. For eco DC operation, please refer to the eco DC user manual. The eco DC and user manual can be downloaded from the ATEN website.

Browser

ATEN eco PDUs can be accessed and controlled via any supported Internet browser from any platform. See *First-Time Setup*, page 34, and the following sections in this chapter, for full details.

eco DC

All eco PDUs support eco DC (Energy & DCIM management web GUI). ATEN eco DC provides you with an easy method for managing multiple devices, offering an intuitive and user-friendly Graphical User Interface that allows you to configure a PDU device and monitor power status of the equipment connected to it. ATEN eco DC can be downloaded from the ATEN website, along with a separate eco DC user manual.

SNMP

ATEN eco PDUs support any 3rd-party V1, V2, V3 SNMP manager software. SNMP Management Information Database (MIB) files for the eco PDU device can be found on the software and downloaded from the ATEN website.

First-Time Setup

Once the eco PDU installation and connections have been completed, the administrator shall start configuring its network parameters, including changing the default administrator login settings and adding users.

The easiest way to accomplish this is to log in to it with a browser using a PC within the same LAN.

- Note:**
1. Since this is the first time you are logging in, use the default username and password *administrator* and *password*. For security purposes, users should change the login credentials to something unique after logging in (see *Changing the Administrator Login*, page 36).
 2. For remote methods of getting logged into the network, see *IP Address Determination*, page 110.

After you successfully log in, the eco PDU Energy/Connections page appears.

Connections | Configuration

Station List

- [001] [PG96330B2]
- [002] [PG96330B2_FOR_CA]
- [003]
- [004]
- [005]
- [006]
- [007]
- [008]
- [009]
- [010]
- [011]
- [012]
- [013]
- [014]
- [015]
- [016]
- [017]
- [018]
- [019]
- [020]
- [021]
- [022]
- [023]
- [024]

PDU Status

PDU Name	Measurement	Min Threshold	Max Threshold	PDU Status
PG96330B2_FOR_CA	Power	0.0000 W		<input type="checkbox"/> ON <input checked="" type="checkbox"/> OFF <input type="checkbox"/> Reboot
	Aggregate power dissipation	0.0000 KWH		
	Unbalanced Current	0 %		

Sensor Status

Sensor Port	Address	Temperature	Humidity	Pressure
Sensor1	1	N/A	N/A	N/A

Inlet Status

Wired Type	Lines	Measurement	Min Threshold	Max Threshold
	L1-L2	Current	0.00 A	
		Voltage	116.87 V	
		Power	0.0000 W	
		Power Dissipation	0.0000 KWH	
3-phase Delta	L2-L3	Current	0.00 A	
		Voltage	0.00 V	
		Power	0.0000 W	
		Power Dissipation	0.0000 KWH	

Note: Operation details are discussed in the next chapter. For further setup information, continue with this chapter

Network Configuration

To set up the network, do the following:

3. Click the **Setup**. The **Device Configuration** page, similar to the one below, appears.

The screenshot displays the ATEN PG96330B2 Device Configuration interface. The top navigation bar includes buttons for Energy, User, Log, Setup, and PDU. The breadcrumb trail indicates the current location: Device Configuration > Security > Wireless Network > Cascade > Rules > Scheduler. On the left, a Station List shows ports 01 through 24. The main configuration area is divided into sections: General, Service Ports, and Serial Settings. The General section includes fields for PDU Name, MAC Address, F/W Version, and Rack Location name. The Service Ports section has radio buttons for 'Only HTTPs' (selected) and 'HTTP / HTTPs', along with input fields for HTTP (80) and HTTPS (443). The Serial Settings section features a Console Mode dropdown menu set to RS232.

4. Fill in the fields according to the information provided under *Device Configuration*, page 61.

Changing the Administrator Login

To change the default administrator username and password, do the following:

1. Click **User**.

Once users have been added to the system, the Accounts page displays a detailed list of users — with more information about them in the large central panel:

Administrator information

Administrator:
 Name: Password:

SNMPv3 account information
 Name: Auth-password: Priv-Password:

SNMPv1/v2c community
 Read community: Write community:

Telnet
 Name: Password:

SSH
 Name: Password:

User information

ManagementName	Password	[C01]Outlet																														
		All	01	02	03	04	05	06	07	08	09	10	11	12	13	14	15	16	17	18	19	20	21	22	23	24	25	26	27	28	29	30
Enable ▾	1	*****	🔌	🔌	🔌	🔌	🔌	🔌	🔌	🔌	🔌	🔌	🔌	🔌	🔌	🔌	🔌	🔌	🔌	🔌	🔌	🔌	🔌	🔌	🔌	🔌	🔌	🔌	🔌	🔌	🔌	🔌
Disable ▾			🔌	🔌	🔌	🔌	🔌	🔌	🔌	🔌	🔌	🔌	🔌	🔌	🔌	🔌	🔌	🔌	🔌	🔌	🔌	🔌	🔌	🔌	🔌	🔌	🔌	🔌	🔌	🔌	🔌	🔌
Disable ▾			🔌	🔌	🔌	🔌	🔌	🔌	🔌	🔌	🔌	🔌	🔌	🔌	🔌	🔌	🔌	🔌	🔌	🔌	🔌	🔌	🔌	🔌	🔌	🔌	🔌	🔌	🔌	🔌	🔌	🔌
Disable ▾			🔌	🔌	🔌	🔌	🔌	🔌	🔌	🔌	🔌	🔌	🔌	🔌	🔌	🔌	🔌	🔌	🔌	🔌	🔌	🔌	🔌	🔌	🔌	🔌	🔌	🔌	🔌	🔌	🔌	🔌
Disable ▾			🔌	🔌	🔌	🔌	🔌	🔌	🔌	🔌	🔌	🔌	🔌	🔌	🔌	🔌	🔌	🔌	🔌	🔌	🔌	🔌	🔌	🔌	🔌	🔌	🔌	🔌	🔌	🔌	🔌	🔌
Disable ▾			🔌	🔌	🔌	🔌	🔌	🔌	🔌	🔌	🔌	🔌	🔌	🔌	🔌	🔌	🔌	🔌	🔌	🔌	🔌	🔌	🔌	🔌	🔌	🔌	🔌	🔌	🔌	🔌	🔌	🔌
Disable ▾			🔌	🔌	🔌	🔌	🔌	🔌	🔌	🔌	🔌	🔌	🔌	🔌	🔌	🔌	🔌	🔌	🔌	🔌	🔌	🔌	🔌	🔌	🔌	🔌	🔌	🔌	🔌	🔌	🔌	🔌

2. In the **Administrator Information** section at the top, reset the name and password fields to something unique, then click **Save** (at the bottom of the page.)

Note: If you forget the administrator’s name or password, short the mainboard jumper to restore the default administrator account, see *Administrator Login Failure*, page 121, in the Appendix for full details.

Moving On

After setting up the network and changing the default administrator username and password, you can proceed to other administration activities, including adding users, which is covered in the next chapter.

This Page Intentionally Left Blank

Chapter 4

Logging In

Logging In

The eco PDU can be accessed via a supported Internet browser from any platform.

Note: Browsers must support TLS 1.0.

To access the eco PDU do the following:

1. Open your browser and specify the IP address of the eco PDU you want to access in the browser's URL location bar.

Note: You can get the IP address from the eco PDU administrator, or see *IP Address Determination*, page 110, for information about setting it up yourself.

2. If a security alert dialog box appears, accept the certificate — it can be trusted. The login page appears.

The screenshot shows the ATEN NRGence™ login interface. At the top left, the ATEN logo is displayed next to the text 'NRGence™ PG9S330B2'. A blue header bar contains the title 'Please Login'. Below this, there are three input fields: 'Username' with a person icon, 'Password' with a lock icon, and 'Language' with a globe icon and 'English' selected. A prominent green 'Login' button is positioned below the fields. Underneath the button is a smaller link that says 'Reset login page'. At the very bottom of the page, a small footer reads 'ATEN International Co., Ltd. All rights reserved.'

3. Provide a valid **Username** and **Password** (set by the eco PDU administrator).
4. Select your preferred **Language** from the drop-down menu.
5. Click **Login** to bring up the browser main page.

The eco PDU Main Page

After you have successfully logged in, the eco PDU main page comes up with the Energy *Connections* page displayed:

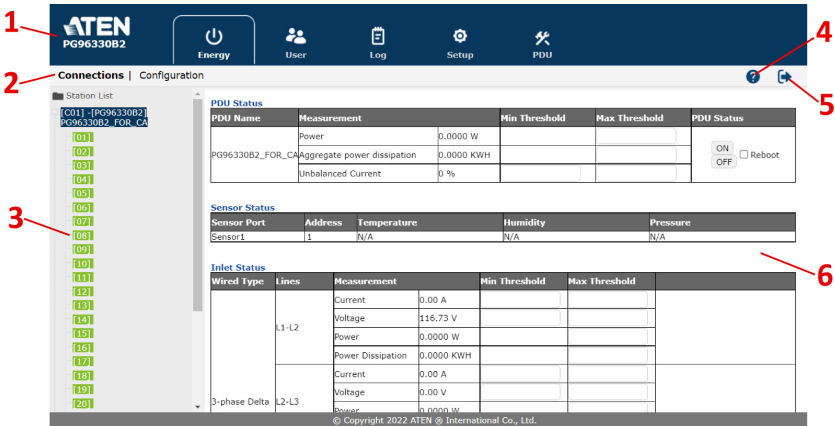

Note: The screen depicts an administrator’s page. Depending on the type of user logged in and its permissions, and your PG model, not all of these elements may appear.

Page Components

The web page screen components are described in the table below:

No.	Item	Description
1	Tab Bar	The tab bar contains the eco PDU's main operation categories. The items that appear in the tab bar are determined by the user's type, and the setting permissions that were selected when the user's account was created.
2	Menu Bar	The menu bar contains operational subcategories within the item selected on the tab bar. The items that appear in the menu bar are determined by the user's type, and the setting permissions that were selected when the user's account was created.
3	Sidebar	The sidebar provides a tree view listing of outlets that relate to the various tab bar and menu bar selections.
4	Help	Connects to the online help section on the ATEN website for the device's configuration and operation.
5	Logout	Click this button to log out of your eco PDU session.
6	Interactive Display Panel	This is your main work area. The screens that appear reflect your menu choices and the sidebar node selection.

The Energy page has two tabs: *Connections* and *Configuration*, as described in the chapters that follow.

This Page Intentionally Left Blank

Energy

Connections

When you log in to the eco PDU, the interface opens with its default selection of *Energy > Connections*, with the **PDU Status**, **Sensor Status**, **Inlet Status**, **Bank Status**, and **Outlet Status** sections displayed in the main panel.

PDU Status

PDU Name	Measurement	Min Threshold	Max Threshold	PDU Status
PG98330B2_FOR_CA	Power	0.0000 W		<input type="checkbox"/> ON <input checked="" type="checkbox"/> OFF <input type="checkbox"/> Reboot
	Aggregate power dissipation	0.0134 KWH		
	Unbalanced Current	0 %	0.0	

Sensor Status

Sensor Port	Address	Temperature	Humidity	Pressure
Sensor1	1	N/A	N/A	N/A

Inlet Status

Wired Type	Lines	Measurement	Min Threshold	Max Threshold
L1-L2		Current	0.00 A	0.0
		Voltage	114.92 V	
		Power	0.0000 W	
		Power Dissipation	0.0134 KWH	
L2-L3		Current	0.00 A	0.0
		Voltage	0.00 V	
		Power	0.0000 W	
		Power Dissipation	0.0000 KWH	

3-phase Delta

© Copyright 2022 ATEN © International Co., Ltd.

PDU Status

All eco PDU models support PDU device level monitoring. The **PDU Status** section allows you to set up a power management configuration for the PDU device as a whole:

PDU Status

PDU Name	Measurement	Min Threshold	Max Threshold	PDU Status
PG98330B2_FOR_CA	Power	0.0000 W		<input type="checkbox"/> ON <input checked="" type="checkbox"/> OFF <input type="checkbox"/> Reboot
	Aggregate power dissipation	0.0134 KWH		
	Unbalanced Current	0 %	0.0	

◆ PDU Threshold Settings

These fields are used to set the maximum threshold settings for the Power, and Aggregate Power Dissipation. If any of them falls below the minimum setting or exceeds the maximum setting, an alarm is triggered.

◆ On / Off / Reboot

You can manually turn the device on or off from this page by clicking the ON / OFF buttons. To Reboot the device, enable the *Reboot* checkbox and click **OFF** (reboot only works on the eco PDUs with PDU Outlet Status ON).

Note: PG95 series does not support On / Off / Reboot functions.

Sensor Status

All eco PDU models support sensor monitoring. The **Sensor Status** section allows you to set up a sensor management configuration for the PDU device:

Sensor Status

Sensor Port	Address	Temperature	Humidity	Pressure
Sensor1	1	N/A	N/A	N/A
	Max Threshold	40.0		
	Min Threshold	30.0		

◆ Sensor 1

If you have sensors installed in your installation, use these fields to set the maximum and minimum threshold settings for Temperature, Humidity, and/or Pressure.

Note: Sensors are optional accessories. Check with your dealer for details.

Inlet Status

All eco PDU models support Inlet level monitoring. The **Inlet Status** section allows you to set up a power management configuration for each of the individual inlets:

Inlet Status

Wired Type	Lines	Measurement	Min Threshold	Max Threshold
3-phase Delta	L1-L2	Current	0.00 A	0.0
		Voltage	115.02 V	
		Power	0.0000 W	
		Power Dissipation	0.0134 KWH	
	L2-L3	Current	0.00 A	0.0
		Voltage	0.00 V	
		Power	0.0000 W	
		Power Dissipation	0.0000 KWH	
	L3-L1	Current	0.00 A	0.0
		Voltage	114.93 V	
		Power	0.0000 W	
		Power Dissipation	0.0000 KWH	

◆ Threshold Settings

These fields are used to set the maximum and minimum threshold settings for the Aggregate Current, Voltage, Power, and Aggregate Power Dissipation. If any of them falls below the minimum setting or exceeds the maximum setting, an alarm is triggered.

Bank Status

All eco PDU models support Bank level monitoring. The **Bank Status** section allows you to set up a power management configuration for each of the individual banks (3 banks for PG95230 / PG96230 / PG98230 series, PG95330B / PG96330B / PG98330B, and PG95330B2 / PG96330B2 / PG98330B2; 6 banks for PG95330G / PG96330G / PG98330G):

Bank Status							
Bank	Bank Name	Lines	Measurement	Min Threshold	Max Threshold	Bank Status	
[01]		L1-L2	Current	0.00 A		0.0	<input type="checkbox"/> ON <input type="checkbox"/> OFF <input type="checkbox"/> Reboot
			Voltage	115.27 V			
			Power	0.0000 W			
			Power Dissipation	0.0134 KWH			
			Voltage frequency	59.95 Hz			
			Breaker	ON			
[02]		L2-L3	Current	0.00 A		0.0	<input type="checkbox"/> ON <input type="checkbox"/> OFF <input type="checkbox"/> Reboot
			Voltage	0.00 V			
			Power	0.0000 W			
			Power Dissipation	0.0000 KWH			
			Voltage frequency	0.00 Hz			
			Breaker	OFF			
[03]		L3-L1	Current	0.00 A		0.0	<input type="checkbox"/> ON <input type="checkbox"/> OFF <input type="checkbox"/> Reboot
			Voltage	115.19 V			
			Power	0.0000 W			
			Power Dissipation	0.0000 KWH			
			Voltage frequency	60.12 Hz			
			Breaker	ON			

◆ Threshold Settings

These fields are used to set the maximum and minimum threshold settings for the Aggregate Current, Voltage, Power, and Power Dissipation. If any of them falls below the minimum setting or exceeds the maximum setting, an alarm is triggered.

- ◆ **Voltage Frequency** is displayed here in Hz.
- ◆ **Breaker** status (ON / OFF) displays here. The Breaker status is only available on PG95330 / PG96330 / PG98330 series.

◆ On / Off / Reboot

You can manually turn the device on or off from this page by clicking the ON / OFF buttons. To Reboot the device, enable the *Reboot* checkbox and click **OFF** (reboot only works on the eco PDUs with Bank Outlet Status ON).

Note: PG95 series does not support On / Off / Reboot functions.

Outlet Status

Only PG98 series supports Outlet level monitoring. The **Outlet Status** section allows you to set up a power management configuration for each of the individual outlets:

Outlet Status									
Outlet	Outlet Name	Lines	Auto Ping Status	Measurement		Min Threshold	Max Threshold	Outlet Status	Outlet Switching
[01]		L1-L2	N/A	Current	0.00 A		0.0	ON	ON OFF <input type="checkbox"/> Reboot
				Voltage	112.41 V				
				Power	0.0000 W				
				Power Dissipation	0.0066 KWH				
				Power factor	1.00				
[02]		L1-L2	N/A	Current	0.00 A		0.0	ON	ON OFF <input type="checkbox"/> Reboot
				Voltage	112.41 V				
				Power	0.0000 W				
				Power Dissipation	0.0000 KWH				
				Power factor	1.00				
[03]		L1-L2	N/A	Current	0.00 A		0.0	ON	ON OFF <input type="checkbox"/> Reboot
				Voltage	112.41 V				
				Power	0.0000 W				
				Power Dissipation	0.0000 KWH				
				Power factor	1.00				

◆ Threshold Settings

These fields are used to set the maximum and minimum threshold settings for the Aggregate Current, Voltage, Power, and Power Dissipation. If any of them falls below the minimum setting or exceeds the maximum setting, an alarm is triggered.

◆ Outlet Status

Indicates each outlet status (ON / OFF / POP).

◆ On / Off / Reboot

You can manually turn the outlet on or off from this page by clicking the ON / OFF buttons. To Reboot the device, enable the *Reboot* checkbox and click **OFF** (reboot only works on the eco PUDs with Outlet Status ON).

Configuration

The *Configuration* page is used to configure the settings of the eco PDU at the bank and individual power outlet level:

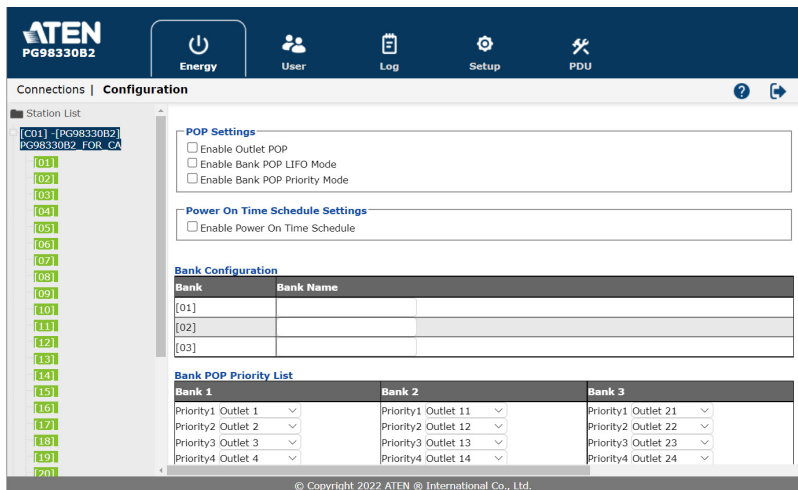

POP Setting

This section allows you to configure the settings for ATEN's exclusive Proactive Overload Protection (POP) technology. Effective on all non-critical outlets, this added safety feature automatically powers off when a current overload occurs. Check the checkbox and click Save to enable the selected POP mode(s).

POP Settings

- Enable Outlet POP
- Enable Bank POP LIFO Mode
- Enable Bank POP Priority Mode

- ◆ **Enable Outlet POP Mode:** Automatically powers off the outlets when a current overload occurs.
- ◆ **Enable Bank POP LIFO Mode:** Automatically powers off the outlets in a last-in first-out sequence when a current overload occurs.
- ◆ **Enable Bank POP Priority Mode:** Automatically powers off the outlets according to a pre-configured Bank POP Priority List. See *Bank POP Priority List*, page 48.

Note: PG95 series does not support POP function.

Power On Time Schedule Settings

Check the Enable Power On Time Schedule box to use the Power ON Delay setting to set the amount of time the eco PDU waits before powering on an outlet. See Power ON Delay in the table on the next page.

Power On Time Schedule Settings

Enable Power On Time Schedule

Note: PG95 series does not support Enable Power On Time Schedule.

Bank Configuration

Each bank can be given a distinctive name (3 banks for PG98230 series, PG98330B, and PG98330B2; 6 banks for PG98330G). The maximum number of characters is 15.

Bank Configuration

Bank	Bank Name
[01]	Abcdefghij
[02]	12345612
[03]	22

Bank POP Priority List

This field allows you to set up a POP priority list that the eco PDU powers off the outlets according to sequence configured in this list.

Bank POP Priority List

Bank 1	Bank 2	Bank 3
Priority1 Outlet 1 <input type="button" value="v"/>	Priority1 Outlet 11 <input type="button" value="v"/>	Priority1 Outlet 21 <input type="button" value="v"/>
Priority2 Outlet 2 <input type="button" value="v"/>	Priority2 Outlet 12 <input type="button" value="v"/>	Priority2 Outlet 22 <input type="button" value="v"/>
Priority3 Outlet 3 <input type="button" value="v"/>	Priority3 Outlet 13 <input type="button" value="v"/>	Priority3 Outlet 23 <input type="button" value="v"/>
Priority4 Outlet 4 <input type="button" value="v"/>	Priority4 Outlet 14 <input type="button" value="v"/>	Priority4 Outlet 24 <input type="button" value="v"/>
Priority5 Outlet 5 <input type="button" value="v"/>	Priority5 Outlet 15 <input type="button" value="v"/>	Priority5 Outlet 25 <input type="button" value="v"/>
Priority6 Outlet 6 <input type="button" value="v"/>	Priority6 Outlet 16 <input type="button" value="v"/>	Priority6 Outlet 26 <input type="button" value="v"/>
Priority7 Outlet 7 <input type="button" value="v"/>	Priority7 Outlet 17 <input type="button" value="v"/>	Priority7 Outlet 27 <input type="button" value="v"/>
Priority8 Outlet 8 <input type="button" value="v"/>	Priority8 Outlet 18 <input type="button" value="v"/>	Priority8 Outlet 28 <input type="button" value="v"/>
Priority9 Outlet 9 <input type="button" value="v"/>	Priority9 Outlet 19 <input type="button" value="v"/>	Priority9 Outlet 29 <input type="button" value="v"/>
Priority10 Outlet 10 <input type="button" value="v"/>	Priority10 Outlet 20 <input type="button" value="v"/>	Priority10 Outlet 30 <input type="button" value="v"/>

Outlet Configuration

This page lets you set up the power management configuration for the selected outlet. The meanings of the field headings are described in the following table.

Outlet Configuration						
Outlet	Outlet Name	Confirmation Required	Delay Time (sec)		Remote Turn ON Method	Autoping Monitoring
			Power ON	Power OFF		
[01]	<input type="text"/>	<input type="checkbox"/>	5	1	Method: Kill the Power MAC Address: 000000000000	<input type="radio"/> Enable <input checked="" type="radio"/> Disable Outlet control: <input type="radio"/> Enable <input checked="" type="radio"/> Disable Ping interval: 60 sec(s) Wait time before first ping: 10 sec(s) Consecutive failed pings (Reboot outlet): 1 time(s) Max outlet reboot times: 1 time(s) IP Address: 0.0.0.0
[02]	<input type="text"/>	<input type="checkbox"/>	5	1	Method: Kill the Power MAC Address: 000000000000	<input type="radio"/> Enable <input checked="" type="radio"/> Disable Outlet control: <input type="radio"/> Enable <input checked="" type="radio"/> Disable Ping interval: 60 sec(s) Wait time before first ping: 10 sec(s) Consecutive failed pings (Reboot outlet): 1 time(s) Max outlet reboot times: 1 time(s) IP Address: 0.0.0.0
[03]	<input type="text"/>	<input type="checkbox"/>	5	1	Method: Kill the Power MAC Address: 000000000000	<input type="radio"/> Enable <input checked="" type="radio"/> Disable Outlet control: <input type="radio"/> Enable <input checked="" type="radio"/> Disable Ping interval: 60 sec(s) Wait time before first ping: 10 sec(s) Consecutive failed pings (Reboot outlet): 1 time(s) Max outlet reboot times: 1 time(s) IP Address: 0.0.0.0

Control/Display	Description
Outlet	Shows the port number of the listed outlet.
Outlet Name	Each outlet can be given a distinctive name. The maximum number of characters is 48.
Confirmation Required	If this option is enabled (there is a check in the checkbox), a dialog box comes up asking you to confirm a power operation before it is performed. If it is disabled (there is no check in the checkbox), the operation is performed without confirmation.
Delay Time (sec) Power ON	Sets the amount of time the eco PDU waits after the Power Button is clicked (see <i>Outlet Status</i> , page 46), before it turns on the power to the outlet. Note: The default delay time is 5 seconds; the maximum is 999 seconds.
Delay Time (sec) Power OFF	Sets the amount of time the eco PDU waits after the Power Button is clicked (see <i>Outlet Status</i> , page 46), before it turns off the power to the outlet. The default delay time is 1 seconds. The maximum delay time is 999 seconds.

Control/Display	Description
Remote Turn ON Method	<p>Use the drop-down menu to select one of the choices, below:</p> <ul style="list-style-type: none"> ◆ Wake on LAN <p>This is a safe shutdown and restart option. If this is selected, when an outlet is turned Off, the eco PDU first sends a message to the computer telling it to prepare for a shutdown; it then waits for the amount time set in the <i>Power Off Delay</i> field to give the OS time to close down before the computer is powered down to standby mode.</p> <p>Likewise, when the outlet is turned On, the eco PDU waits for the amount time set in the <i>Power On Delay</i> field, then sends an Ethernet message to the computer connected to the outlet telling the computer to turn itself On.</p> <p>Note: For safe shutdown and restart, the computer must be running Windows (98 or higher), or Linux, and the <i>Safe Shutdown</i> program (available by download from our website), must be installed and running on the computer.</p> ◆ System after AC Back <p>This is a safe shutdown and restart option. If this is selected, when an outlet is turned Off, the eco PDU first sends a message to the computer telling it to prepare for a shutdown; it then waits for the amount time set in the <i>Power Off Delay</i> field to give the OS time to close down before the computer is powered down.</p> <p>When the outlet is turned On, the eco PDU waits for the amount time set in the <i>Power On Delay</i> field, then sends power to the server. When the server receives the power, it turns itself on.</p> <p>Note: For safe shutdown and reboot, the computer must be running Windows (98 or higher), or Linux, and the <i>Safe Shutdown</i> program (available by download from our website), must be installed and running on the computer.</p> ◆ Kill the Power <p>If this option is selected, the eco PDU waits for the amount time set in the <i>Power Off Delay</i> field, and then turns the outlet's power Off. Turning the power off performs a cold (non-safe) shutdown.</p>
MAC Address	<p>In order to use either of the safe shutdown and restart methods, the MAC address of the computer connected to the outlet must be filled in here.</p>

Control/Display	Description
Auto Ping Method	<p><i>Auto Ping Method</i> defines the mechanism which the eco PDU uses to ping a device and to reboot the outlet. To enable this setting, check the Enable checkbox, or check the Disable checkbox to disable.</p> <ul style="list-style-type: none"> ◆ Outlet Control Enable this setting to reboot the outlet when the eco PDU fails to ping the device for the specified number of times, as set in the Cont. Failed Pings (Reboot Outlet) field. ◆ Ping Interval Enter the number of seconds to elapse between each auto-ping that is sent to test the network device. ◆ Wait Time Before First Ping Enter the duration to wait before the outlet is powered on during a reboot. ◆ Cont. Failed Pings (Reboot Outlet) Enter the maximum number of times that the eco PDU pings the specified device after an initial failure. ◆ Max Outlet Reboot Times Enter the maximum number of times that the eco PDU reboots the specified device after the consecutive pings, as specified in the Cont. Fail Reset field. ◆ IP Address Enter the IP address of the device you want to ping.

When you have finished making your configuration settings, click **Save**.

This Page Intentionally Left Blank

Chapter 6

User Management

Overview

Selecting the *User* tab brings up the *Accounts* menu, with the *Administrator Information* and *User Information* displayed in the main panel.

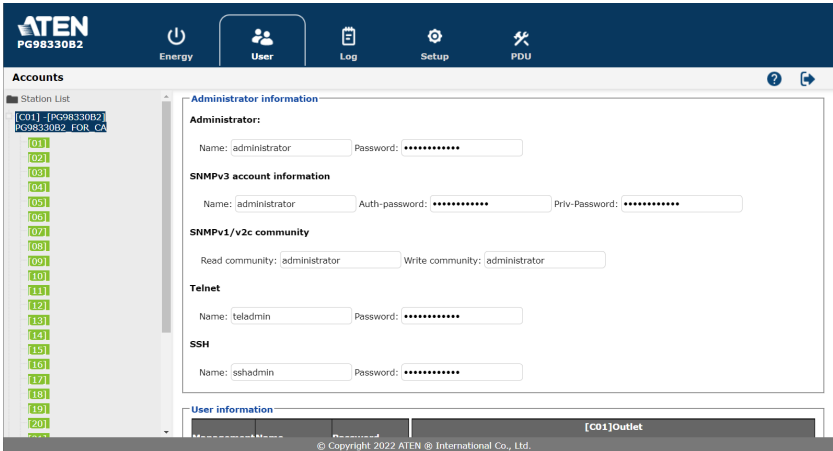

Note: There is a pre-installed administrator account. It can be used to set up the device and to begin creating users and groups. The username and password for this account is *administrator* and *password*. For security purposes, we strongly recommend changing these to something unique.

Administrator Information

This section is used to set the administrator username and password. Only administrators can view this section. For details, see *Changing the Administrator Login*, page 36.

Administrator information

Administrator:

Name: Password:

SNMPv3 account information

Name: Auth-password: Priv-Password:

SNMPv1/v2c community

Read community: Write community:

Telnet

Name: Password:

SSH

Name: Password:

SNMPv3 Account Information

Enter values for Name, Auth-Password and Priv-Password for SNMPv3 authentication, if required.

SNMPv1/v2c Community

Enter values Read community and Write community for SNMPv1/V2c authentication, if required.

Telnet

Use the Name and Password fields to change the account used to login via Telnet sessions.

SSH

Enter values in the required fields to change the account used to login via SSH. When you have finished making your configuration settings, click **Save**.

User Information

User Information			[C01]Outlet																															
Management	Name	Password	All	01	02	03	04	05	06	07	08	09	10	11	12	13	14	15	16	17	18	19	20	21	22	23	24	25	26	27	28	29	30	
Enable ▾	123456	*****																																
Disable ▾																																		
Disable ▾																																		
Disable ▾																																		
Enable ▾	654321	*****																																
Disable ▾																																		
Disable ▾																																		
Disable ▾																																		



To add a user, do the following:

1. Set the Management field to *Enable*.
2. Key in a name and password in the Name and Password fields.
3. Set the outlet-by-outlet permissions of the user in the Outlet field.
4. Click *Save* to save your settings.

Note: Values must be entered in both the Name and Password fields in order to enable an account.

The available options are explained in the following table:

Field	Description
Management	The Management field allows you to enable or disable a user's account: <ul style="list-style-type: none"> ◆ Enable – stores the user account ◆ Disable – disables the user account
Name	From 1 to 16 characters are allowed.
Password	From 1 to 16 characters are allowed.

Field	Description
Outlet	This field allows you to set the outlet-by-outlet permissions of the user. Click on the user/port icon to cycle through the three permissions options, as follows:
	 User has complete access to this outlet.
	 User has read-only access to this outlet.
	 User has no access to this outlet.
Save	Click this button to save your operation or changes

Chapter 7

Log

Log

The eco PDU keeps a record of all transactions that take place on its installation, and stores up to 1024 events at a any given time. The System Log page provides a powerful array of filters and functions that allow you to view and export the log file data, as well as be informed by SNMP Trap / Syslog / SMTP of specified events as they occur.

System Log | Notification Settings

Station List

Refresh | 25 | Event(s) per Page | Page 1 of 1

No.	Date/Time	Category	Severity	Station ID	User	Description
00001	2022-11-29 09:35:53	Authentication	Information	1	administrator	administrator 10.3.66.84 logged in
00002	2022-11-29 09:03:45	Authentication	Information	1	administrator	administrator 10.3.66.84 logged out
00003	2022-11-29 08:17:55	Authentication	Information	1	administrator	administrator 10.3.66.84 logged in
00004	2022-11-29 07:41:23	Authentication	Information	1	administrator	administrator 10.3.52.50 logged out
00005	2022-11-29 07:34:37	Device	Critical	1		Bank 2 breaker off
00006	2022-11-29 07:34:36	Authentication	Information	1	administrator	administrator 10.3.52.50 logged in
00007	2022-11-29 07:34:14	System	Notification	1		PDU get new IP address 10.3.52.123 from DHCP server
00008	2022-11-29 07:34:07	Device	Critical	1		Abnormal utility power
00009	2022-11-29 07:34:05	System	Information	1		Device was rebooted
00010	2022-11-28 19:57:51	System	Notification	1		PDU get new IP address 10.3.52.123 from DHCP server
00011	2022-11-28 14:04:00	Authentication	Information	1	administrator	administrator 10.0.90.23 logged out
00012	2022-11-28 09:07:02	Authentication	Information	1	administrator	administrator 10.0.90.23 logged in
00013	2022-11-25 01:30:42	Authentication	Information	1	administrator	administrator 10.0.90.23 session timed out
00014	2022-11-24 17:22:25	Authentication	Information	1	administrator	administrator 10.0.90.23 logged in
00015	2022-11-23 10:53:53	Authentication	Information	1	administrator	administrator 10.3.52.50 logged out
00016	2022-11-23 10:48:00	Device	Information	1	administrator	Station name was changed by administrator
00017	2022-11-23 10:47:30	System	Information	1	administrator	Device event log was cleared by administrator

Clear | First Page | Previous Page | Next Page | Last Page | Save

© Copyright 2022 ATEN @ International Co., Ltd.

The System Log Event List

- ◆ Clicking on a device in the sidebar displays its log events in the main panel's log event list.
- ◆ Clicking the **Refresh** button updates the log list with the latest events.
- ◆ The entry box to the right of the Refresh button lets you set the number of events displayed per page.
- ◆ The top right of the main panel shows the total number of pages in the log file, and the number of the page you are currently viewing.
- ◆ The buttons in the bottom row function as follows:
 - ◆ **Clear:**
Click to erase the contents of the log event list
 - ◆ **First Page:**
Click to go to the first page of the log event list
 - ◆ **Previous Page:**
Click to move to the previous page of the log event list
 - ◆ **Next Page:**
Click to move to the next page of the log event list
 - ◆ **Last Page:**
Click to move to the last page of the log event list
 - ◆ **Save:**
Click to export and save the contents of the log event list as an exported file. Select to save as a .csv file or a .txt file, and click Save again to export it.

Notification Settings

The Notification Settings page is used to specify which of the eco PDU's components will receive notification of a log event. When you click the Notification Settings menu item, a page similar to the one below appears:

Event Log Settings

Event	Syslog	E-mail	SNMP
✓ Enable all system events	<input checked="" type="checkbox"/>	<input checked="" type="checkbox"/>	<input checked="" type="checkbox"/>
Log export succeeded	<input checked="" type="checkbox"/>	<input checked="" type="checkbox"/>	<input checked="" type="checkbox"/>
System event log (SEL) cleaned	<input checked="" type="checkbox"/>	<input checked="" type="checkbox"/>	<input checked="" type="checkbox"/>
F/W upgrade succeeded	<input checked="" type="checkbox"/>	<input checked="" type="checkbox"/>	<input checked="" type="checkbox"/>
F/W upgrade failed	<input checked="" type="checkbox"/>	<input checked="" type="checkbox"/>	<input checked="" type="checkbox"/>
Device configuration restore succeeded	<input checked="" type="checkbox"/>	<input checked="" type="checkbox"/>	<input checked="" type="checkbox"/>
Device configuration restore failed	<input checked="" type="checkbox"/>	<input checked="" type="checkbox"/>	<input checked="" type="checkbox"/>
Device configuration backup succeeded	<input checked="" type="checkbox"/>	<input checked="" type="checkbox"/>	<input checked="" type="checkbox"/>
Device configuration settings modified	<input checked="" type="checkbox"/>	<input checked="" type="checkbox"/>	<input checked="" type="checkbox"/>
Security settings modified	<input checked="" type="checkbox"/>	<input checked="" type="checkbox"/>	<input checked="" type="checkbox"/>
F/W upgrade started	<input checked="" type="checkbox"/>	<input checked="" type="checkbox"/>	<input checked="" type="checkbox"/>
Device rebooted	<input checked="" type="checkbox"/>	<input checked="" type="checkbox"/>	<input checked="" type="checkbox"/>
PDU get new IP address	<input checked="" type="checkbox"/>	<input checked="" type="checkbox"/>	<input checked="" type="checkbox"/>
Daisy chain station added	<input checked="" type="checkbox"/>	<input checked="" type="checkbox"/>	<input checked="" type="checkbox"/>
Daisy chain station removed	<input checked="" type="checkbox"/>	<input checked="" type="checkbox"/>	<input checked="" type="checkbox"/>
> Enable all Authentication events	<input checked="" type="checkbox"/>	<input checked="" type="checkbox"/>	<input checked="" type="checkbox"/>
> Enable all User Management events	<input checked="" type="checkbox"/>	<input checked="" type="checkbox"/>	<input checked="" type="checkbox"/>
> Enable all Device Management events	<input checked="" type="checkbox"/>	<input checked="" type="checkbox"/>	<input checked="" type="checkbox"/>

Save

- ◆ The event categories are listed in the left column.
 - ◆ When you first open the page, only the main category items appear. (Main category item rows have a gray background.)
 - ◆ Subcategory items are nested under the main category headings. Click the accordion in front of the main category headings to display the subcategory items. (Subcategory item rows have a white background.)
- ◆ Click the checkboxes under the column headings to select which component(s) will receive notification of the log events.
 - ◆ Clicking on a main category heading's row automatically selects all the subcategory items nested below it.
 - ◆ If you only want to set notification for some of the subcategory events, don't put a check in the main category row. Instead, drop down the subcategory list, and only check the subcategory events you want.
- ◆ When you have finished making your setting choices, click Save. When a specified log event occurs, notification of that event will be sent to the selected component.

When you have finished making your configuration settings, click **Save**.

This Page Intentionally Left Blank

Chapter 8 Setup

Device Management

The *Setup* page allows administrators and users with device management permission to configure and control the overall eco PDU operations.

Device Configuration

This page presents information about the device selected, as described in the following sections:

The screenshot shows the ATEN PG98330B2 device configuration interface. The top navigation bar includes 'Energy', 'User', 'Log', 'Setup', and 'PDU'. The 'Setup' page is active, showing the 'Device Configuration' section. On the left, a 'Station List' shows a list of stations, with the selected station '[C01] - [PG98330B2] PG98330B2_FOR_CA' highlighted. The main configuration area is titled 'General' and contains the following fields:

- PDU Name: PG98330B2_FOR_CA
- MAC Address: 00:10:74:25:10:04
- MAC Address: 00:10:74:25:10:05
- F/W Version: 1.0.086
- Rack Location name: [Empty text box]

Below the 'General' section, there are two sub-sections:

- Service Ports:** Includes radio buttons for 'Only HTTPs' (selected) and 'HTTP / HTTPs'. Below are input fields for 'HTTP: 80' and 'HTTPS: 443'.
- Serial Settings:** (Section header only, no visible fields)

© Copyright 2022 ATEN @ International Co., Ltd.

General

The detailed view of the 'General' configuration section shows the following fields:

- PDU Name: PG98330B2_FOR_CA
- MAC Address: 00:10:74:25:10:04
- MAC Address: 00:10:74:25:10:05
- F/W Version: 1.0.086
- Rack Location name: [Empty text box]

Item	Meaning
PDU Name	This field lets you rename the device as desired. Simply key in the name of your choice. Click Save (located at the bottom of the page) to save the new name.
MAC Address	This item displays the eco PDU's MAC address.
Firmware Version	This item displays the current firmware version. You can check if there are any newer versions available on the ATEN website.
Rack Location Name	This field lets you give the rack location a unique name for easy reference.

Service Ports

As a security measure, if a firewall is being used, the administrator can specify the port numbers that the firewall will allow. If a port other than the default is used, users must specify the port number as part of the IP address when logging in. If an invalid port number (or no port number) is specified, the eco PDU will not be found.

Select whether to allow only secure browser logins, as shown below:

Service Ports

Only HTTPS
 HTTP / HTTPS

HTTP:

HTTPS:

An explanation of the fields is given in the table below:

Field	Explanation
HTTP	The port number for a browser login. The default is 80.
HTTPS	The port number for a secure browser login. The default is 443.

- Note:**
1. Valid entries for all of the service ports are from 1 to 65535.
 2. The service ports cannot have the same value. You must set a different value for each.
 3. If there is no firewall (on an Intranet, for example), it doesn't matter what these numbers are set to, since they have no effect.

Serial Settings

In this field, you can configure the console mode and RS-485 serial port address for remote control from the hardware and software controller.

Serial Settings

Console Mode

RS485Serial Port Address:

IPv4 Configuration

The eco PDU's IPv4 IP and DNS addresses (the traditional method of specifying IP addresses) can either be assigned automatically (DHCP), or manually, by specifying a fix IP address.

IPv4 Configuration

Enable bridge

Ethernet1

- Obtain IP address automatically [DHCP]
- Set IP address manually [Fixed IP]

IP Address:

Subnet Mask:

Default Gateway:

- Obtain DNS server address automatically
- Set DNS server address manually

Preferred DNS Server:

Alternate DNS Server:

Ethernet2

- Obtain IP address automatically [DHCP]
- Set IP address manually [Fixed IP]

IP Address:

Subnet Mask:

Default Gateway:

- Obtain DNS server address automatically
- Set DNS server address manually

Preferred DNS Server:

Alternate DNS Server:

Enable DHCP server

IP Pool Starting Address:

IP Pool Ending Address:

- ◆ For dynamic IP address assignment, select the *Obtain IP address automatically* radio button. (This is the default setting.)
- ◆ To specify a fixed IP address, select the *Set IP address manually* radio button and fill in the IP address with values appropriate for your network.
- ◆ For automatic DNS Server address assignment, select the *Obtain DNS Server address automatically* radio button.
- ◆ To specify the DNS Server address manually, select the *Set DNS server address manually* radio button, and fill in the addresses for the Preferred and Alternate DNS servers with values appropriate for your network.

-
- Note:** 1. If you choose *Obtain IP address automatically*, when the device starts up, it shall wait for its assigned IP address from the DHCP server. If it hasn't obtained an IP address after one minute, it automatically reverts to its default IP address (192.168.0.60.)
2. If the device is on a network that uses DHCP to assign network addresses, and you need to ascertain its IP address, see *IP Address Determination*, page 110.
3. Specifying the Alternate DNS Server address is optional.
-

IPv6 Configuration

The eco PDU's IPv6 IP and DNS addresses (the traditional method of specifying IP addresses) can either be assigned automatically (DHCP), or manually, by specifying a fix IP address.

IPv6 Configuration

Ethernet1

Enable autoconfiguration

Set configuration manually

IP Address:

Static Prefix Length:

Default Gateway:

Use DHCPv6 to obtain DNS Server Addresses

Set DNS server address manually

Preferred DNS Server:

Alternate DNS Server:

Ethernet2

Enable autoconfiguration

Set configuration manually

IP Address:

Static Prefix Length:

Default Gateway:

Use DHCPv6 to obtain DNS Server Addresses

Set DNS server address manually

Preferred DNS Server:

Alternate DNS Server:

- ◆ For dynamic IP address assignment, select the *Enable autoconfiguration* radio button. (This is the default setting.)
- ◆ To specify a fixed IP address, select the *Set configuration manually* radio button and fill in the IP address with values appropriate for your network.
- ◆ For automatic DNS Server address assignment, select the *Use DHCPv6 to obtain DNS Server Addresses* radio button.
- ◆ To specify the DNS Server address manually, select the *Set DNS server address manually* radio button, and fill in the addresses for the Preferred and Alternate DNS servers with values appropriate for your network.

- Note:** 1. If you choose *Obtain IP address automatically*, when the device starts up, it shall wait for its assigned IP address from the DHCP server. If it hasn't obtained an IP address after one minute, it automatically reverts to its default IP address (192.168.0.60.)
2. If the device is on a network that uses DHCP to assign network addresses, and you need to ascertain its IP address, see *IP Address Determination*, page 110.
3. Specifying the Alternate DNS Server address is optional.
-

Event Notification

The Event Notification section is divided into three sections: SMTP Settings, SNMP Trap Receivers, and Syslog Server. Each section is described below.

Note: SMTP communications are supported on Port 25.

SMTP Server

Event Notification

SMTP Server

Enable report from the following SMTP Server

SMTP Server:

SMTP Port Number:

My server requires authentication

Account Name:

Password:

Enable secure connection (STARTTLS)

From:

To:

To have the eco PDU device send e-mail reports from the SMTP server, do the following:

1. Check *Enable report from the following SMTP server*, and key in the IP address of your SMTP server.
 2. If your server requires authentication, check the *My server requires authentication* checkbox.
 3. Key in the appropriate account information in the *Account Name*, *Password*, and *From* fields.
-

Note: Only one email address is allowed in the *From* field, and it cannot exceed 64 characters.)

4. (Optional) To enable TLS encryption on your notifications, check the **Enable secure connection (STARTTLS)** checkbox. We support TLS1.0, TLS1.1, and TLS1.2.
5. Key in the e-mail address(es) of where you want the event reports to be sent in the *To* field.

Note: If you are sending the report to more than one e-mail address, separate the addresses with a semicolon or comma, depending on the specified mail server. The total cannot exceed 256 characters.

SNMP Trap Receivers

SNMP Trap Receiver

Enable SNMP Trap SNMPv3 SNMPv2c SNMPv1

Receiver IP 1:

Service Port 1:

Community 1:

User name 1:

Auth-password 1:

Priv-Password 1:

Receiver IP 2:

Service Port 2:

Community 2:

User name 2:

Auth-password 2:

Priv-Password 2:

Up to four SNMP management stations can be specified. If you want to send out SNMP trap notifications, do the following:

1. Check *Enable SNMP Trap*.
2. Select which version of SNMP you want to use.
3. Key in the IP address(es) and the service port number(s) of the computer(s) to be notified by the SNMP trap events. The valid port range is 1–65535, with the default port value being 162.

Note: Make sure that the port number you specify here matches the port number used by the SNMP receiver computer.

4. Key in the community value(s) if required by the version of SNMP (SNMPv1 and SNMPv2c) used.
5. Key in the auth/privacy password(s) that correspond to each of the stations by the version of SMP (SNMPv3) used.

Syslog Server

Syslog Server

Enable Syslog Server

Server IP:

Service Port:

To record all events that take place on the eco PDU devices, and write them to the eco PDU Syslog server, do the following:

1. Check **Enable Syslog Server**.
2. Key in the IP address and port number of the Syslog server. The valid port range is 1-65535. The default port value is 514.

Date/Time

The Date/Time dialog page sets the eco PDU's time parameters:

Date Time

Time Zone

(UTC-12:00) Eniwetok Kwajalein

Daylight Savings Time

Manual Input

Date: (YYYY-MM-DD)

Time: (HH:MM:SS)

Sync with PC

Network Time

Enable auto adjustment

AU | ntp1.cs.mu.OZ.AU

Preferred custom server IP:

Alternate time server:

AU | ntp1.cs.mu.OZ.AU

Alternate custom server IP:

Adjust time every days

Set the parameters according to the information described below.

Time Zone

Time Zone

(UTC-12:00) Eniwetok Kwajalein 

Daylight Savings Time

- ◆ To establish the time zone that the eco PDU is located in, use the *Time Zone* drop-down menu to choose the city that most closely corresponds to where it is at.
- ◆ If your country or region employs daylight saving time (summer time), check the corresponding checkbox.

Manual Input

Manual Input

Date: (YYYY-MM-DD) 

Time: (HH:MM:SS)

Sync with PC

Use this section to specify the eco PDU's date and time manually.

- ◆ Click the calendar icon and select a calendar entry for the date.
- ◆ Key the time into the *Time* field, using the HH:MM:SS (hours, minutes, seconds) format.

Note: This section is only enabled when *auto adjustment* (in the *Network Time* section) is disabled (unchecked).

As an alternative to specifying the date and time by entering them into the date and time fields, you can check the *Sync with PC* checkbox, where the eco PDU will take its date and time settings from the locally connected PC.

Network Time

Network Time

Enable auto adjustment

AU | ntp1.cs.mu.OZ.AU

Preferred custom server IP:

Alternate time server:

AU | ntp1.cs.mu.OZ.AU

Alternate custom server IP:

Adjust time every days

[Adjust Time Now](#)

To have the time automatically synchronized to a network time server, do the following:

1. Check the *Enable auto adjustment* checkbox.

2. Select your preferred time server

– or –

Check the *Preferred custom server IP* checkbox, and key in the IP address of the time server of your choice.

3. If you want to configure an alternate time server, check the *Alternate time server* checkbox, and repeat step 2 for the alternate time server entries.

4. Key in your choice for the number of days between synchronization procedures.

Finishing Up

When you have finished making your settings on this page, click **Save**.

After you have saved your changes, click **Adjust Time Now** to synchronize immediately according to the time settings.

Security

The Security page controls access to the eco PDU.

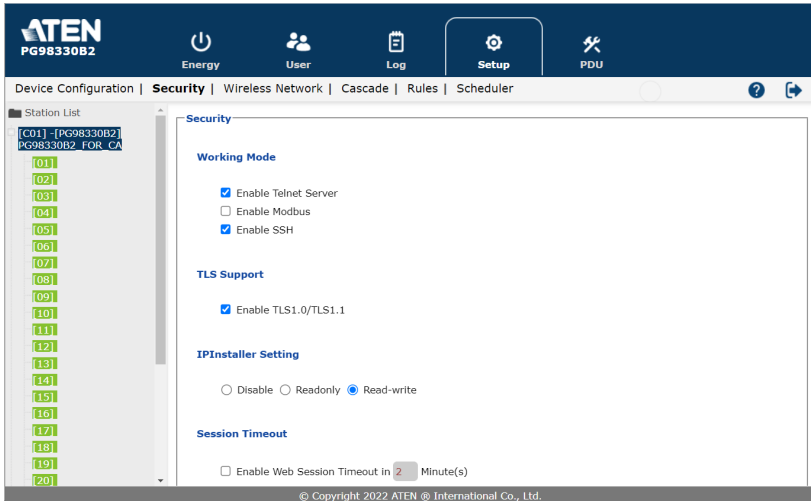

Working Mode

Working Mode

- Enable Telnet Server
- Enable Modbus
- Enable SSH

- ◆ If Enable Telnet Server is checked, the eco PDU is accessible via a Telnet sessions using the Telnet username and password (see Telnet, page 25).
- ◆ If Enable Modbus is checked, the eco PDU is accessible and the measurements of the eco PDU such as current, voltage, power, temperature, humidity, and pressure can be read via the Modbus communications protocol.
- ◆ If Enable SSH is checked, the PDU is accessible and the measurements of the PDU such as current, voltage, power, temperature, humidity, and pressure can be read via the SSH cryptographic network protocol.

TLS Support

TLS Support

- Enable TLS1.0/TLS1.1

- ◆ If TLS Support is checked, the PDU is accessible on older computers or older web browsers that support TLS1.0 or TLS1.1 data encryption.

IP Installer Setting

IP Installer Setting

Disable Readonly Read-write

- ◆ If Disable is checked, the IP address of the eco PDU cannot be found by the IP Installer software.
- ◆ If Readonly is checked, the IP address of the eco PDU can be found but not configurable by the IP Installer software.
- ◆ If Read-write is checked, the IP address of the eco PDU can be found and configurable by the IP Installer software.

Session Timeout

Session Timeout

Enable Web Session Timeout in Minute(s)

- ◆ If Enable Web Session Timeout in is checked, a user's web session will logout due to inactivity after the number of Minute(s) entered (1–5) is surpassed.

Account Policy

The Account Policy section governs policies in regard to the login usernames and passwords.

Account Policy

Minimum Username Length:

Minimum Password Length:

Password Must Contain At Least:

- One Upper Case
- One Lower Case
- One Number

Disable Duplicate Login

Check a policy and enter the required information in the appropriate fields.

Item	Description
Minimum Username Length	Sets the minimum number of characters required for a username. Acceptable values are from 1 to 16.
Minimum Password Length	Sets the minimum number of characters required for a password. Acceptable values are from 1 to 16.
Password Must Contain At Least	Checking any of these items requires users to include at least one of the specified items in their password. Note: This policy does not affect existing user accounts. Only new user accounts created after this policy has been enabled, and users required to change their passwords are affected.
Disable Duplicate Login	Check this to prevent users from logging in with the same account at the same time.

IP Filter / Mac Filter

IP Filter/MAC Filter

IP Filter Enable
 Include
 Exclude

MAC Filter Enable
 Include
 Exclude

◆ IP Filter / MAC Filter

If any filters have been configured, they appear in the IP Filter and/or MAC Filter list boxes.

IP and MAC Filters control access to the eco PDU based on the IP and/or MAC addresses of the client computers attempting to connect. A maximum of 5 IP filters and 5 MAC filters are allowed.

To enable IP and/or MAC filtering, check the *IP Filter Enable* and/or *MAC Filter Enable* checkbox.

- ◆ If the include button is checked, all addresses within the filter range are allowed access, while all other addresses are denied access.

- ◆ If the exclude button is checked, all addresses within the filter range are denied access, while all other addresses are allowed access.

Adding Filters

To add an IP filter, do the following:

1. Click **Add**. A dialog box similar to the one below appears:

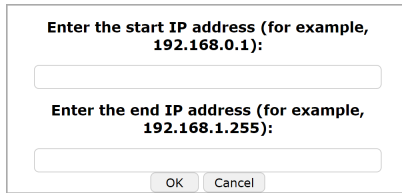

A dialog box with a white background and a thin grey border. It contains two text input fields. The first field is preceded by the text "Enter the start IP address (for example, 192.168.0.1):". The second field is preceded by the text "Enter the end IP address (for example, 192.168.1.255):". At the bottom of the dialog box, there are two buttons: "OK" and "Cancel".

2. Specify the start filter address in the dialog box (for example, 192.168.0.200), then click **OK**.
3. To filter a single IP address, key in the same address as the start IP. To filter a continuous range of addresses, key in the end number of the range (for example, 192.168.0.225).
4. After filling in the address, click **OK**.

Repeat these steps for any additional IP address ranges you want to filter.

To add a MAC filter, do the following:

1. Click **Add**. A dialog box similar to the one below appears:



A dialog box with a white background and a thin grey border. It contains one text input field preceded by the text "Enter the MAC address (for example, 004854655511):". At the bottom of the dialog box, there are two buttons: "OK" and "Cancel".

2. Specify the MAC address in the dialog box (for example, 001074670000), then click **OK**.

Repeat these steps for any additional MAC addresses you want to filter.

IP Filter / MAC Filter Conflict

If there is a conflict between an IP and MAC filter — for example, where a computer’s IP address is allowed by the IP filter but its MAC address is excluded by the MAC filter — then that computer’s access is blocked. In other words, if either filter blocks a computer, then the computer is blocked, no matter what the other filter is set to.

Modifying Filters

To modify a filter, select it in the IP Filter or MAC Filter list box and click **Modify**. The Modify dialog box is similar to the Add dialog box. When it comes up, simply delete the old address(es) and replace it with the new one(s).

Deleting Filters

To delete a filter, select it in the IP Filter or MAC Filter list box and click **Delete**.

Authentication & Authorization

The Authentication & Authorization field is used to set up login authentication and authorization management from external sources.

Authentication & Authorization

Auth Type:	None
◆ RADIUS Settings	
Auth Type:	RADIUS
RADIUS Settings	
Preferred RADIUS Server IP:	
Preferred RADIUS Service Port:	1812
Alternate RADIUS Server IP:	
Alternate RADIUS Server Port:	1645
Timeout:	3
Retries:	3
Shared Secret (at least 6 characters):	

To allow authentication and authorization for the eco PDU device through a RADIUS server, do the following:

1. Use the drop-down menu and select **RADIUS**.
2. Fill in the IP addresses and service port numbers for the Preferred and Alternate RADIUS servers. The default port number for the Preferred server is 1812; the default port number for the Alternate server is 1645.

Note: Make sure that the port numbers you specify here match the port numbers used by the RADIUS servers.

3. In the *Timeout* field, set the time in seconds that the eco PDU device shall wait for the RADIUS server to reply before it times out. The default timeout is 3 seconds.
4. In the *Retries* field, set the number of allowed retries for attempting to connect to the RADIUS server. The default retries is 3 times.
5. In the *Shared Secret* field, key in the character string that you want to use for authentication between the eco PDU device and the RADIUS Server.
6. On the RADIUS server, set the entry for each user as follows:

su/xxxx

Where *xxxx* represents the username given to the user when the account was created on the eco PDU device. The user's access rights equivalent to the ones assigned for the eco PDU device. (See *Device Management*, page 61.)

Note: su/user supports view ports only; su/administrator supports all eco PDU functions.

◆ LDAP Settings

Auth Type:	<input type="text" value="LDAP"/>
LDAP Settings	
Type of LDAP Server:	<input type="text" value="OpenLDAP"/>
Security:	<input type="text" value="NONE"/>
IP address/hostname:	<input type="text"/>
Port:	<input type="text" value="389"/>
Bind DN:	<input type="text"/>
Password:	<input type="text"/>
Login Name Attribute:	<input type="text"/>
Base DN:	<input type="text"/>
User entry object class:	<input type="text"/>
Login Attribute:	<input type="text"/>
Timeout:	<input type="text" value="3"/> sec

To allow authentication and authorization for the eco PDU device through a LDAP server, do the following:

1. Use the drop-down menu and select **LDAP**.

2. Select a Type of LDAP Server and Security option and fill in the IP addresses/hostname, port numbers, Bind DN, Password, Login Name Attribute, Base DN, User entry object class, and Login Attribute for the LDAP servers. The default port number is 389.

Note: Make sure that the port numbers you specify here match the port numbers used by the LDAP servers.

3. In the *Timeout* field, set the time in seconds that the eco PDU device shall wait for the LDAP server to reply before it times out. The default timeout is 3 seconds.
4. On the LDAP server, set the entry for each user as follows:

su/xxxx

Where *xxxx* represents the username given to the user when the account was created on the eco PDU device. The user's access rights equivalent to the ones assigned for the eco PDU device. (See *Device Management*, page 61.)

Note: su/user supports view ports only; su/administrator supports all eco PDU functions.

◆ TACACS+ Settings

Auth Type:	TACACS+ <input type="text"/>
TACACS PLUS Settings	
Preferred TACACS PLUS Server IP:	<input type="text"/>
Preferred TACACS PLUS Service Port:	<input type="text" value="49"/>
Alternate TACACS PLUS Server IP:	<input type="text"/>
Alternate TACACS PLUS Server Port:	<input type="text" value="49"/>
Timeout:	<input type="text" value="3"/> sec
Retries:	<input type="text" value="3"/>
Shared Secret (at least 6 characters):	<input type="text"/>

To allow authentication and authorization for the eco PDU device through a TACACS+ server, do the following:

1. Use the drop-down menu and select **TACACS+**.
2. Fill in the IP addresses and service port numbers for the Preferred and Alternate TACACS+ servers. The default port number for the Preferred server is 49; the default port number for the Alternate server is 49.

Note: Make sure that the port numbers you specify here match the port numbers used by the TACACS+ servers.

3. In the *Timeout* field, set the time in seconds that the eco PDU device shall wait for the TACACS+ server to reply before it times out. The default timeout is 3 seconds.
4. In the *Retries* field, set the number of allowed retries for attempting to connect to the TACACS+ server. The default retries is 3 times.
5. In the *Shared Secret* field, key in the character string that you want to use for authentication between the eco PDU device and the TACACS+ Server.
6. On the TACACS+ server, set the entry for each user as follows:

su/xxxx

Where *xxxx* represents the username given to the user when the account was created on the eco PDU device. The user's access rights equivalent to the ones assigned for the eco PDU device. (See *Device Management*, page 61.)

Note: su/user supports view ports only; su/administrator supports all eco PDU functions.

Private Certificate

Private Certificate

Private Key:

Certificate:

When logging in over a secure (SSL) connection, a signed certificate is used to verify that the user is logging in to the intended site. For enhanced security, the *Private Certificate* section allows you to use your own private encryption key and signed certificate, rather than the default ATEN certificate.

There are two methods for establishing your private certificate: generating a self-signed certificate or importing a third-party certificate authority (CA) signed certificate.

♦ Generating a Self-Signed Certificate

If you wish to create your own self-signed certificate, a free utility — `openssl.exe` — is available for download over the web.

♦ Obtaining a CA Signed SSL Server Certificate

For better ensured security, we recommend using a third-party certificate authority (CA) signed certificate. To obtain a third-party signed certificate, go to a CA (Certificate Authority) website to apply for an SSL certificate. After the CA sends you the certificate and private encryption key, save them to a convenient location on your computer.

♦ Importing the Private Certificate

To import the private certificate, do the following:

1. Click **Browse** to the right of *Private Key* to locate the location path of the private encryption key file, and select it.
2. Click **Browse** to the right of *Certificate* to locate the location path of the certificate file, and select it.
3. Click **Upload** to complete the procedure.

Note: 1. Clicking **Restore Default** returns the device to using the default ATEN certificate.

2. Both the private encryption key and the signed certificate must be imported at the same time.
-

When you have finished making your settings on this page, click **Save**.

Wireless Network

The Wireless Network page allows you to enable the Wi-Fi capability of the eco PDU.

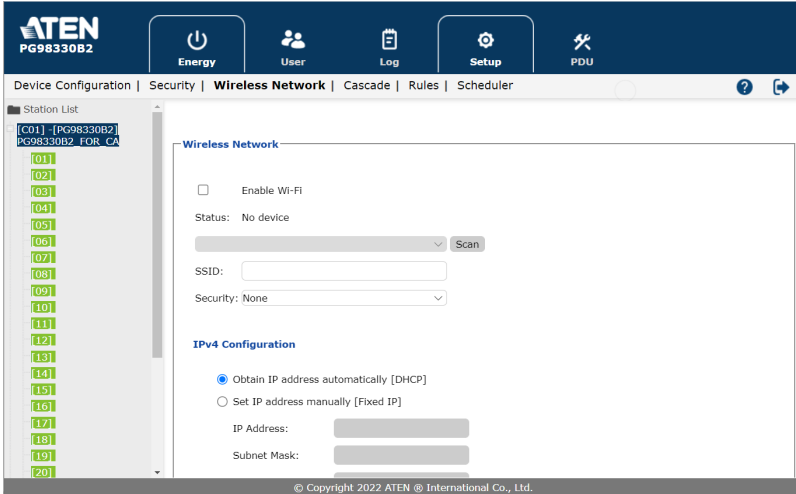

Wireless Network

Wireless Network

Enable Wi-Fi

Status: No device

SSID:

Security: None

Item	Description
Enable Wi-Fi	Check to enable the Wi-Fi function on the eco PDU.
Scan	Once the Wi-Fi adapter is connected to the eco PUD's USB Type-A port, click Scan to scan for any available wireless network in your area.
SSID	Manually key in the SSID of the wireless network you want to connect to.
Security	Use the drop-down menu to select a security type for your wireless network, and manually key in the password.

IPv4 Configuration

The eco PDU's IPv4 IP and DNS addresses (the traditional method of specifying IP addresses) can either be assigned automatically (DHCP), or manually, by specifying a fix IP address.

IPv4 Configuration

Obtain IP address automatically [DHCP]
 Set IP address manually [Fixed IP]

IP Address:
 Subnet Mask:
 Default Gateway:

Obtain DNS server address automatically
 Set DNS server address manually

Preferred DNS Server:
 Alternate DNS Server:

- ◆ For dynamic IP address assignment, select the *Obtain IP address automatically* radio button. (This is the default setting.)
- ◆ To specify a fixed IP address, select the *Set IP address manually* radio button and fill in the IP address with values appropriate for your network.
- ◆ For automatic DNS Server address assignment, select the *Obtain DNS Server address automatically* radio button.
- ◆ To specify the DNS Server address manually, select the *Set DNS server address manually* radio button, and fill in the addresses for the Preferred and Alternate DNS servers with values appropriate for your network.

-
- Note:**
1. If you choose *Obtain IP address automatically*, when the device starts up, it shall wait for its assigned IP address from the DHCP server. If it hasn't obtained an IP address after one minute, it automatically reverts to its default IP address (192.168.0.60.)
 2. If the device is on a network that uses DHCP to assign network addresses, and you need to ascertain its IP address, see *IP Address Determination*, page 110.
 3. Specifying the Alternate DNS Server address is optional.
-

IPv6 Configuration

The eco PDU's IPv6 IP and DNS addresses (the traditional method of specifying IP addresses) can either be assigned automatically (DHCP), or manually, by specifying a fix IP address.

IPv6 Configuration

Enable autoconfiguration
 Set configuration manually

IP Address:
Static Prefix Length:
Default Gateway:

Use DHCPv6 to obtain DNS Server Addresses
 Set DNS server address manually

Preferred DNS Server:
Alternate DNS Server:

- ◆ For dynamic IP address assignment, select the *Enable autoconfiguration* radio button. (This is the default setting.)
- ◆ To specify a fixed IP address, select the *Set configuration manually* radio button and fill in the IP address with values appropriate for your network.
- ◆ For automatic DNS Server address assignment, select the *Use DHCPv6 to obtain DNS Server Addresses* radio button.
- ◆ To specify the DNS Server address manually, select the *Set DNS server address manually* radio button, and fill in the addresses for the Preferred and Alternate DNS servers with values appropriate for your network.

-
- Note:** 1. If you choose *Obtain IP address automatically*, when the device starts up, it shall wait for its assigned IP address from the DHCP server. If it hasn't obtained an IP address after one minute, it automatically reverts to its default IP address (192.168.0.60.)
2. If the device is on a network that uses DHCP to assign network addresses, and you need to ascertain its IP address, see *IP Address Determination*, page 110.
3. Specifying the Alternate DNS Server address is optional.
-

Cascade

The Cascade page allows you to manage and cascade eco PDU in your installation.

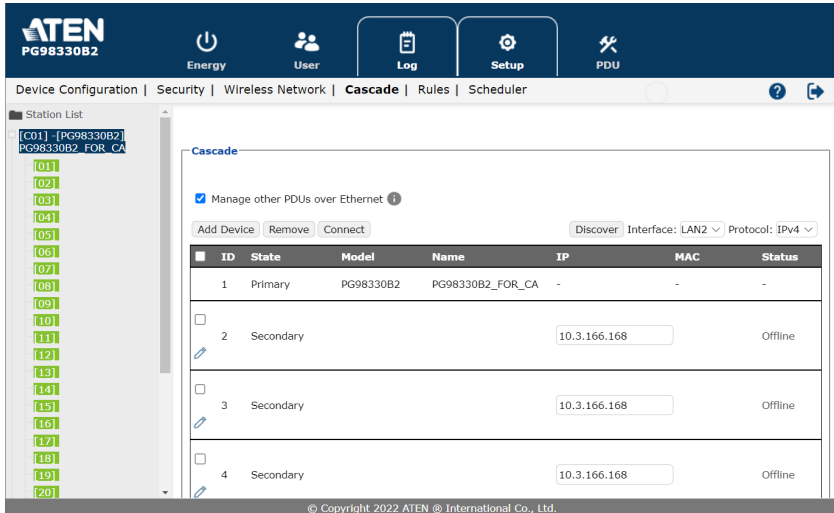

Adding a PDU

To add a cascade PDU, do the following:

1. Click **Add Device**. A dialog box similar to the one below appears:

Add PDU
Test Connection

ID:

IP:

User name:

Password:

Add
Cancel

2. Specify the ID, IP address, username, and password in the dialog box, then click **Add**.
3. (Optional) You may test the connection between to cascade eco PDU before you click Add.

Deleting a PDU

To delete a cascaded PDU, do the following:

1. Check the checkbox(s) beside the ID column of the eco PDU(s) you want to remove.
2. Click **Remove**.

Connecting a PDU

To connect to a cascaded PDU, do the following:

1. Check the checkbox(s) beside the ID column of the eco PDU(s) you want to connect.
2. Click **Connect**.

Discovering

<input type="checkbox"/>	Model	Name	IP	MAC	Username	Password
<input checked="" type="checkbox"/>	PG95330B2	PG95330B2_FOR_CA	10.3.52.151	00:10:74:25:11:4B	<input type="text"/>	<input type="text"/>

To discover a cascaded PDU in your installation, do the following:

1. Check the checkbox beside discover and key in the username and password information.
2. Click **Discover**.

Rules

The Rules page allows you to manage and set rules for the eco PDU in your installation.

Item	Description
Enable	Check to enable the rule you configured for your eco PDU.
Name	This field lets you name the rules.
Detail	Click to bring up more options to configure the rules.
Delete	Click the bin icon to remove the rules.
Add	Click to add more Station Source, Sequence Station, or Rules.

Scheduler

Use the *Scheduler* page to power on, power off, or reboot the eco PDU.

The screenshot shows the ATEN PG95330B2 Scheduler configuration interface. The top navigation bar includes 'Energy', 'User', 'Log', 'Setup', and 'PDU'. The 'Scheduler' page is active, displaying a 'Station List' on the left and a main configuration area. The 'Events' section contains two event entries:

Event Name	Frequency	Time	Duration	Actions	Status
Event A	Daily	00:00		A,B	Off
Event B	Monthly	00:00	30	D	On

The 'Actions' section contains four action entries:

Action Name	Operation Time	Action	Target Outlets
A	Immediately	Power OFF	outlet 01
B	Immediately	Power ON	outlet 02,04,06,08
C	Use Delay Time	Power Reboot	outlet 01,03,05,07,09
D	Use Delay Time	Power OFF	outlet 01,02,03

© Copyright 2022 ATEN ® International Co., Ltd.

Creating an Event

To create an event, do the following:

1. Go to Setup > Scheduler.
2. Create one or more power-on, power-off, and/or reboot actions. These actions will be selectable when configuring an event.
 - a) Click +Create Action.
 - b) In the pop-up screen, name the action, and use the drop-down lists to configure the action and the target outlet(s).

← Create Action

Action Name

Action

outlets

c) Click Save. The action is added to the list.

Actions

+ Create Action

Action Name	Operation Time	Action
A	Immediately	Power OFF outlet 01
B	Immediately	Power ON outlet 02,04,06,08
C	Use Delay Time	Power Reboot outlet 01,03,05,07,09
D	Use Delay Time	Power OFF outlet 01,02,03
E	Immediately	Power ON outlet 28,29,30

3. Create an event.

a) Click +Create Event.

b) In the pop-up screen, name the event, and then configure the schedule and action as needed.

← Create Event

Event Name

Scheduled Time :

Actions

Action Name	Operation Time	Action
-------------	----------------	--------

c) Click Save. The event is added to the event list. Use the toggle button to enable/disable created events.

Events

+ Create Event

Event Name	Frequency	Time	Duration	Actions	Toggle
Event A	Daily	00:00		A,B	<input checked="" type="checkbox"/>
Event B	Monthly	00:00	30	D	<input checked="" type="checkbox"/>

This Page Intentionally Left Blank

PDU

The *PDU* function is used to upgrade the eco PDU's firmware, and to backup and restore the device's configuration settings.

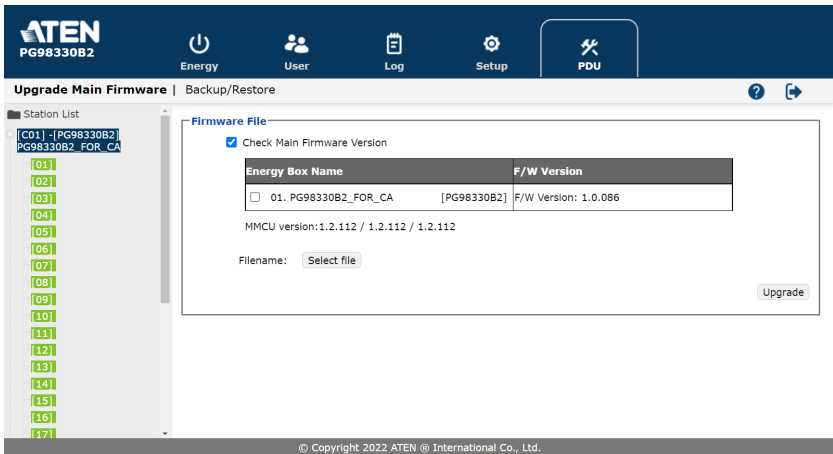

Upgrade Main Firmware

The *Upgrade Main Firmware* page is used to upgrade the firmware of the eco PDU.

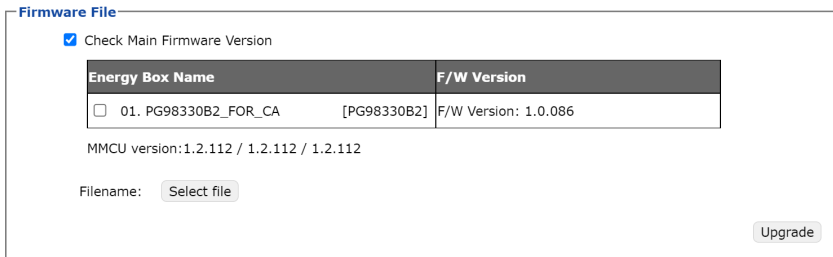

Firmware File

When you click the Upgrade Main Firmware tab, the display opens with the Firmware file menu page, which looks similar to the one below:

Firmware File

Check Main Firmware Version

Energy Box Name	F/W Version
<input type="checkbox"/> 01. PG98330B2_FOR_CA [PG98330B2]	F/W Version: 1.0.086

MMCU version: 1.2.112 / 1.2.112 / 1.2.112

Filename:

A description of the items shown in this panel are given in the table below:

Item	Description
Check Main Firmware Version	If you enable <i>Check Main Firmware Version</i> , the eco PDU's current firmware compared with that of the upgrade file. If the current version is equal to or higher than the upgrade version, a popup message appears, to inform you of the situation and stops the upgrade procedure.
Name	Lists all of the eco PDU devices. Check the checkboxes of the devices for which you want to upgrade.
F/W Version	Displays the eco PDU's current firmware version.
Filename	As new versions of the firmware become available, they are posted onto our website for users to download. Click the <i>Browse</i> button to select the downloaded upgrade file.
Upgrade	Click this button to upgrade the firmware of the selected devices.

◆ Upgrading the Firmware

To upgrade the firmware, refer to the UI snapshot on the preceding page, and do the following:

1. Go to our website and download the firmware upgrade file to a convenient location on your computer.
2. Click the *Browse* button to locate and select the downloaded firmware upgrade file.
3. Click **Upgrade** to start the upgrade procedure.
 - ◆ If you enabled *Check Main Firmware Version*, the current firmware is compared with that of the upgrade file. If the current version is equal to or higher than the upgrade version, a popup message appears, to inform you of the situation and stops the upgrade procedure.

- ◆ If you didn't enable *Check Main Firmware Version*, the upgrade file is installed without comparing.
 - ◆ Once the upgrade completes successfully, the switch restarts automatically.
4. Log in again, and check the firmware version to be sure it is the new one.

◆ Firmware Upgrade Recovery

Should the eco PDU's firmware upgrade procedure fail, and the device becomes unusable, the following firmware upgrade recovery procedure will resolve the problem:

1. Power off the device.
2. Press and hold the Reset Switch in (see page 21).
3. While holding the Reset Switch in, power the switch back on.

This causes the switch to use the original factory installed main firmware version. Once the switch is operational, you can try upgrading the firmware again.

Backup/Restore

Selecting Backup/Restore on the menu bar gives you the ability to back up the switch's configuration and user profile information:

Station List

Station List lists the eco PDU only.

Station List	
Energy Box Name	Filename
<input type="checkbox"/> 01. PG98330B2_FOR_CA [PG98330B2]	Please select a file to restore ▾

Backup

Backup

Password:

Save

To backup the device's settings, do the following:

1. In the *Password* field, key in a password for the setting file to be backed up.

Note: Entering a password is optional. If you do enter a password, make a note of it, since you will need it to be able to restore the file.

2. Click **Save**.
3. When the browser asks what you want to do with the file, select *Save to disk*; then save it in a convenient location.

Restore

Restore

Auto Mapping

Password:

Filename:

To restore a previous backup, do the following:

1. Click **Browse**, navigate to the file and select it.

Note: If you have renamed the file, you can leave the new name as is. There is no need to return it to its original name.

2. In the *Password* field, key in the same password that you used to save the file.

Note: If you did not set a password when you created the backup file, you can omit this step.

3. Select as many of the options presented as you wish to restore.
4. Click **Restore**.

After the file is restored, a message appears to inform you that the procedure has completed successfully.

Chapter 10

Telnet Commands

Remote Terminal Operations

With ATEN eco PDU you can log in remotely from a computer using Telnet interface that allows system control through a high-end controller or PC.

Telnet

Telnet is a program that connects to a device over a network to provide text-based management and control. Telnet provides some of the same management features found in the eco PDU's web GUI. You can reference the eco PDU's web GUI functions by downloading the user manual from our website (www.aten.com). This can help you as you work your way through the text-based commands used to control the eco PDU that are discussed in this guide.

Telnet is available on all eco PDUs installed with the latest firmware. You can log in to the eco PDU via Telnet from any computer connected to the same network.

Setup

Log in to the eco PDU's web GUI, go to the **Setup** tab and click **Security** from the menu bar. Under **Working Mode**, check *Enable Telnet Server* and then click **Save** at the bottom of the page.

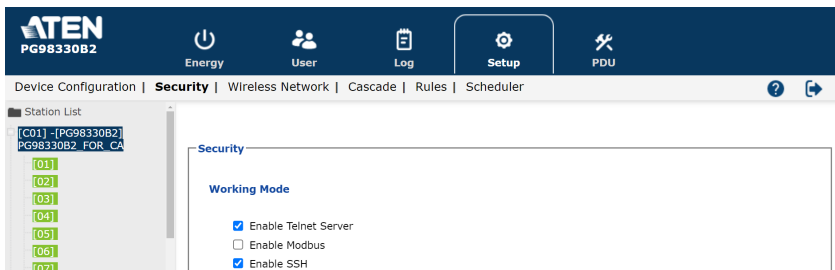

Note: If the *Enable Telnet Server* option is not available, please download the latest firmware from our website.

Logging In

To log in to the eco PDU via Telnet, do the following:

1. On your computer, open the start menu and select **Run**. Type: *cmd*

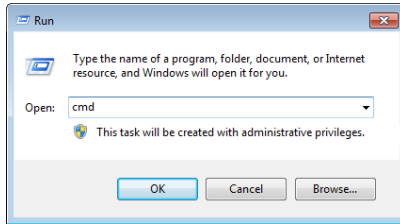

Click **OK**.

2. At the command prompt, key in *telnet* and the IP Address of the PDU, as follows:

```
telnet [IP Address]
```

3. Press **Enter**. The login screen appears:

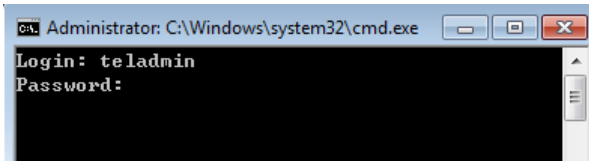

4. At the login prompt, enter the username: **teladmin**; and the password: **telpwd**.

Note: The Telnet username and password can be configured on the User tab of the eco PDU's web GUI.

5. When the Telnet session is established, *Logged in successfully* appears along with the command line prompt:

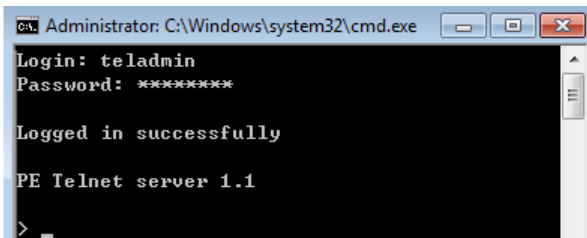

Session Timeout

A live Telnet connection would be terminated if there is no incoming data with 60 Seconds.

Commands

Use the Telnet commands to view and configure the eco PDU as described in each section. The text-based command line provides some of the same functions found under the Energy tab of the eco PDU's web-based GUI. Commands to view and configure the eco PDU are provide in the following sections. You can reference information provided in the user manual for the functions as you use the commands.

Verification

After sending an incorrect command, a verification message appears at the end of the command line.

- ◆ **Invalid command or exceed max command length:** The command has the wrong format and/or values. Try typing in the command string again using the correct format and/or values.

Read Power Outlet Status

The Read Power Outlet Status command allows you to view the power status of an outlet on the eco PDU.

The formula for Read Outlet Status commands is as follows:

Command + Outlet + Number + Option + [Enter]

1. For example, if you want to read the status of outlet 01 with a simple return string, type the following:

read status o01 simple [Enter]

2. For example, if you want to read the status of outlet 12 with a format return string, type the following:

read status o12 format [Enter]

The following tables show the possible values for the Read Outlet Status commands:

Command	Description
read status	Read status command

Outlet	Description
o	Outlet command
xx	PDU Outlet number xx: Outlet on PDU (01–04) Example: o02

Option	Description
simple	Return simple string of the selected power outlet status
format	Return format string of the selected power outlet status

The following table lists the available Read Outlet Status commands:

Command	Outlet	Option	Enter	Description
read status	oXX	simple	[Enter]	Read the status of outlet XX with a simple return string. XX: Outlet number (01–04)
read status	oXX	format	[Enter]	Read the status of outlet XX with a format return string. XX: Outlet number (01–04)

Note: 1. Each command string can be separated with a space.

2. The **Option** command string can be skipped and **format** will be used by default.

Switch Outlet Status

The Switch Outlet Status command allows you to change the power status of an outlet on the eco PDU.

The formula for Switch Outlet Status commands is as follows:

Command + Outlet + Number + Option + Control + [Enter]

1. For example, if you want to switch off outlet 04 immediately, type the following:

sw o04 imme off [Enter]

2. For example, if you want to switch on outlet 01 with the time delay set for the outlet, type the following:

sw o01 delay on [Enter]

3. For example, if you want to reboot outlet 03, type the following:

sw o03 reboot [Enter]

The following tables show the possible values for the Switch Outlet Status commands:

Command	Description
sw	Switch outlet status command

Outlet	Description
o	Outlet command
xx	PDU Outlet number xx: Outlet on PDU (01–04) Example: o02

Option	Description
imme	Switch outlet status immediately
delay	Switch outlet status with pre-configured delay time

Control	Description
on	Switch outlet on
off	Switch outlet off
reboot	Switch outlet off and then switch outlet on

The following table lists the available Switch Outlet Status commands:

Command	Outlet	Option	Control	Enter	Description
sw	oXX	imme delay	on	[Enter]	Switch outlet XX on with option imme or delay. XX: Outlet number (01–04)
sw	oXX	imme delay	off	[Enter]	Switch outlet XX off with option imme or delay. XX: Outlet number (01–04)
sw	oXX		reboot	[Enter]	Switch outlet XX off and on. XX: Outlet number (01–04)

Note: 1. Each command string can be separated with a space.

2. The **Option** command string can be skipped and **delay** will be used by default.

Read Environmental Value

The Read Environmental Value command allows you to view measurements from the eco PDU's environmental sensors.

The formula for Read Environmental Value commands is as follows:

Command + Outlet + Number + Option + [Enter]

1. For example, if you want to read environmental sensor 02 with a simple return string, type the following:

read sensor o02 simple [Enter]

2. For example, if you want to read environmental sensor 01 with a format return string, type the following:

read sensor o01 format [Enter]

The following tables show the possible values for the Read Environmental Value commands:

Command	Description
read sensor	Read environmental sensor value command.

Outlet	Description
o	Outlet with environmental sensor installed command
xx	PDU Outlet number with environmental sensor installed xx: Outlet on PDU (01–04) Example: o02

Option	Description
simple	Return simple string of the environmental sensor value on the selected power outlet with environmental sensor installed.
format	Return format string of the environmental sensor value on the selected power outlet with environmental sensor installed.

The following table lists the available Read Environmental Value commands:

Command	Sensor	Option	Enter	Description
read sensor	oXX	simple format	[Enter]	Read the environmental sensor value on the selected power outlet with environmental sensor installed. Outlet XX with option simple or format. XX: Outlet number (01–04).

Note: 1. Each command string can be separated with a space.

2. The **Option** command string can be skipped and **format** will be used by default.

Close Telnet Session

The Close Telnet Session command allows you to disconnect the telnet session from the eco PDU.

The formula for the Close Telnet Session command is as follows:

Command + [Enter]

1. For example, if you want to disconnect the telnet session, type the following:

quit [Enter]

The following table shows the value for the Close Telnet Session command:

Command	Description
quit	Close telnet session command

The following table lists the Close Telnet Session command:

Command	Enter	Description
quit	[Enter]	Disconnects telnet session with PG95 / PG96 / PG98 3-Phase 30-Outlet 0U PDU.

Reboot PDU Device

The Reboot PDU Device command allows you to reboot the eco PDU.

The formula for Reboot PDU Device commands is as follows:

Command + [Enter]

1. For example, if you want to reboot the eco PDU, type the following:

reboot [Enter]

The following tables show the possible values for the Read Environmental Value commands:

Command	Description
reboot	Reboot PDU device command

The following table lists the available Reboot PDU Device command:

Command	Enter	Description
reboot	[Enter]	Reboots the eco PDU.

Reset All PDU Config to Default Value

The Reset All PDU Config to Default command allows you to reset the eco PDU to the default factory settings.

The formula for Reset All PDU Config to Default Value commands is as follows:

Command + [Enter]

1. For example, if you want to reset the eco PDU, type the following:

clearallsetting [Enter]

The following tables show the possible values for the Reset All PDU Config to Default Value commands:

Command	Description
clearallsetting	Reset all PDU configuration to default value command

The following table lists the available Reset All PDU Config to Default Value command:

Command	Enter	Description
clearallsetting	[Enter]	Resets the eco PDU to default factory settings.

This Page Intentionally Left Blank

Safety Instructions

General

- ◆ This product is for indoor use only.
- ◆ Read all of these instructions. Save them for future reference.
- ◆ Follow all warnings and instructions marked on the device.
- ◆ Do not place the device on any unstable surface (cart, stand, table, etc.). If the device falls, serious damage will result.
- ◆ Do not use the device near water.
- ◆ Do not place the device near, or over, radiators or heat registers.
- ◆ The device cabinet is provided with slots and openings to allow for adequate ventilation. To ensure reliable operation, and to protect against overheating, these openings must never be blocked or covered.
- ◆ The device should never be placed on a soft surface (bed, sofa, rug, etc.) as this will block its ventilation openings. Likewise, the device should not be placed in a built in enclosure unless adequate ventilation has been provided.
- ◆ Never spill liquid of any kind on the device.
- ◆ Unplug the device from the wall outlet before cleaning. Do not use liquid or aerosol cleaners. Use a damp cloth for cleaning.
- ◆ The device should be operated from the type of power source indicated on the marking label. If you are not sure of the type of power available, consult your dealer or local power company.
- ◆ To prevent damage to your installation it is important that all devices are properly grounded.
- ◆ The device is equipped with a 3-wire grounding type plug. This is a safety feature. If you are unable to insert the plug into the outlet, contact your electrician to replace your obsolete outlet. Do not attempt to defeat the purpose of the grounding-type plug. Always follow your local/national wiring codes.
- ◆ The equipment should be installed near the wall socket outlet and the disconnect device (appliance coupler on detachable power supply cord or plug on non-detachable power supply cord) should be readily accessible.

- ◆ Do not allow anything to rest on the power cord or cables. Route the power cord and cables so that they cannot be stepped on or tripped over.
- ◆ To help protect your system from sudden, transient increases and decreases in electrical power, use a surge suppressor, line conditioner, or uninterruptible power supply (UPS).
- ◆ Position system cables and power cables carefully; Be sure that nothing rests on any cables.
- ◆ When connecting or disconnecting power to hot pluggable power supplies, observe the following guidelines:
 - ◆ Install the power supply before connecting the power cable to the power supply.
 - ◆ Unplug the power cable before removing the power supply.
 - ◆ If the system has multiple sources of power, disconnect power from the system by unplugging all power cables from the power supplies.
- ◆ Never push objects of any kind into or through cabinet slots. They may touch dangerous voltage points or short out parts resulting in a risk of fire or electrical shock.
- ◆ Do not attempt to service the device yourself. Refer all servicing to qualified service personnel.
- ◆ If the following conditions occur, unplug the device from the wall outlet and bring it to qualified service personnel for repair.
 - ◆ The power cord or plug has become damaged or frayed.
 - ◆ Liquid has been spilled into the device.
 - ◆ The device has been exposed to rain or water.
 - ◆ The device has been dropped, or the cabinet has been damaged.
 - ◆ The device exhibits a distinct change in performance, indicating a need for service.
 - ◆ The device does not operate normally when the operating instructions are followed.
- ◆ Only adjust those controls that are covered in the operating instructions. Improper adjustment of other controls may result in damage that will require extensive work by a qualified technician to repair.
- ◆ Do not connect the RJ-11 connector marked “Sensor” to a public telecommunication network.

Rack Mounting

- ◆ Before working on the rack, make sure that the stabilizers are secured to the rack, extended to the floor, and that the full weight of the rack rests on the floor. Install front and side stabilizers on a single rack or front stabilizers for joined multiple racks before working on the rack.
- ◆ Always load the rack from the bottom up, and load the heaviest item in the rack first.
- ◆ Make sure that the rack is level and stable before extending a device from the rack.
- ◆ Use caution when pressing the device rail release latches and sliding a device into or out of a rack; the slide rails can pinch your fingers.
- ◆ After a device is inserted into the rack, carefully extend the rail into a locking position, and then slide the device into the rack.
- ◆ Do not overload the AC supply branch circuit that provides power to the rack. The total rack load should not exceed 80 percent of the branch circuit rating.
- ◆ Make sure that all equipment used on the rack – including power strips and other electrical connectors – is properly grounded.
- ◆ Ensure that proper airflow is provided to devices in the rack.
- ◆ Ensure that the operating ambient temperature of the rack environment does not exceed the maximum ambient temperature specified for the equipment by the manufacturer
- ◆ Do not step on or stand on any device when servicing other devices in a rack.

The eco PDU's Main Power Cord

Use the power cord supplied with this package. If it becomes necessary to replace the cord supplied with this package, be sure to use a cord of at least the same standard as the one provided.



Securing the Power Cables

To secure the cables in the eco PDU's power outlets, use only the ATEN Lock-Your-Plug cable holders that have been specifically designed to work with the eco PDU. Using any other kind of cable securing device could be highly dangerous. Please contact your ATEN dealer for information about ATEN Lock-Your-Plugs.

Resetting the Circuit Breaker

Before switching the circuit breaker to reset a trip, power down and disconnect all devices connected to the eco PDU's power outlets to prevent damage caused by a sudden power surge. If a power surge causes the eco PDU's circuit breaker to switch off the power and it needs to be reset, follow the instructions below.

Recovery Procedure:

1. Safely power down and disconnect all devices connected to the eco PDU's power outlets.
2. Switch off the circuit breaker for the source that is providing power to the eco PDU.
3. Switch the eco PDU's circuit breaker to reset the trip.
4. Switch on the circuit breaker for the source that is providing power to the eco PDU.
5. Reconnect the devices to the eco PDU's power outlets, and power them on.

Technical Support

International

- ◆ For online technical support – including troubleshooting, documentation, and software updates: <http://eservice.aten.com>
- ◆ For telephone support, see *Telephone Support* on page 8.

North America

Email Support		support@aten-usa.com
Online Technical Support	Troubleshooting Documentation Software Updates	http://www.aten-usa.com/support
Telephone Support		1-888-999-ATEN ext 4988

When you contact us, please have the following information ready beforehand:

- ◆ Product model number, serial number, and date of purchase.
- ◆ Your computer configuration, including operating system, revision level, expansion cards, and software.
- ◆ Any error messages displayed at the time the error occurred.
- ◆ The sequence of operations that led up to the error.
- ◆ Any other information you feel may be of help.

IP Address Determination

If you are an administrator logging in for the first time, you need to access the eco PDU in order to give it an IP address that users can connect to. There are two methods to choose from. In each case, your client computer must be on the same network segment as the eco PDU. After you have connected and logged in, you can give the device a fixed network address. (See *Device Management*, page 61.)

Method 1:

For computers running Windows, an IP address can be determined and/or assigned with the IP Installer utility. The utility can be obtained from the *Download* area of our website or from the software CD. Look under *Driver/SW*, and the model of your device. After downloading the utility to your computer, do the following:

1. Unzip the contents of *IPInstaller.zip* to a directory on your hard drive.
2. Go to the directory that you unzipped the IPInstaller program to and run *IPInstaller.exe*. A dialog box similar to the one below appears:

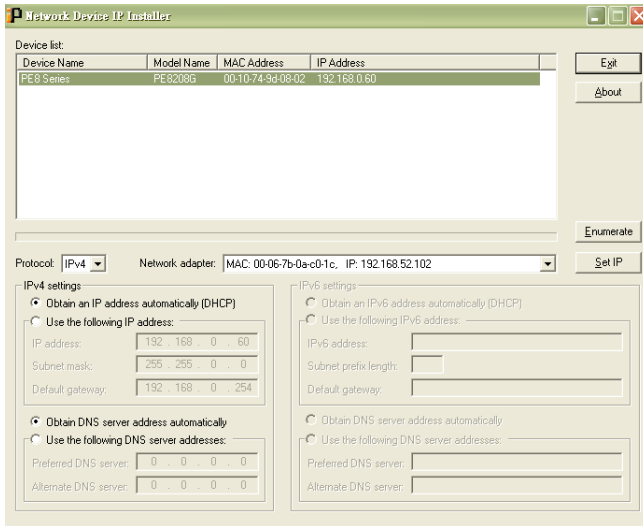

-
3. Select the device from the *Device List*.

Note: 1. If the list is empty, or your device doesn't appear, click **Enumerate** to refresh the Device List.

2. If there is more than one device in the list, use the MAC address to pick the one you want. The eco PDU's MAC address is located on its bottom panel.
-

4. Select either *Obtain an IP address automatically (DHCP)*, or *Specify an IP address*. If you chose the latter, fill the IP Address, Subnet Mask, and Gateway fields with the information appropriate to your network.
5. Click **Set IP**.
6. After the IP address shows up in the Device List, click **Exit** to end the program.

Method 2:

1. Set your computer's IP address to 192.168.0.XXX
Where XXX represents any number or numbers except 60 (192.168.0.60 is the default address of the eco PDU).
2. Specify the device's default IP address (192.168.0.60) in your browser to access it.
3. Assign a fixed IP address for the device (see *IPv4 Configuration*, page 63), that is suitable for the network segment that it resides on.
4. After you log out, reset your computer's IP address to its original value.
5. Once you have logged in, go to Network Settings to set up the permanent IP environment (see *IPv4 Configuration*, page 63).

Method 3:

ATEN eco DC allows you to determine/assign an IP address in order to configure a PDU device and monitor power status of the equipment connected to it. ATEN eco DC can be obtained from the Download area of the ATEN website.

Specifications

PG95230B / PG95230B2 / PG95230G

Function	PG95230B	PG95230B2	PG95230G
Electrical			
Nominal Input Voltage	208V 3PH (Delta)		400/230V 3PH (Star)
Maximum Input Current	20A (Max); 16A (UL de-rated)		16A (Max)
Input Frequency	50 - 60 Hz		
Input Connection	NEMA L21-20P	NEMA L15-20P	IEC 60309 16/20A Red 3P+N+PE
Input Power	7205VA (Max), 5764VA (UL de-rated)		11084VA (Max)
Outlet Type	(6) IEC 60320 C19, (24) IEC 60320 C13		
Nominal Output Voltage	208 Vac		230 Vac
Maximum Output Current (Outlet)	C13: 15A (Max), 12A (UL de-rated) C19: 20A (Max), 16A (UL de-rated)		C13:10A (Max), C19:16A (Max)
Breakers	N/A		
Metering	Bank level current, voltage, PF and KWh monitoring		
Outlet Switching	No		
Environment Sensor Ports	Yes		
Metering Accuracy	1%		
Physical Properties			
Dimensions (L x W x H)	179.00 x 5.60 x 6.80 cm (70.47 x 2.2 x 2.68 in.)		
Weight	7.34 kg (16.17 lb)		
Power Cord Length	3 m		
Environmental			

Temperature (Operating / Storage)	0 – 60 °C / -20 – 60 °C	
Humidity (Operating & Storage)	0 – 80% RH, non-condensing	
Compliance		
EMC Verification	FCC	CE, EMC
Safety Verification	UL, PSE	CE
Warranty	3 Years	

PG95330B / PG95330B2 / PG95330G

Function	PG95330B	PG95330B2	PG95330G
Electrical			
Nominal Input Voltage	208V 3PH (Delta)		400/230V 3PH (Star)
Maximum Input Current	30A (Max) 24A (UL de-rated)		32A (Max)
Input Frequency	50 - 60 Hz		
Input Connection	NEMA L21-30P	NEMA L15-30P	IEC 60309 32A Red 3P+N+E
Input Power	10808VA (Max), 8464VA (UL de-rated)		22170VA (Max)
Outlet Type	(6) IEC 60320 C19, (24) IEC 60320 C13		
Nominal Output Voltage	208 Vac		230 Vac
Maximum Output Current (Outlet)	C13: 15A (Max), 12A (UL de-rated) C19: 20A (Max), 16A (UL de-rated)		C13:10A (Max), C19:16A (Max)
Breakers	3 x UL489(2P)-20A		6 x UL489(1P)-16A
Metering	Bank level current, voltage, PF and kWh monitoring		

Outlet Switching	No	
Environment Sensor Ports	Yes	
Metering Accuracy	1%	
Physical Properties		
Dimensions (L x W x H)	179.00 x 5.60 x 6.80 cm (70.47 x 2.2 x 2.68 in.)	
Weight	8.41 kg (18.52 lb)	
Power Cord Length	3 m	
Environmental		
Temperature (Operating / Storage)	0 – 60 °C / -20 – 60 °C	
Humidity (Operating & Storage)	0 – 80% RH, non-condensing	
Compliance		
EMC Verification	FCC	CE, EMC
Safety Verification	UL, PSE	CE
Warranty	3 Years	

PG96230B / PG96230B2 / PG96230G

Function	PG96230B	PG96230B2	PG96230G
Electrical			
Nominal Input Voltage	208V 3PH (Delta)		400/230V 3PH (Star)
Maximum Input Current	20A (Max) ; 16A (UL de-rated)		16A (Max)
Input Frequency	50 - 60 Hz		
Input Connection	NEMA L21-20P	NEMA L15-20P	IEC 60309 16/20A Red 3P+N+PE
Input Power	7205VA (Max), 5764VA (UL de-rated)		11084VA (Max)
Outlet Type	(6) IEC 60320 C19, (24) IEC 60320 C13		
Nominal Output Voltage	208 Vac		230 Vac
Maximum Output Current (Outlet)	C13: 15A (Max), 12A (UL de-rated) C19: 20A (Max), 16A (UL de-rated)		C13:10A (Max), C19:16A (Max)
Breakers	N/A		
Metering	Bank level current, voltage, PF and KWh monitoring		
Outlet Switching	Yes		
Environment Sensor Ports	Yes		
Metering Accuracy	1%		
Physical Properties			
Dimensions (L x W x H)	179.00 x 5.60 x 6.80 cm (70.47 x 2.2 x 2.68 in.)		
Weight	7.36 kg (16.21 lb)		
Power Cord Length	3 m		
Environmental			
Temperature (Operating / Storage)	0 – 60 °C / -20 – 60 °C		
Humidity (Operating & Storage)	0 – 80% RH, non-condensing		

Compliance		
EMC Verification	FCC	CE, EMC
Safety Verification	UL, PSE	CE
Warranty	3 Years	

PG96330B / PG96330B2 / PG96330G

Function	PG96330B	PG96330B2	PG96330G
Electrical			
Nominal Input Voltage	208V 3PH (Delta)		400/230V 3PH (Star)
Maximum Input Current	30A (Max); 24A (UL de-rated)		32A (Max)
Input Frequency	50 - 60 Hz		
Input Connection	NEMA L21-30P	NEMA L15-30P	IEC 60309 32A Red 3P+N+E
Input Power	10808VA (Max), 8464VA (UL de-rated)		22170VA (Max)
Outlet Type	(6) IEC 60320 C19, (24) IEC 60320 C13		
Nominal Output Voltage	208 Vac		230 Vac
Maximum Output Current (Outlet)	C13: 15A (Max), 12A (UL de-rated) C19: 20A (Max), 16A (UL de-rated)		C13:10A (Max), C19:16A (Max)
Breakers	3 x UL489(2P)-20A		6 x UL489(1P)-16A
Metering	Bank level current, voltage, PF and KWh monitoring		
Outlet Switching	Yes		
Environment Sensor Ports	Yes		
Metering Accuracy	1%		

Physical Properties		
Dimensions (L x W x H)	179.00 x 5.60 x 6.80 cm (70.47 x 2.2 x 2.68 in.)	
Weight	8.43 kg (18.57 lb)	
Power Cord Length	3 m	
Environmental		
Temperature (Operating / Storage)	0 – 60 °C / -20 – 60 °C	
Humidity (Operating & Storage)	0 – 80% RH, non-condensing	
Compliance		
EMC Verification	FCC	CE, EMC
Safety Verification	UL, PSE	CE
Warranty	3 Years	

PG98230B / PG98230B2 / PG98230G

Function	PG98230B	PG98230B2	PG98230G
Electrical			
Nominal Input Voltage	208V 3PH (Delta)		400/230V 3PH (Star)
Maximum Input Current	20A (Max); 16A (UL de-rated)		16A (Max)
Input Frequency	50 - 60 Hz		
Input Connection	NEMA L21-20P	NEMA L15-20P	IEC 60309 16/20A Red 3P+N+PE
Input Power	7205VA (Max), 5764VA (UL de-rated)		11084VA (Max)
Outlet Type	(6) IEC 60320 C19, (24) IEC 60320 C13		
Nominal Output Voltage	208 Vac		230 Vac
Maximum Output Current (Outlet)	C13: 15A (Max), 12A (UL de-rated) C19: 20A (Max), 16A (UL de-rated)		C13:10A (Max), C19:16A (Max)
Breakers	N/A		
Metering	Outlet level current, voltage, PF and KWh Monitoring		
Outlet Switching	Yes		
Environment Sensor Ports	Yes		
Metering Accuracy	1%		
Physical Properties			
Dimensions (L x W x H)	179.00 x 5.60 x 6.80 cm (70.47 x 2.2 x 2.68 in.)		
Weight	7.36 kg (16.21 lb)		
Power Cord Length	3 m		
Environmental			
Temperature (Operating / Storage)	0 – 60 °C / -20 – 60 °C		
Humidity (Operating & Storage)	0 – 80% RH, non-condensing		

Compliance		
EMC Verification	FCC	CE, EMC
Safety Verification	UL, PSE	CE
Warranty	3 Years	

PG98330B / PG98330B2 / PG98330G

Function	PG98330B	PG98330B2	PG98330G
Electrical			
Nominal Input Voltage	208V 3PH (Delta)		400/230V 3PH (Star)
Maximum Input Current	30A (Max); 24A (UL de-rated)		32A (Max)
Input Frequency	50 - 60 Hz		
Input Connection	NEMA L21-30P	NEMA L15-30P	IEC 60309 32A Red 3P+N+E
Input Power	10808VA (Max), 8464VA (UL de-rated)		22170VA (Max)
Outlet Type	(6) IEC 60320 C19, (24) IEC 60320 C13		
Nominal Output Voltage	208 Vac		230 Vac
Maximum Output Current (Outlet)	C13: 15A (Max), 12A (UL de-rated) C19: 20A (Max), 16A (UL de-rated)		C13:10A (Max), C19:16A (Max)
Breakers	3 x UL489(2P)-20A		6 x UL489(1P)-16A
Metering	Outlet level current, voltage, PF and kWh Monitoring		
Outlet Switching	Yes		
Environment Sensor Ports	Yes		

Metering Accuracy	1%	
Physical Properties		
Dimensions (L x W x H)	179.00 x 5.60 x 6.80 cm (70.47 x 2.2 x 2.68 in.)	
Weight	8.43 kg (18.57 lb)	
Power Cord Length	3 m	
Environmental		
Temperature (Operating / Storage)	0 – 60 °C / -20 – 60 °C	
Humidity (Operating & Storage)	0 – 80% RH, non-condensing	
Compliance		
EMC Verification	FCC	CE, EMC
Safety Verification	UL, PSE	CE
Warranty	3 Years	

Administrator Login Failure

If you are unable to perform an administrator login (because the username and password information has become corrupted, or you have forgotten it, for example), you can clear the login information with the following procedure:

1. Power off the eco PDU and remove its Ethernet module.
2. Short the jumper labeled J3.

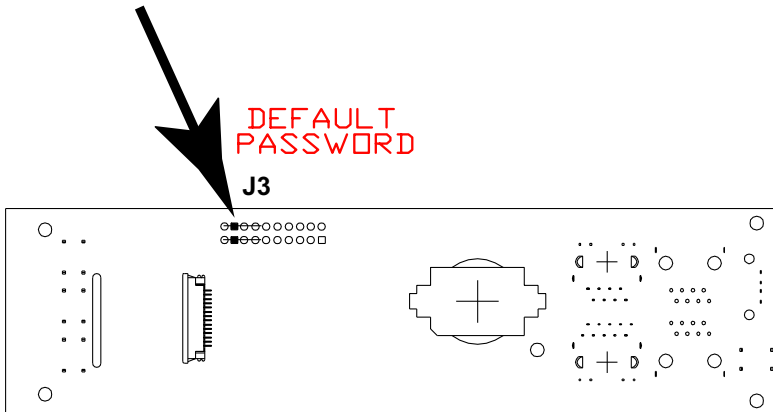

3. Power on the eco PDU.
4. Wait for the ATEN logo to disappear from the LCD display, this indicates the eco PDU is powered on, and then power off the eco PDU.
5. Remove the jumper cap from J3.
6. Close the Ethernet module and start the eco PDU.
After you start, you can use the default username and password to log in.

ATEN Standard Warranty Policy

Limited Hardware Warranty

ATEN warrants its hardware in the country of purchase against flaws in materials and workmanship for a Warranty Period of two [2] years (warranty period may vary in certain regions/countries) commencing on the date of original purchase. This warranty period includes the [LCD panel of ATEN LCD KVM switches](#). For UPS products, the device warranty is two [2] years but battery is one [1] year. Select products are warranted for an additional year (see [A+ Warranty](#) for further details). Cables and accessories are not covered by the Standard Warranty.

What is covered by the Limited Hardware Warranty

ATEN will provide a repair service, without charge, during the Warranty Period. If a product is defective, ATEN will, at its discretion, have the option to (1) repair said product with new or repaired components, or (2) replace the entire product with an identical product or with a similar product which fulfills the same function as the defective product. Replaced products assume the warranty of the original product for the remaining period or a period of 90 days, whichever is longer. When the products or components are replaced, the replacing articles shall become Customer property and the replaced articles shall become the property of ATEN.

To learn more about our warranty policies, please visit our website:

<http://www.aten.com/global/en/legal/policies/warranty-policy/>

Copyright © 2023 ATEN® International Co., Ltd.

Released: 2023-03-27

ATEN and the ATEN logo are registered trademarks of ATEN International Co., Ltd. All rights reserved. All other brand names and trademarks are the registered property of their respective owners.