







M5 Series Modular Matrix Switcher User Manual

Version1.8

The indications of symbols

■ Safety instructions

Some symbols pointing out the potential risk of injury and property loss are used in the instructions and devices, to help you use the devices safely and properly. Symbols and their indications are as follows. Please make sure that you have known these instructions before reading the manual.

	<p>Remind users to operate and maintenance according to the instructions attached to the devices. If ignoring this information, it may cause death or injury due to wrong operations.</p>
	<p>Remind users that uninsulated dangerous voltage in devices may lead to electric shock.</p>
	<p>CE certification means that the product has reached the safety requirements specified by EU regulations, users can be assured.</p>
	<p>SGS certification means that the product has reached the quality standards of the world's largest Societe Generale de Surveillance.</p>
	<p>This product has passed ISO9001 international quality certification (certification bodies: Rheinland TUV).</p>
	<p>WARNING: To avoid electric shock, do not open the cover, and do not place unnecessary portion in the chassis. Please contact qualified service personnel.</p>

■ General information indications

	<p>Information that may lead to an unsuccessful operation or setting and other relevant information needed to be noticed is listed.</p>
---	---

Important notes



Warning

To ensure reliable use of devices and safety of personnel, please observe the following items in the installation, use and maintenance.

Notes in installation

- ◆ Do not use this product in the following places: Where exists dust, smoke, conductive dust, corrosive gases or flammable gases; where exposes to high temperature, condensation or wind and rain; where exists vibration and shock. Electric shock, fire, incorrect operation will also lead to product damage and deterioration;
- ◆ During screw hole processing and wiring, metal chips and wire heads shall not be dropped into ventilation holes of controllers, which may cause a fire, malfunction or incorrect operation;
- ◆ When the installation work is done, make sure that no foreign body is left on the surface of ventilation, including contact paper and other packaging materials, otherwise it may lead to poor run-time heat, causing a fire, malfunction or incorrect operation;
- ◆ Avoid wiring or inserting/pulling plugs in charged state, otherwise it may easily lead to electric shock or cause damage to the circuit;
- ◆ Installation and wiring must be solid and reliable, poor contact may result in incorrect operation;
- ◆ For application in occasions with severe interference, shielded cables should be used to input and output high-frequency signal so that anti-interference performance of the system could be improved.

Notes in wiring

- ◆ All of the external power supply must be cut off before carrying out installation, wiring and other operations, or it may cause electric shock or equipment damage;
- ◆ This product is grounded through the grounding conductor of the power cord. In order to avoid electric shock, the grounding conductor must be connected to earth. Before connecting the input or output terminals of the product, make sure that the product is properly grounded;
- ◆ Once wiring is completed, foreign matters should be immediately removed. Please cover the terminal covers of product before power connection to avoid electric shock;

Notes in operation and maintenance

- ◆ Do not touch the terminal when power is on, or it may cause electric shock or incorrect operation;
- ◆ Perform cleaning and terminal tightening when power is off, for these operations may cause electric shock when power is on;
- ◆ Perform connection, removal or other operations of the communication signal cables and the cables of expansion board or control unit after power is off, or it may cause equipment damage or incorrect operation;
- ◆ Do not disassemble the equipment, so as not to damage the internal electrical components;
- ◆ Always read the manual, after security fully recognized, changing the program, commissioning, starting and stopping operations after security is fully recognized;
- ◆ Button batteries must be replaced when the power is off. When you indeed need to replace the button batteries with the power on, the operation should be performed by a qualified electrical

technician wearing insulated gloves.

Notes in product obsolescence

- ◆ Explosive electrolytic capacitors: It may cause explosion when electrolytic capacitor on the circuit board burns;
- ◆ Please collect and process separately, it cannot be put in the life garbage.
- ◆ Please process it as industrial waste, or process it in accordance with local environmental regulations.

Contents

Chapter One Overview	1
1.1 Product Equipment	1
1.2 function features	2
1.3 cabinet installation	2
Chapter Two Hardware Introductions	3
2.1 VW-VL0808 panel diagram	3
2.2 VW-VL1616 panel diagram	3
2.3 VW-VL3636 panel diagram	3
2.4 VW-VL7272 panel diagram	6
2.5 Link of matrix and peripherals	8
2.5.1 Input interface description	8
2.5.2 Output interface description	8
2.5.3 Control board communication port and link method	8
2.5.4 Matrix RS-232 control interface	8
2.5.5 Link of matrix and control computer	8
2.5.6 Matrix KEYBOARD interface	8
2.5.7 Link of matrix and extended keyboard	9
2.5.8 Matrix Ethernet Interface	9
2.5.8.1 Hardware linking method	9
2.5.8.2 Connection Method Description of RJ45 Ethernet Port straight-through Line and Cross-line	9
2.5.9 HDMI port description	10
2.5.10 DVI port description	10
2.5.11 DB15 interface description	11
2.5.12 DB15 male socket transfer cable(S terminal, RCA head)	11
2.5.13 DB15 male socket transfer cable definition	12
Chapter Three Control Panel Operating Instructions	13
3.1 panel description	13
3.1.1 VW-VL0808 panel	14
3.1.2 VW-VL1616 panel	14
3.1.3 VW-VL3636 panel	15
3.2 input boards	18
3.2.1 MX-HM4I input board function features	18
3.2.2 MX-DVI4I input board function features	18
3.2.3 MX-HD4I twisted pair input board function features	18
3.2.4 MX-VA4I input board function features	18
3.2.5 MX-SDI4I input board function features	19
3.2.6 MX-SF4I optical fiber input board function features	19
3.2.7 MX-IP2I input card Functions and Features	19
3.2.8 MX-HM2I 4K HDMI input board function features	19
3.3 output boards	19
3.3.1 MX-HM4O seamless output board function features	19

3.3.2 MX-DVI4O seamless output board function features	19
3.3.3 MX-HD4O twisted pair seamless output board function features	20
3.3.4 MX-VA4O seamless output board function features	20
3.3.5 MX-SDI4O seamless output board function features	20
3.3.6 MX-SF4O optical fiber seamless output board function features	20
3.3.7 MX-HM2O 4K HDMI OUT seamless output board function features	20
3.4 preview boards	21
3.4.1 MX-PMX preview board function features	21
3.5 control boards	21
3.5.1 VIS-CON ENT4 control board function features	21
3.5.2 VIS-CON ENT5 advanced control board function features	21
3.6 specifications and technical parameters	22
Chapter Four Instructions	29
4.1 M5 series Matrix Switcher instructions	29
4.2 Splicer instructions	38
Chapter Five Software	39
5.1 Connection	39
5.2 Matrix switching control(Seamless output card is needed)	41
Chapter Six Web Control Based on VIS-CON ENT4	41
6.1 Connection	41

Chapter One Overview

M5 series Modular matrix switcher can realize graphics processing and seamless switching flexibly. The matrix adopts high-performance hardware design, perfectly supports a variety of high-definition digital / analog signal switching and processing, and supports two-way RS-232, two-way IR signal assigned switching function. It can also divide a completed image signal into several signals assigned to several different display unites, forming a large display screen to display dynamic images. It provides a one-stop solution for various industries to assign, switch and process a variety of video and control signals, which can be widely used in radio and television engineering, multimedia conference room, large-screen display engineering, television teaching, intelligent traffic management centers, command and control centers and other places.

X series Modular matrix switcher contains VW-VL0808, VW-VL1616, VW-VL3636, VW-VL7272 and other models, its signal input/output interface contains HDMI, DVI, VGA, HDBaseT, SDI, optical fiber and other video interfaces. Leading all-digital signal processing technology ensures undistorted processing, sending top quality screen to the display terminal. With customized configuration of various types of the same or different input/output boards, single interface type or multi-interface type of matrix can be formed, such as optical fiber matrix, HDMI matrix, DVI matrix, CAT5 matrix, VGA matrix, YUV matrix, Video matrix and so on.

X series Modular matrix switcher provides a variety of control modes, with remote control operation, RS-485 extended keyboard, but also provides two standard RS-232 communication interfaces and network ports, convenient for users to coordinate it with various remote control devices.

1.1 Product Equipment

VW-VL0808

VW-VL1616

VW-VL3636

VW-VL7272

Modular matrix switcher can be composed of any of the following input and output boards:

Input boards:

- ◆ MX-HM4I input board (HDMI signal input)
- ◆ MX-DV4I input board (DVI signal input)
- ◆ MX-HD4I twisted pair input board (HDBaseT signal input)
- ◆ MX-VA4I input board (CV, YPbPr, VGAI signal input)
- ◆ MX-SDI4I input board (SDI signal input)
- ◆ MX-SF4I optical fiber input board (OPTICAL FIBER signal input)

Seamless output boards:

- ◆ MX-HM4O seamless output board (HDMI signal output)
- ◆ MX-DVI4O seamless output board (DVI, RGB signal output)
- ◆ MX-HD4O twisted pair seamless output board (HDBaseT signal output)
- ◆ MX-VA4O seamless output board (CV, YPbPr, VGAI signal output)
- ◆ MX-SDI4O seamless output board (SDI signal output)
- ◆ MX-SF4O optical fiber seamless output board (OPTICAL FIBER signal output)

Preview board:

- ◆ MX-PMX preview board (video signal output)

Control board:

- ◆ VIS-CON ENT4 control board

- ◆ VIS-CON ENT5 advanced control board

1.2 function features

- ◆ All digital switching, each seamless output board can realize real-time seamless switching;
- ◆ Each stitching output board can realize video stitching; picture windows in full screen can zoom, overlay and roam arbitrarily;
- ◆ Preview board can realize previewing videos by group and switching function;
- ◆ Support DVI 1.0 protocol, in line with HDCP1.3, compatible with HDMI 1.3a;
- ◆ Support hot plug, support audio and video signal switching together;
- ◆ Digital audio and analog audio in HDMI input board can be input selectively, digital audio and analog audio in HDMI output board can be output simultaneously;
- ◆ Support PC software control switching and EDID management;
- ◆ HDBaseT input/output signals support embedded (or local) two-way RS-232 and two-way IR signals, and can switch optionally with video signal or switch separately. They also support POC providing external power supply (VW-VL3636 and its upgrades support POC);
- ◆ Flexible control with infrared remote control, RS485, RS232 communication interface and network ports, and can be controlled by distant HDBaseT / optical fiber serial ports, convenient for users to coordinate it with various remote control devices;
- ◆ Support firmware upgrade online;
- ◆ support intelligent control matrix fan operation;

- ◆ SDI input board has looping out function;
- ◆ VW-VL3636 and its upgrades have redundant power supply design;
- ◆ Plug-in board structure design, flexibly allocate input/output signal type and signal channel number.

1.3 cabinet installation

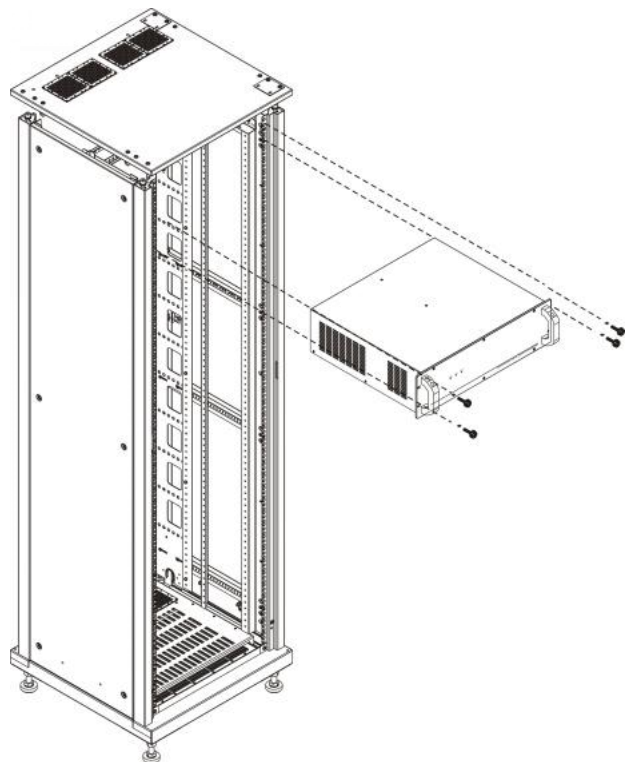

Chapter Two Hardware Introductions

2.1 VW-VL0808 panel diagram

VW-VL0808 front panel:

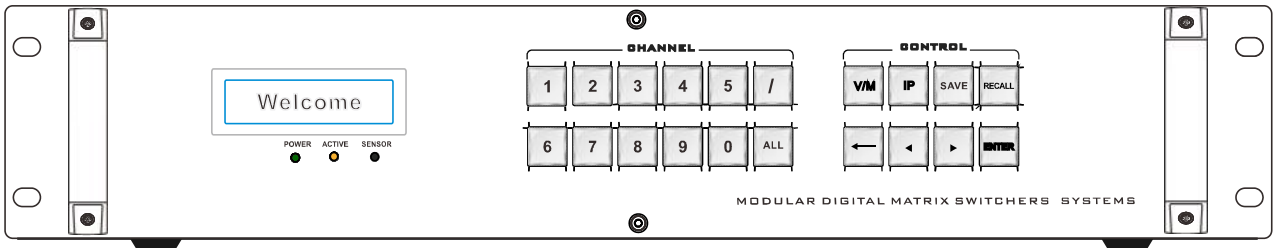

VW-VL0808 back panel:

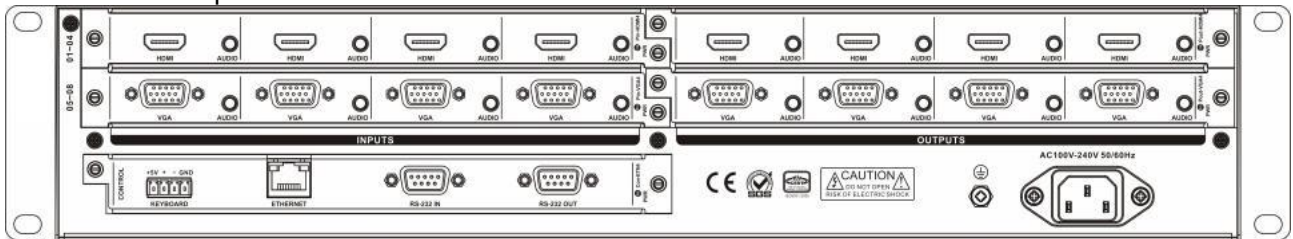

2.2 VW-VL1616 panel diagram

VW-VL1616 front panel:

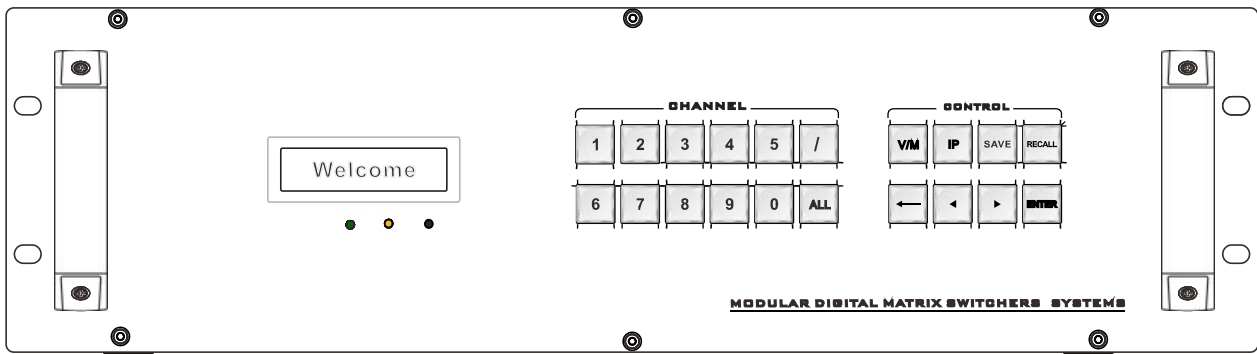

VW-VL1616 back panel:

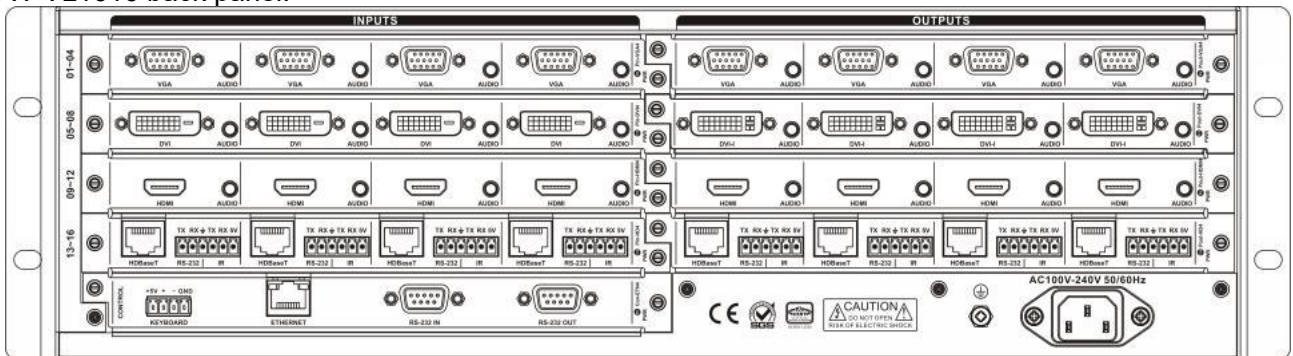

2.3 VW-VL3636 panel diagram

VW-VL3636 front panel:

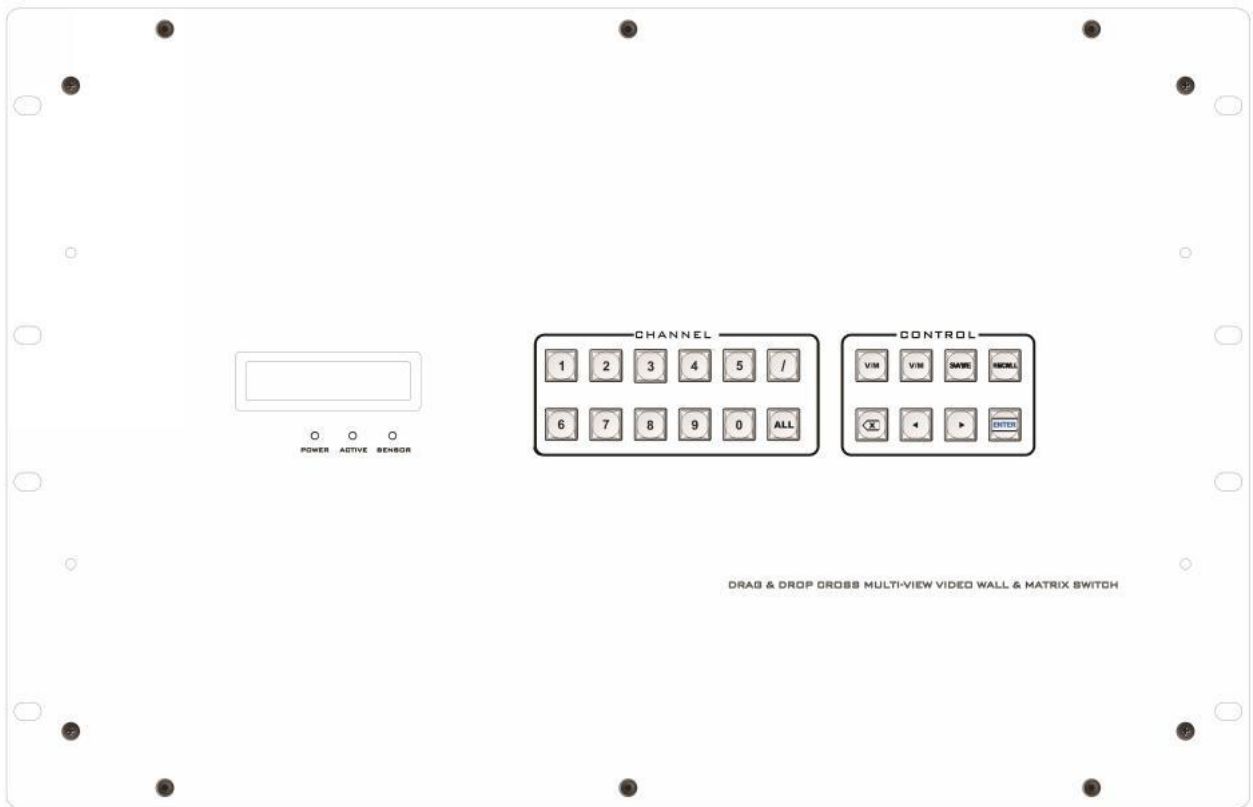

VW-VL3636 back panel:

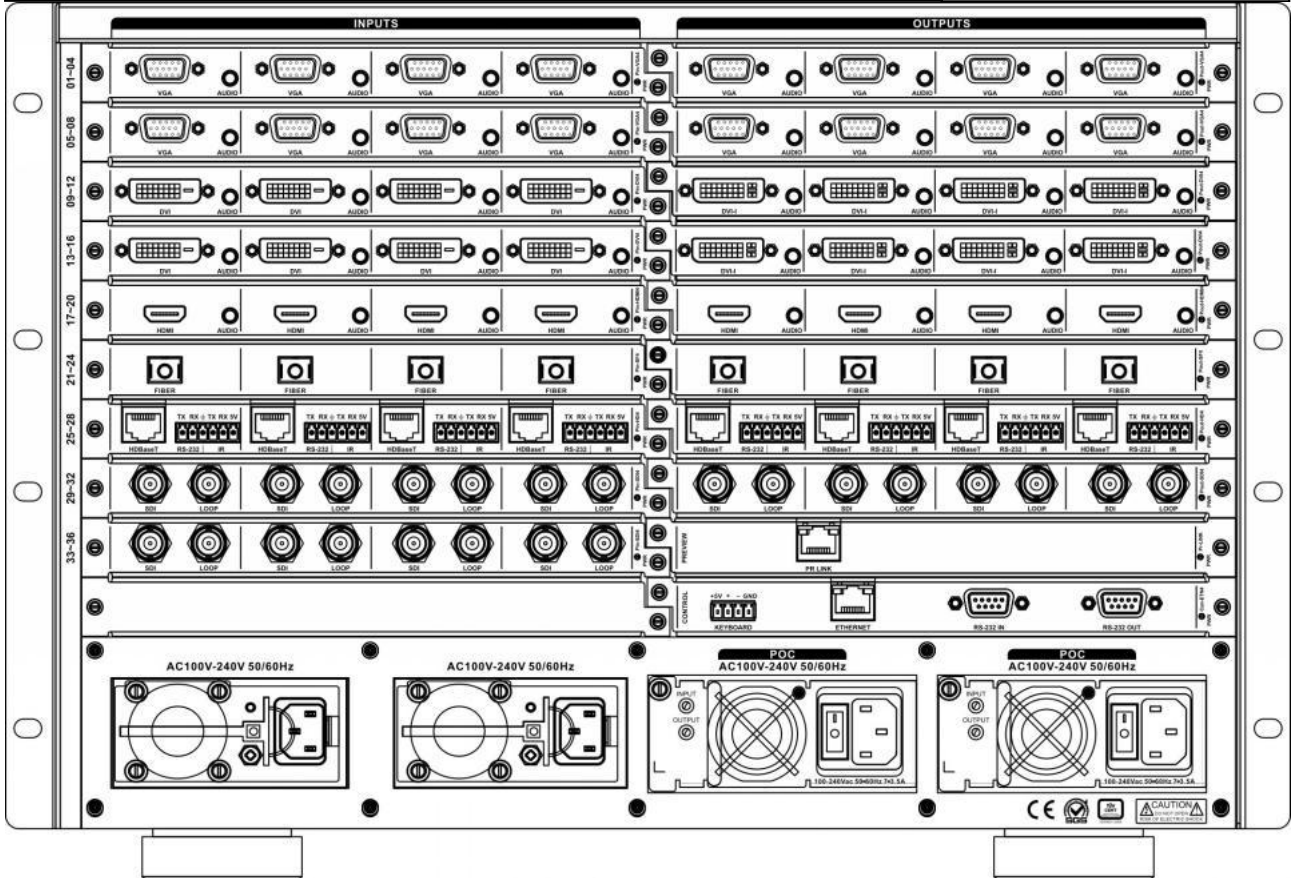

2.4 VW-VL7272 panel diagram

VW-VL7272 front panel

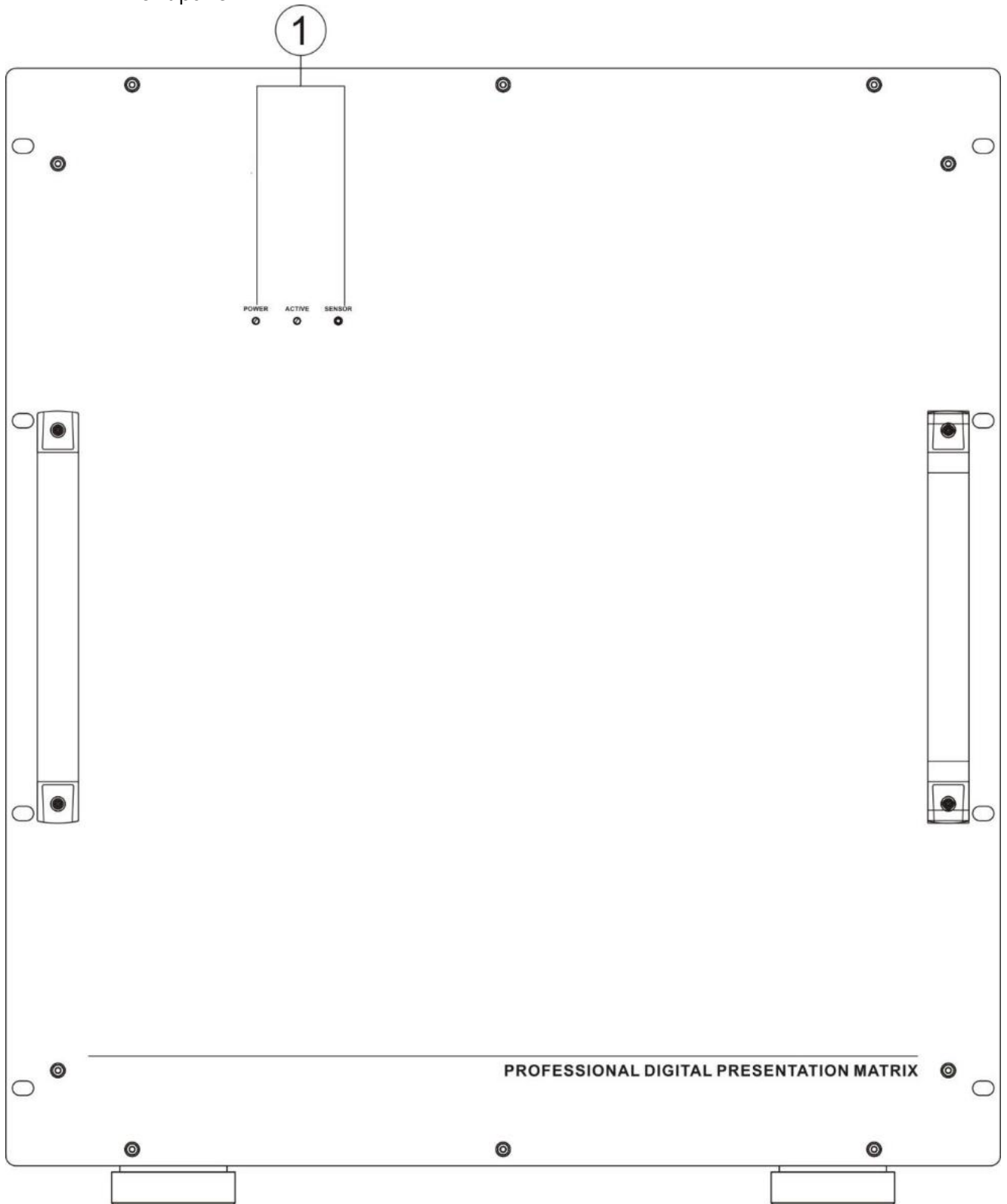

VW-VL7272 Rear Panel :

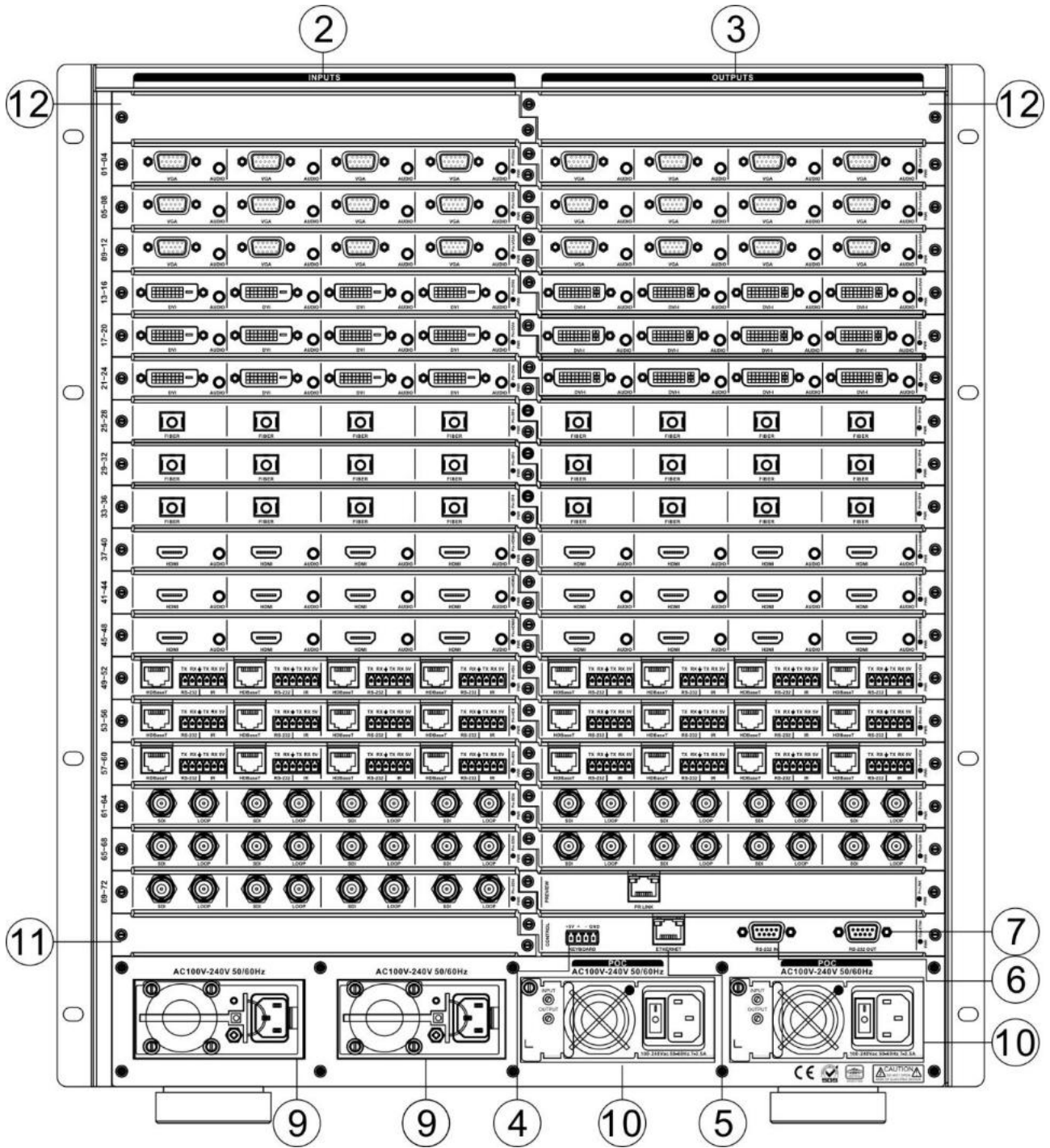

2.5 Link of matrix and peripherals

2.5.1 Input interface description

The input interface is composed of MX-DV4 I, MX-HM4I, MX-HD4I, MX-VA4I, MX-SDI4I and MX-SF4I input board, enable to combine various input signal formats arbitrarily.

2.5.2 Output interface description

The output interface is composed of MX-DV I4O, MX-HM4O, MX-HD4O, MX-VA4O, MX-SD I4O, MX-SF4O seamless output board enable to combine various input signal formats arbitrarily.

2.5.3 Control board communication port and link method

M5 modular matrix provides standard RS-232 serial communication ports, in addition to realize switching operations with infrared remote control, it can also control by using a variety of control systems (such as PC, VISSONIC control systems, control systems of other manufacturers, etc.).

2.5.4 Matrix RS-232 control interface

Modular matrix provides two-way RS-232 serial interfaces (a DB9 female connector, a male DB9 connector), you can use this interface to control the matrix. Pin description of RS-232 port DB9 female connector is as follows:

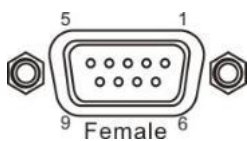

pin	signal	description
1	-	-
2	TXD	RS-232 protocol, sending data
3	RXD	RS-232 protocol, receiving data
4	-	-
5	GND	Signal ground
6	-	-

7	-	-
8	-	-
9	-	-

Pin description of RS-232 port DB9 male connector is as follows:

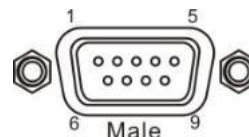

pin	signal	description
1	-	-
2	RXD	RS-232 protocol, sending data
3	TXD	RS-232 protocol, receiving data
4	-	-
5	GND	Signal ground
6	-	-
7	-	-
8	-	-
9	-	-

2.5.5 Link of matrix and control computer

With RS232 cable to link the computer's serial communication port (COM1 or COM2) and the matrix cabinet's RS-232 communication port, and use control command to control. For more details, refer to *Chapter five, Instructions*.

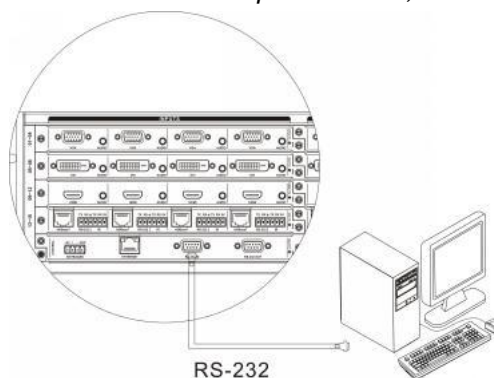

2.5.6 Matrix KEYBOARD interface

The matrix provides one-way KEYBOARD interface, it is used to link with extended keyboard

VIS-MKB100 so that you can switch the channels of the matrix. KEYBOARD is a four-foot 3.8mm phoenix interface, its pin description is as follows:

pin	signal	description
1	+5V	Output DC5V/1A, enable to provide power for MKB100
2	+	RS-485 protocol, DATA+
3	-	RS-485 protocol, DATA-
4	GND	Signal ground

2.5.7 Link of matrix and extended keyboard

Based on screen printing, correspondingly connect matrix cabinet KEYBOARD interface with extended keyboard MATRIX interface, then you can control the matrix. For more details, refer to *User's Manual of VIS-MKB100 Matrix Keyboard*.

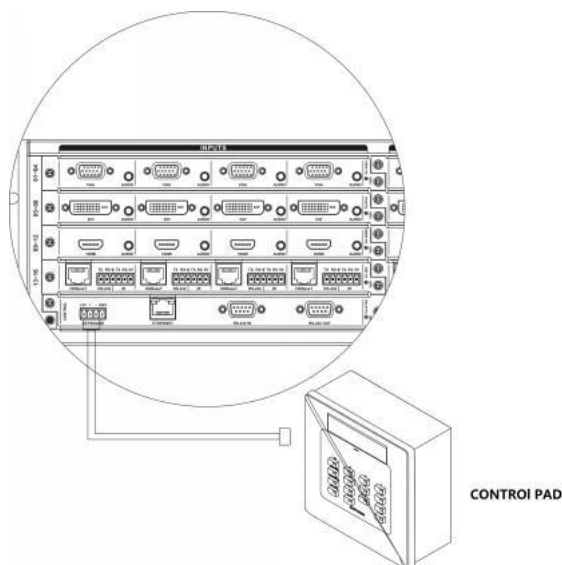

2.5.8 Matrix Ethernet Interface

2.5.8.1 Hardware linking method

There are two ways to link matrix with Ethernet adapter hardware

1) cross-connect method

Matrix and control computer is directly connected via CAT5 crossover cable.

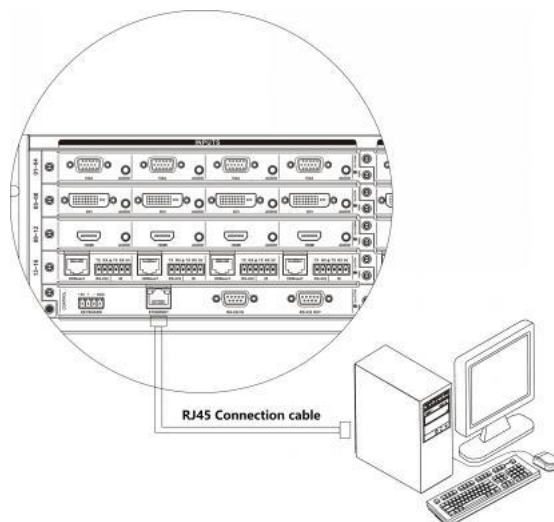

2) through-connect method

Matrix and Ethernet switchboard or concentrator is connected via CAT-5 straight-through cable.

2.5.8.2 Connection Method Description of RJ45 Ethernet Port straight-through Line and Cross-line

The system adopts CAT-5 (super 5-type line) as wires, using RJ-45 connector (commonly known as crystal head) of CAT-5 to connect network devices. Standard twisted-pair connection method is specifically regulated, aiming to ensure the symmetry of cable connector layout so that the interference between the cables within the connector can be offset. Super 5-type line in general has four pairs of wires twisted together, with different colors.

There are two ways to connect twisted pair: EIA / TIA 568B standard and EIA / TIA 568A standard.

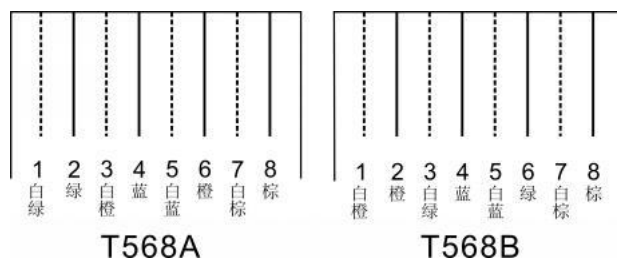

T568A line order							
1	2	3	4	5	6	7	8
White	Green	White	Blue	White	Orange	White	Brown
Green		Orange		Blue		Brown	

T568B line order							
1	2	3	4	5	6	7	8
White	Orange	White	Blue	White	Green	White	Brown
Orange		Green		Blue		Brown	

Straight-through line: both ends are connected in T568B line order.

Crossover line: one end is connected in T568A line order, the other end is connected in T568B line order.

2.5.9 HDMI port description

HDMI-A Type Line description:

Users can connect a variety of computer signals, audio and video signal equipment, such as DVD players, desktop computers, graphics workstations, and number displays in different occasions, output terminals can be connected to the projector, VCRs, computer monitors, amplifiers and so on.

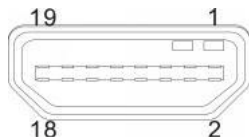

PIN	Function
1	TMDS Data2+
2	TMDS Data2 Shield
3	TMDS Data2-

4	TMDS Data1+
5	TMDS Data1 Shield
6	TMDS Data1-
7	TMDS Data0+
8	TMDS Data0 Shield
9	TMDS Data0-
10	TMDS Clock+
11	TMDS Clock Shield
12	TMDS Clock-
13	CEC
14	Reserved (in cable but N.C. on device)
15	SCL
16	SDA
17	DDC/CEC Ground
18	+5V Power
19	Hot Plug Detect

2.5.10 DVI port description

DVI-D Dual Link interface description

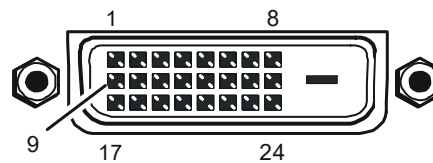

PIN	Function
1	T.M.D.S.Data2-
2	T.M.D.S.Data2+
3	T.M.D.S. Data 2/4 Shield
4	T.M.D.S. Data 4-
5	T.M.D.S. Data 4+
6	DDC Clock
7	DDC Data
8	No Connect
9	T.M.D.S.Data1-
10	T.M.D.S.Data1+
11	T.M.D.S.Data1/3 Shield
12	T.M.D.S.Data3-
13	T.M.D.S.Data3+
14	+5V Power
15	Ground (for +5V)
16	Hot Plug Detect
17	T.M.D.S. Data 0-
18	T.M.D.S. Data 0+

19	T.M.D.S. Data 0/5 Shield
20	T.M.D.S.Data5-
21	T.M.D.S.Data5+
22	T.M.D.S. Clock Shield
23	T.M.D. S. Clock +
24	T.M.D.S .Clock-

6	RGND	red ground
7	GGND	green ground
8	BGND	blue ground
9	KEY	reserved
10	SGND	digital ground
11	ID0	address code 0
12	SDA	data pin
13	HSYNC	horizontal synchronization
14	VSYNC	vertical synchronization
15	SCL	clock signal

2.5.11 DB15 interface description

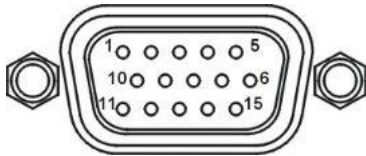

Pin description of component video DB15 port is as follows:

PI N	VGA	Componen t	S-Video	Composi te
1	RED	Pr	N/C	N/C
2	GREEN	Y	N/C	N/C
3	BLUE	Pb	N/C	N/C
4	ID2	N/C	N/C	CVBS
5	GND	GND	N/C	GND
6	GND	GND	GND	N/C
7	GND	GND	GND	N/C
8	GND	N/C	N/C	N/C
9	N/C	N/C	Y	N/C
10	GND	N/C	N/C	N/C
11	N/C	N/C	C	N/C
12	SDA	N/C	N/C	N/C
13	HSYNC	N/C	N/C	N/C
14	VSYNC	N/C	N/C	N/C
15	SCL	N/C	N/C	N/C

Pin description of VGA video output board is as follows:

pin	signal	description
1	RED	red primary
2	GREEN	green primary
3	BLUE	blue primary
4	ID2	address code 2
5	GND	ground

2.5.12 DB15 male socket transfer cable (S terminal, RCA head)



2.5.13 DB15 male socket transfer cable definition

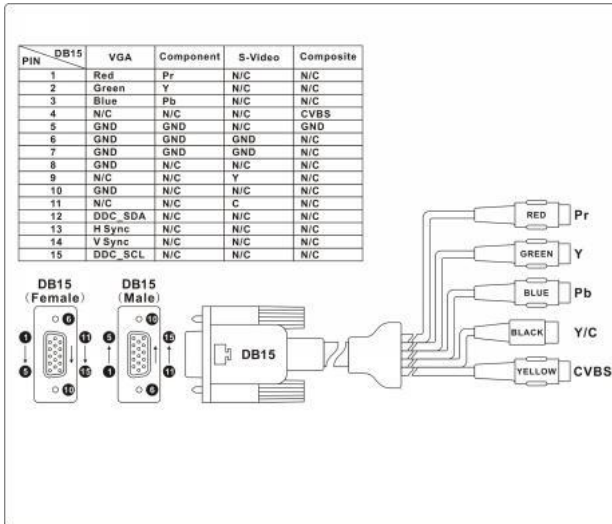

VGA input board of matrix supports the input of analog, composite video and component video; VGA output board supports the output of analog, composite video and component video. If users need input or output component video signal, they need connect DB15 male socket transfer cable (S terminal, RCA head). The two kinds of connection are different, two things should be noticed:

1. the connection of VGA input board: support VGA, CVBS and YPbPr signal; when CVBS and YPbPr signal are needed, only three lines of DB15 male socket transfer cable terminal is useful. As shown above, the connection of YPbPr signal is Y attached to green line, Pb attached to blue line, Pr attached to red line; For CVBS signal, green line is the right one, signals can be recognized automatically, no setting is needed (VGA input port can access three signals, but one port can only attach to one signal a time).

2. the connection of VGA output board: support VGA, CVBS and YPbPr signal; when CVBS and YPbPr signal are needed, four lines of DB15 male socket transfer cable terminal are useful. As shown above, the connection of YPbPr signal is Y attached to green line, Pb attached to blue line, Pr attached to red line; For CVBS signal, only yellow line is the right one. VGA or YPbPr signal output requires instruction setting; CVBS output has always been on, no setting is needed.

Chapter Three Control Panel Operating Instructions

3.1 panel description

Front Panel Operation

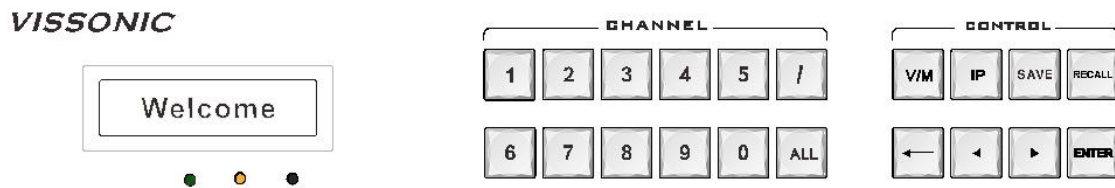

Seamless switching operation (need seamless output card VW-HM4O; VW-DV4O; VW-HD4O; VW-VA4O; VW-SF4O or VW-SD4O)

1.

Sample 1. Switch input 1 to the output 2

Sequencing Pressing button	LCD display	Note
1	1	Select the input 1
V/M	1V	press 1 times and display "V" for matrix switching action
2	1V2	Select output 2
ENTER	Switch OK!	Confirm. If there are no input board, the LCD display "Not online!"

Sample 2. Switch input 1 to the output 2 and output 3

Sequencing Pressing button	LCD display	Note
1	1	Select the input 1
V/M	1V	press 1 times and display "V" for matrix switching action
2	1V2	Select output 2
/	1V2/	Press "/" button
3	1V2/3	Select output 3
ENTER	Switch OK!	Confirm. If there are no input board, the LCD display "Not online!"

Sample 3. Switch the input 1 to all output

Sequencing Pressing button	LCD display	Note
1	1	Select the input 1
ALL	1All.	Switch finish.

3.1.1 VW-VL0808 panel

VW-VL0808 front panel:

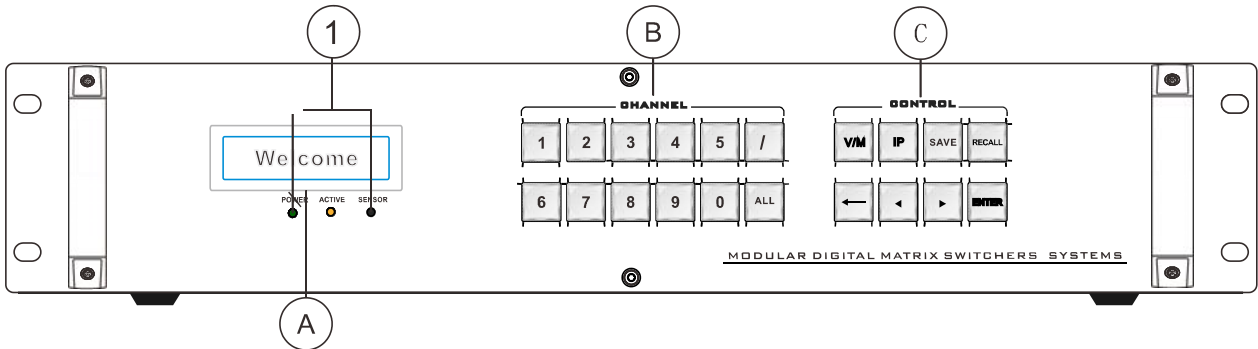

VW-VL0808 back panel:

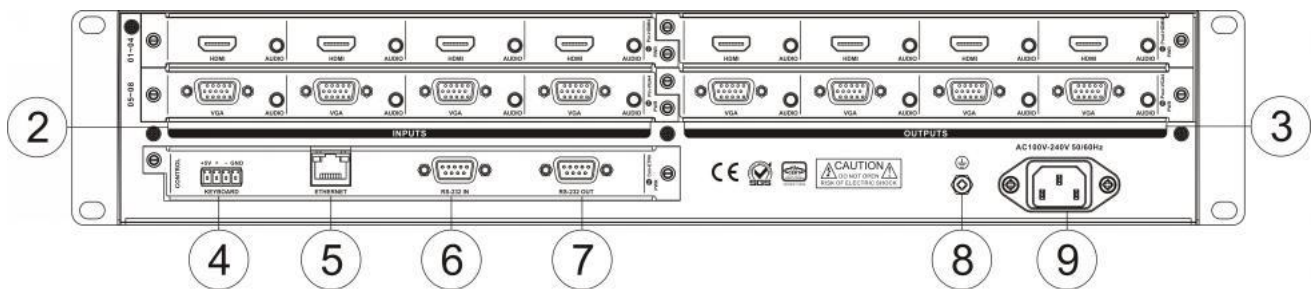

3.1.2 VW-VL1616 panel

VW-VL1616 front panel:

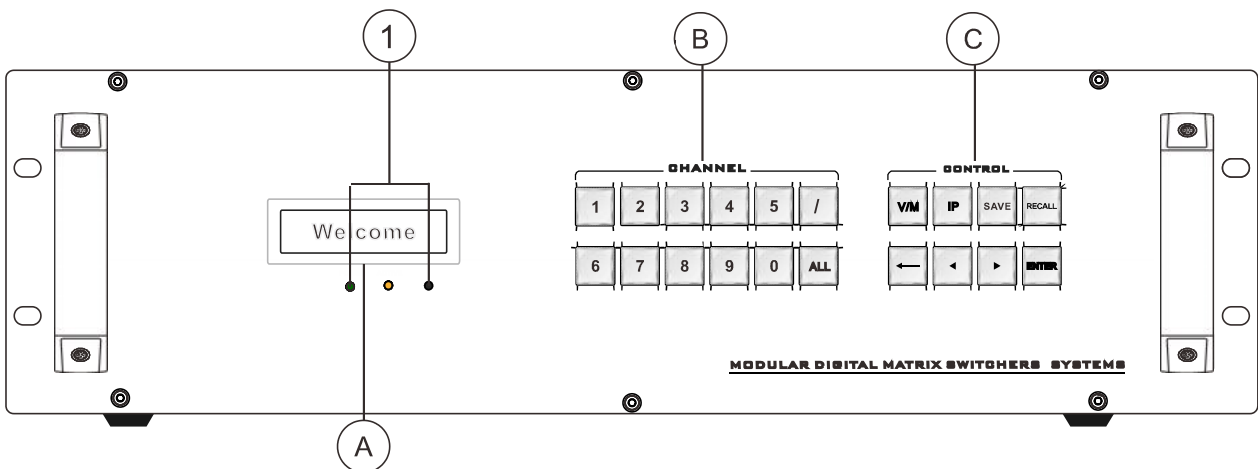

VW-VL1616 back panel:

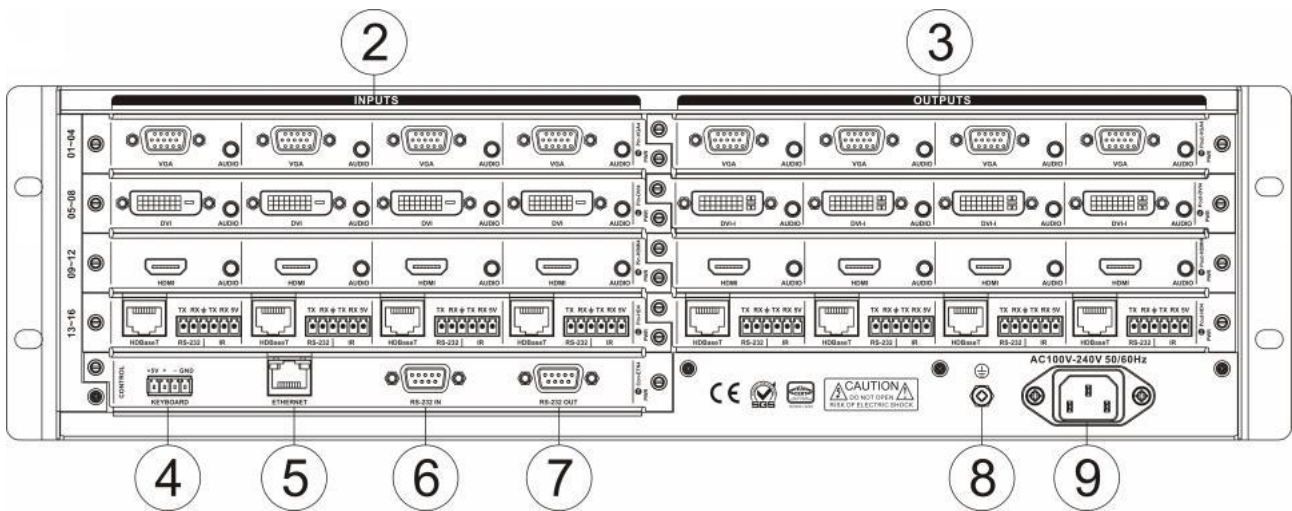

3.1.3 VW-VL3636 panel

VW-VL3636 front panel:

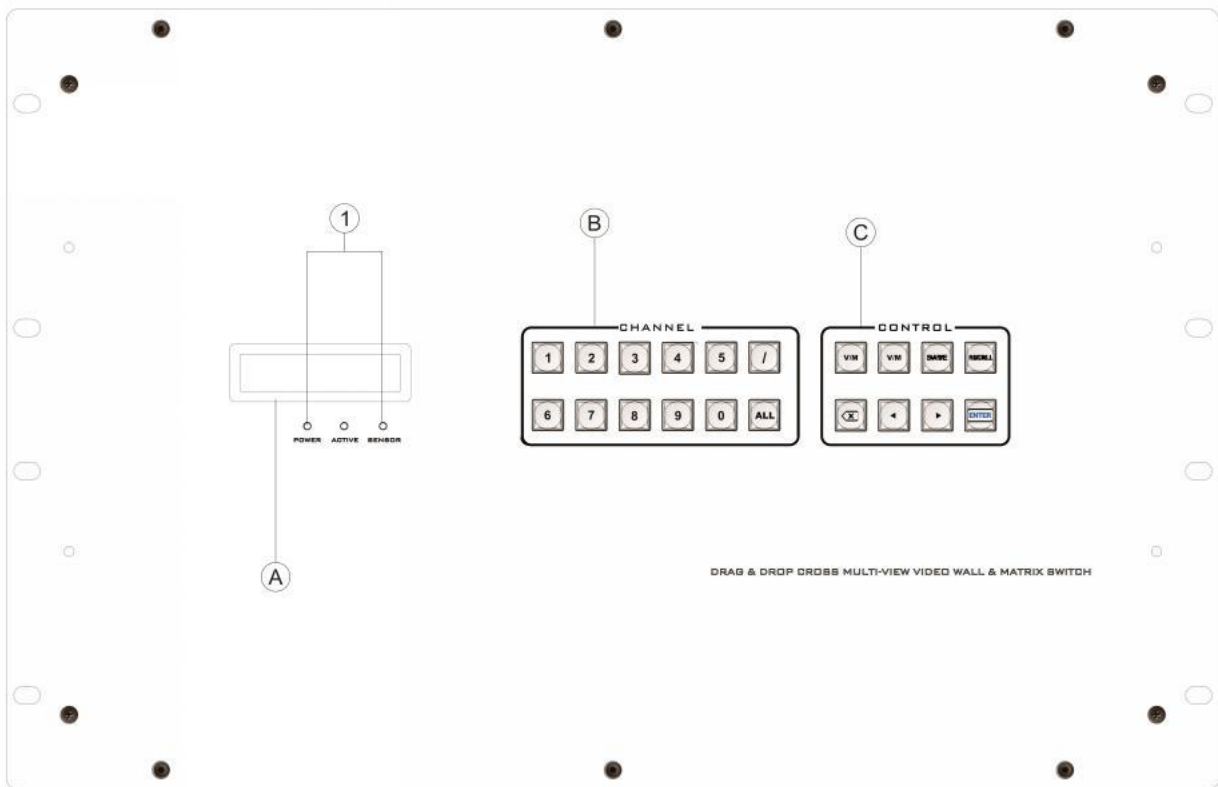

VW-VL3636 back panel:

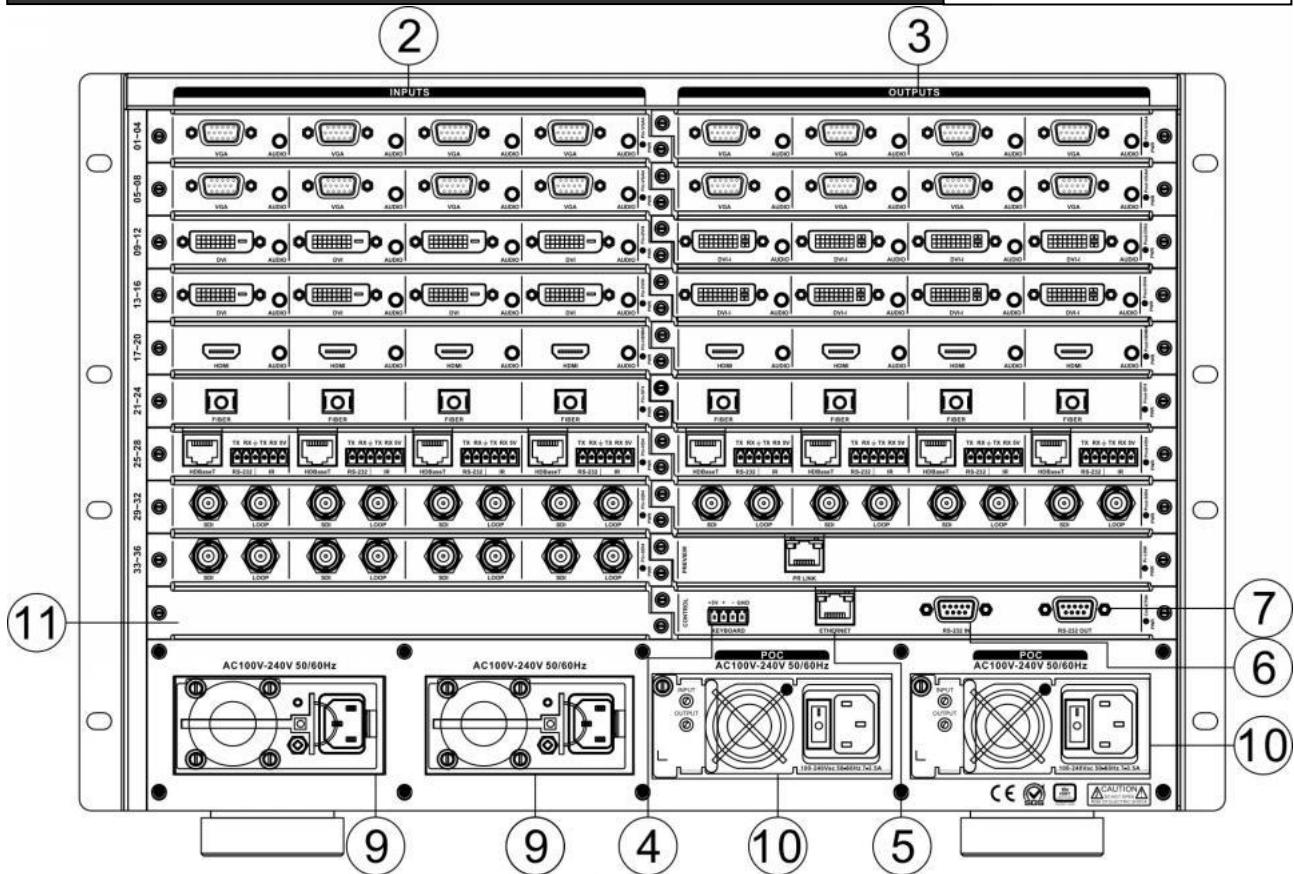

- ① **POWER:** power light
ACTIVE: state light of receiving commands
SENSOR: infrared receiving window
- ② **INPUTS**—**signal input terminal**
 Various boards are adopted as signals' input source, providing channel 8/16/36/72 input terminals to connect corresponding input devices.
- ③ **OUTPUTS**—**signal output terminal**
 Various boards are adopted as signals' output source, providing channel 8/16/36/72 output terminals to connect corresponding output devices.
- ④ **KEYBOARD**—**extended keyboard interface**
 Channel 1 KEYBOARD interface, used together with MCP100 keyboard.
- ⑤ **ETHERNET**—**RJ45 network interface**
 Ethernet link interface can be used to link local area network, internet and so on. Green light indicates the link is normal, sparkling orange light indicates it is receiving or sending data.
- ⑥ **RS-232 IN**—**RS-232 serial port input**
 Channel 1 independent RS-232 port (DB9 female socket) can be used to link PC or central control devices to control the system.
- ⑦ **RS-232 OUT**—**RS-232 serial port output**
 Channel 1 independent RS-232 port (DB9 male socket) can be used to link PC or central control devices to control the system.
- ⑧ **Earthing rod**
- ⑨ **Power interface**
 System power supports AC100~240V 50/60Hz input.
- ⑩ **POC power port**
 System POC offers power to external devices, and is only applicable to HD boards of

remote transmitters.

⑪ **Blank slot**

The lowest position of VW-VL3636 and VW-VL7272 matrix's input board slot is blank, video board cannot be used.









⑫ **Infrared serial port switching board slot**

It is used to access infrared serial port switching board. Accessing infrared R232 serial port extended switching port can transmit infrared signal or RS232 signal of HD, optical fiber and other input boards to output boards by setting instructions, and vice versa (output board -- input board). Only VW-VL7272 has this slot (infrared switching board is VW-VL7272's optional board)

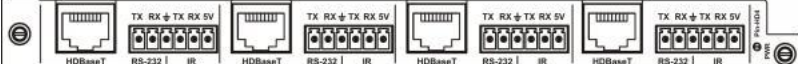
A. **LCD display**

B. **CHANNEL**——select the input/output channel to switch

C. **CONTROL**——input the commands to switch, call profile, set IP etc. operation.

name/model	Appearance
MX-HM4I HDMI seamless input board	
MX-DVI4I DVI seamless input board	
MX-HD4I HDB seamless input board	
MX-VA4I VGA seamless input board	
MX-SDI4I SDI seamless input board	
MX-SF4I optical fiber input board	
MX-HM4O HDMI seamless output board	
MX-DVI4O HDMI seamless output board	

MX-HD4O HDB seamless output board	
MX-VA4O VGA seamless output board	
MX-SDI4OSDI seamless output board	
MX-SF4O optical fiber seamless output board	
MX-PMX preview board	
VIS-CON ENT4 control board	
VIS-CON ENT5 control board	

3.2 input boards

3.2.1 MX-HM4I input board function features

- ◆ Four-way HDMI-A interface, 3.5 audio base;
- ◆ Maximum transmission distance can reach 35 meters;
- ◆ Support hot plugging, support seamless switch of audio and video together;
- ◆ Support analog audio, support HDMI embedded audio be input selectively;
- ◆ Support EDID reading function;
- ◆ Support HDMI1.3a, HDCP1.3 protocol, DVI1.0 protocol;
- ◆ Maximum supported resolution:
HDPC: 1920x1200P@60;
HDTV: 1920x1080P@60.

3.2.2 MX-DVI4I input board function features

- ◆ Four-way DVI-D interface, 3.5 audio base;
- ◆ Maximum transmission distance can reach 35 meters;
- ◆ Support hot plugging, support seamless switch of audio and video together;
- ◆ Support analog audio input;
- ◆ Support EDID reading function;
- ◆ Support HDMI1.3a, HDCP1.3 protocol,

DVI1.0 protocol;

- ◆ Maximum supported resolution:
HDPC: 1920x1200P@60;
HDTV: 1920x1080P@60.

3.2.3 MX-HD4I twisted pair input board function features

- ◆ Four-way high-speed RJ45 interface, four-way 6PIN phoenix interface;
- ◆ Maximum transmission distance via CAT5e/6 can reach 35 meters;
- ◆ Support hot plugging, support seamless switch of audio and video together;
- ◆ Support infrared serial input, combined with IO switch board, enable to realize infrared port switch;
- ◆ Support HDBaseT protocol;
- ◆ Support of providing power for external POC, matched with POC power, VW-VL3636 and its upgrades support this function;
- ◆ Maximum supported resolution:
HDPC: 1920x1200P@60;
HDTV: 1920x1080P@60.

3.2.4 MX-VA4I input board function features

- ◆ Four-way DB15 interface, 3.5 audio base;
- ◆ Support of inputting VGA, CVBS and YPbPr

signal, input signal source can be recognized automatically;

- ◆ Support hot plugging, support seamless switch of audio and video together;
- ◆ Support analog audio input;
- ◆ Maximum supported resolution:
HDPC: 1920x1200P@60;
HDTV: 1920x1080P@60.



Only when external video is input at VGA interface, VGA input board's 3.5mm audio port will receive audio signal.

3.2.5 MX-SDI4I input board function features

- ◆ Four-way BNC female interface, four-way BNC female interface looping out;
- ◆ Support hot plugging;
- ◆ Support HD/3G SDI signal.

3.2.6 MX-SF4I optical fiber input board function features

- ◆ Four-way single-core optical fiber input;
- ◆ Support hot plugging;
- ◆ Transmission distance with the aid of optical fiber transmitter can be 300 meters (multimode), and maximum transmission distance can reach 20 kilometers (signal-mode);
- ◆ Using IO switch board enables to realize infrared port switch;
- ◆ Maximum supported resolution:
HDPC: 1920x1200P@60;
HDTV: 1920x1080P@60.

3.2.7 MX-IP2I input card Functions and Features

- ◆ 2 channels high speed RJ45 interfaces;
- ◆ Maximal output distance with CAT5e/6 cable 100 M;
- ◆ Support web logging in to configure the network protocol, LAN parameters, and Remote Network parameters, etc.;

- ◆ HDTV: 1920x1080P@60.

Note: **The IP address of the connected IP camera and the interface's local IP address should be within the same network segment.**

3.2.8 MX-HM2I 4K HDMI input board function features

- ◆ Two-way HDMI-A interface, 2 channel 3.5 audio input and 2 channel 3.5 audio output;
- ◆ Maximum transmission distance can reach 35 meters by HDMI cable;
- ◆ Support hot plugging, support seamless switch of audio and video together;
- ◆ Support analog audio, support HDMI embedded audio be input selectively;
- ◆ Support EDID reading function;
- ◆ Support HDMI1.4a, HDCP1.3 protocol, DVI1.0 protocol;
- ◆ Maximum supported resolution:4Kx2K@30;

3.3 output boards

3.3.1 MX-HM4O seamless output board function features

- ◆ Four-way HDMI-A interface seamless output, 3.5 audio base;
- ◆ Maximum transmission distance can reach 15 meters;
- ◆ Support hot plugging, support seamless switch of audio and video together;
- ◆ Support analog audio and HDMI embedded audio be output together;
- ◆ Support EDID reading function;
- ◆ Support HDMI1.3a, HDCP1.3 protocol, DVI1.0 protocol;
- ◆ Maximum supported resolution:
HDPC: 1920x1200P@60;
HDTV: 1920x1080P@60.

3.3.2 MX-DVI4O seamless output board function features

- ◆ Four-way DVI-I interface seamless output,

3.5 audio base;

- ◆ Maximum transmission distance can reach 7 meters;
- ◆ Support hot plugging, support seamless switch of audio and video together;
- ◆ Support analog audio output;
- ◆ Support EDID reading function;
- ◆ Support DVI and VGA be output selectively;
- ◆ DVI output support DVI1.0 protocol;
- ◆ Maximum supported resolution:

HDPC: 1920x1200P@60;

HDTV: 1920x1080P@60.

3.3.3 MX-HD40 twisted pair seamless output board function features

- ◆ Four-way high-speed RJ45 interface seamless output, four-way 6PIN phoenix interface;
- ◆ Maximum transmission distance via CAT5e/6 can reach 100 meters;
- ◆ Support hot plugging, support seamless switch of audio and video together;
- ◆ Support infrared serial output, combined with IO switch board, enable to realize infrared port switch;
- ◆ Support HDBaseT protocol;
- ◆ Support of providing power for external POC, matched with POC power, VW-VL3636 and its upgrades support this function;
- ◆ Maximum supported resolution:
 - HDPC: 1920x1200P@60;
 - HDTV: 1920x1080P@60.

3.3.4 MX-VA40 seamless output board function features

- ◆ Four-way DB15 interface seamless output, 3.5 audio base;
- ◆ Support of outputting VGA, CVBS and YPbPr signal selectively;
- ◆ Support hot plugging, support seamless switch of audio and video together;
- ◆ Support analog audio output;
- ◆ Maximum supported resolution:
 - HDPC: 1920x1200P@60;

HDTV: 1920x1080P@60.

3.3.5 MX-SDI40 seamless output board function features

- ◆ Four-way BNC female interface seamless output, four-way BNC female interface looping out;
- ◆ Support hot plugging;
- ◆ Support HD/3G SDI signal.

3.3.6 MX-SF40 optical fiber seamless output board function features

- ◆ Four-way single-core optical fiber output;
- ◆ Support hot plugging;
- ◆ Transmission distance with the aid of optical fiber transmitter can be 300 meters (multimode), and maximum transmission distance can reach 20 kilometers (signal-mode);
- ◆ Using IO switch board enables to realize infrared port switch;
- ◆ Maximum supported resolution:
 - HDPC: 1920x1200P@60;
 - HDTV: 1920x1080P@60.

3.3.7 MX-HM20 4K HDMI seamless output board function features

- ◆ Two-way HDMI-A interface seamless output, 3.5 audio base;
- ◆ Maximum transmission distance can reach 15 meters;
- ◆ Support hot plugging, support seamless switch of audio and video together;
- ◆ Support analog audio and HDMI embedded audio be output together;
- ◆ Support EDID reading function;
- ◆ Support HDMI1.4a, HDCP1.3 protocol, DVI1.0 protocol;
- ◆ Maximum supported resolution:4Kx2K@30;

3.4 preview boards

3.4.1 MX-PMX preview board function features

- ◆ 1 channel RJ45 interface preview output for pre-loading max. 4 channels inputs on the software
 - ◆ Each pre-loading video resolution up to 1080P@30fps
 - ◆ Apply H.264 & JPEG multi-stream encoding, frame rate supports 1/16~60fps;
 - ◆ Support hot swap;
 - ◆ Support switching control from preview channel to output channel
 - ◆ Default IP:192.168.1.163 Port:5000.
- ◆ Support controlled programming.
 - ◆ Support advanced web-page visualization control card (needed to work with preview card MX-PMX)
 - ◆ Synchronous control of multiple terminals

3.5 control boards

3.5.1 VIS-CON ENT4 control board function features (Chassis standard configuration basic control card model)

- ◆ Two DB9 fully functional serial ports, enabling to control multiple peripherals, to receive commands and to forward data;
- ◆ One RJ45 interface can attach to PC software off board, enabling to control, query devices and so on;
- ◆ One 4P phoenix-head keyboard interface can attach to keyboards off board, enabling to control devices;
- ◆ Support hot plugging.
- ◆ Simple Web control interface

3.5.2 VIS-CON ENT5 advanced control board function features

- ◆ Two DB9 fully functional serial ports, enabling to control multiple peripherals and to receive commands;
 - ◆ One RJ45 interface, enabling to download, upgrade controlled programming and to query information;
 - ◆ One 4P phoenix-head keyboard interface, enabling to operate with keyboards;
 - ◆ Support hot plugging;
-

3.6 specifications and technical parameters

Model Specifications	MX-HM4I	MX-HM4O
Protocol	HDMI1.3a, HDCP1.3protocol, DVI1.0 protocol;	
Video		
Gain	0dB	
Pixel bandwidth	165MHz, all-digital	
Interface bandwidth	2.25Gbps, all-digital (6.75Gbps in all, each color is 2.25Gbps)	
Supported resolution	800x600@60,1024x768@60,1280x720@60,1280x768@60, 1280x800@60, 1280X60@60, 1280x1024@60,1360x768@60,1366x768@60,1440X00@60,1600X00@60,1600x1200@60,1920x1080@25,1920x1080P@30,1920x1200P@60,1920x1080P@60,1920x1080i@50,1920X1080i@60	
Clock Jitter	<0.15 Tbit	
Rise time	<0.3Tbit (20%--80%)	
Fall time	<0.3Tbit (20%--80%)	
Maximum transmission delay	5nS(±1nS)	
Interface	Four-way HDMI-A interface, four-way 3.5mm audio base	
Signal strength	T.M.D.S. +/- 0.4Vpp	
Minimum/maximum signal level	T.M.D.S. 2.9V/3.3V	
Impedance	50 Ω	
EDID	Default EDID and reading function	N/A
Maximum DC bias error	15mV	
Suggested maximum input/output transmission distance	Maximum transmission distance is 35 meters with 1600x1200@60 (recommend to use certified HDMI dedicated wires, such as Molex TM wire)	Maximum transmission distance is 7 meters with 1600x1200@60 (recommend to use certified HDMI dedicated wires, such as Molex TM wire)
Product weight	About 0.5KG	About 0.5KG
Maximum consumption	15W	15W

Model Specifications	MX-HM2I	MX-HM2O
Protocol	HDMI1.4a, HDCP1.3protocol, DVI1.0 protocol;	
Video		
Gain	0dB	
Pixel bandwidth	297MHz, all-digital	
Interface bandwidth	4.5Gbps, all-digital (13.5Gbps in all, each color is 4.5Gbps)	

Model Specifications	MX-HM2I	MX-HM2O
Supported resolution	800x600@60,1024x768@60,1280x720@60,1280x768@60, 1280x800@60, 1280x960@60, 1280x1024@60,1360x768@60,1366x768@60,1440x900@60,1600x900@60,1600x1200@60,1920x1080@25,1920x1080P@30,1920x1200P@60,1920x1080P@60,1920x1080i@50,1920x1080i@60,4Kx2K@30Hz	
Clock Jitter	<0.15 Tbit	
Rise time	<0.3Tbit (20%--80%)	
Fall time	<0.3Tbit (20%--80%)	
Maximum transmission delay	5nS(±1nS)	
Interface	Two-way HDMI-A interface, two 3.5mm audio output; Two-way 3.5mm audio input on input card VIS-HM2I only	
Signal strength	T.M.D.S. +/- 0.4Vpp	
Minimum/maximum signal level	T.M.D.S. 2.9V/3.3V	
Impedance	50 Ω	
EDID	Default EDID and reading function	N/A
Maximum DC bias error	15mV	
Suggested maximum input/output transmission distance	Maximum transmission distance is 35 meters with 1600x1200@60 (recommend to use certified HDMI dedicated wires, such as Molex TM wire)	Maximum transmission distance is 7 meters with 1600x1200@60 (recommend to use certified HDMI dedicated wires, such as Molex TM wire)
Product weight	About 0.5KG	About 0.5KG
Maximum consumption	20W	20W

Model Specifications	MX-DVI4I	MX-DVI4O
Protocol		
DVI1.0 protocol		
Video		
Gain	0dB	
Pixel bandwidth	165MHz, all-digital	165MHz, all-digital or analog
Interface bandwidth	2.25Gbps, all-digital (6.75Gbps in all, each color is 2.25Gbps)	2.25Gbps all-digital or 350MHz analog

Model Specifications	MX-DVI4I	MX-DVI4O
Supported resolution	800x600@60,1024x768@60,1280x720@60,1280x768@60,1280x800@60,1280X60@60,1280x1024@60,1360x768@60,1366x768@60,1440X00@60,1600X00@60,1600x1200@60,1920x1200P@60,1920x1080P@60, 1920x1080i@50,1920X1080i@60;	
Clock Jitter	<0.15 Tbit	
Rise time	<0.3Tbit (20%--80%)	
Fall time	<0.3Tbit (20%--80%)	
Maximum transmission delay	5nS(±1nS)	
Interface	Four-way DVI-D female interface, four-way 3.5mm audio base	Four-way DVI-I female interface, four-way 3.5mm audio base
Signal strength	T.M.D.S. +/- 0.4Vpp	
Minimum/maximum signal level	T.M.D.S. 2.9V/3.3V	
Impedance	50 Ω	
EDID	Default EDID and reading function	N/A
Maximum DC bias error	15mV	
Suggested maximum input/output transmission distance	Maximum transmission distance is 35 meters with 1600x1200@60 (recommend to use certified HDMI dedicated wires, such as Molex TM wire)	Maximum transmission distance is 7 meters with 1600x1200@60 (recommend to use certified HDMI dedicated wires, such as Molex TM wire)
Product weight	About 0.5KG	About 0.5KG
Maximum consumption	15W	15W

Model Specifications	MX-HD4I	MX-HD4O
Link input/output		
Interface	Four-way high-speed base and four-way 6PIN phoenix base	
Supported protocol	HDBaseT protocol	
Pixel bandwidth	165MHz, all-digital	
Interface bandwidth	2.25Gbps, all-digital (6.75Gbps in all, each color is 2.25Gbps)	
Supported resolution	800x600@60,1024x768@60,1280x720@60,1280x768@60,1280x800@60,1280X60@60,1280x1024@60,1360x768@60,1366x768@60,1440X00@60,1600X00@60,1600x1200@60,1920x1200P@60,1920x1080P@60,1920x1080i@50,1920X1080i@60;	
Signal type	High-speed differential signal defined in HDBaseT protocol	

Model Specifications	MX-HD4I	MX-HD4O
Cable transmission power	POC power supply (+48V), it should be used with our company CAT5 series transmitter which can provide power supply via cables.	POC power supply (+48V), it should be used with our company CAT5 series transmitter which can provide power supply via cables.
Impedance	50 Ω	
EDID	Default EDID	N/A
Maximum DC bias error	15mV	
Suggested maximum input/output transmission distance	Maximum transmission distance is 100 meters with 1600x1200@60 (recommend to use NEXANS CAT5e/6 dedicated wires)	
Product weight	About 0.5KG	About 0.5KG
Maximum consumption	27W	22W

Model Specifications	MX-VA4I	MX-VA4O	
Interface	DB15 interface, 3.5mm audio base		
Supported resolution	Composite video CV	Input board: 480i/NTSC,576i/PAL Output board: 480i/NTSC,576i/PAL	
	Component video YPbPr	Input board:480i/NTSC,480P/NTSC,576i/PAL,576P/PAL,1280x720@50,1280x720@60,1920x1080i@50,1920X1080P@60; Output board: 1280x720@60,1920X1080P@60;	
	VGA video	Input board: 800x600@60,1024x768@60,1280x720@60,1280x768@60,1280x800@60,1280X60@60,1280x1024@60,1360x768@60,1360x1024@60,1366x768@60,1440X00@60,1400x1050@60,1600X00@60,1600x1200@60,1680x1050@60,1920X1080P@60; Output board: 800x600@60,1024x768@60,1280x720@60,1280x768@60,1280x800@60,1280X60@60,1280x1024@60,1360x768@60,1366x768@60,1440X00@60,1600X00@60,1600x1200@60,1920x1200P@60,1920X1080P@60;	
Gain	0dB	0 dB	0 dB
Bandwidth	150MHz @ -3dB	350MHz @ -3dB	380 MHz
Differential phase error	0.1°,3.58-4.43 MHz	0.1°,3.58-4.43 MHz	

Model Specifications	MX-VA4I	MX-VA4O	
Differential gain error	0.1%, 3.58-4.43 MHz	0.1%, 3.58-4.43 MHz	
Signal strength	1V p-p: composite video (CV BS)	1V p-p : (Y in component video) 0.3V p-p: (PbPr/CbCr in component video)	0.63V p-p -- 0.9 V p-p
Minimum/maximum level	Analog signal: -2V/+2V	Analog signal: -2V/+2V	RGB signal: 0V/1.0V HV signal: 0V/5.0V
Impedance	75 Ω	75Ω	75Ω
Return loss	<-30dB@5MHz	<-30dB@5MHz	<-30dB@5MHz
Product weight	About 0.5KG		
Maximum consumption	20W		

Model Specifications	MX-SDI4I	MX-SDI4O
Interface	Four-way BNC input/output, four-way BNC looping out	
Supported protocol	SMPTE 425M, SMPTE 424M, SMPTE 292M, SMPTE 259M-C, DVB-ASI	
Pixel bandwidth	2.970Gb/s, 1.485Gb/s, 270Mb/s,	
Supported resolution	1920x1080@25,1920x1080P@30,1280x720@60,1920X1080P@60,1920x1080i@50,1920X1080i@60;	
Supported format	HD-SDI 3G-SDI	
Product weight	About 0.5KG	
Maximum consumption	20W	

Model Specifications	MX-SF4I	MX-SF4O
Interface	Four-way high-speed single-core SC optical fiber interface	
Video		
Optical fiber interface	SC connector	
Optical fiber type	Multimode/Single Mode(optional)	
Wavelength	Multimode 850nm/Single Mode: 1310 –1620nm(optional)	
Interface bandwidth	Forward: 6.25Gbps, reverse: 3.125Gbps	

Clock Jitter	<0.15 Tbit
Rise time	<0.3Tbit (20%--80%)
Fall time	<0.3Tbit (20%--80%)
Suggested maximum input transmission distance	OM3 multimode optical fiber: <300 meters, single mode optical fiber: 2~20 kilometers, 1920x1080p@60
Supported resolution	800x600@60,1024x768@60,1280x720@60,1280x768@60,1280x800@60,1280X60@60,1280x1024@60,1360x768@60,1366x768@60,1440X00@60,1600X00@60,1600x1200@60,1920x1200P@60,1920X1080P@60,1920x1080i@50,1920X1080i@60;
Product weight	About 0.5KG
Maximum consumption	20W

Model	MX-IP2I
Specifications	
Protocol	RTP, RTCP, RTSP, TCP, UDP RTSP, UDP
Video	
Transmission distance	100m
Compression technology	H264.
Max.Delay Time	100ms
Default IP	192.168.1.180
Network Bandwidth	100M
Max. Resolution	最大支持分辨
Fall time	<0.3Tbit (20%--80%)
Weight	0.5kg
Consumption	25W

Model	VIS-CON ENT4/VIS-CON ENT5
Specifications	
Video	

Network interface band width	100M
Video Compress	H.264&JPEG Multi-stream encoding
Max. transmission delay	100ms (determined by the encoding delay and network transmission delay)
IP parameters	Static IP Default IP:192.168.1.163 Port:5000.
Supported Resolutions and frame rate	1920×1080@30Hz; 1280x720@60fps;1280x720@30fps;
Recommended Max. Input Distance	100m
Product weight	About 0.5KG
Maximum consumption	15W

Model Specifications	VW-VL0808	VW-VL1616	VW-VL3636	VW-VL7272
Interface				
Number of input boards/input channels	2/8	4/16	9/36	18/72
Number of output boards/output channels	2/8	4/16	9/36	18/72
Supported input board type	VW-HM4I; VW-DV4I; MX-HD4I; VW-VA4I; MX-SF4I; MX-SDI4I			
Supported seamless output board type	MX-HM4O; MX-DVI4O; VW-HD4O; MX-VA4O; FIBER-OUT; SDI-OUT;			
Supported stitching output board type	HDMI-SPLICE; DVI-SPLICE; HDBASET-SPLICE; VGA-SPLICE; FIBER-SPLICE; VP-SD4O;			
Interface bandwidth	6.75Gbps			
Serial port control				
Serial control interface	RS-232, 9 pin female D type interface and 9 pin male D type interface			
Baud rate and protocol	Baud rate: 9600, data bits: 8 bits, stop bits: 1 bit, no parity check bit			
Serial control interface structure	9 pin female D type interface : 2 = TX, 3 = RX, 5 = GND; 9 pin male D type interface : 2 = RX, 3 =TX, 5 = GND			
KEYBOARD control interface				
Keyboard control interface	Four-way 3.8mm phoenix interface			
Operation method	To use with extended keyboard MCP100			

Model Specifications	VW-VL0808	VW-VL1616	VW-VL3636	VW-VL7272
Keyboard control interface structure	+5V=DC5V, + = DATA+, -=DATA- GND = signal ground			
Ethernet control				
Ethernet control interface	RJ-45 female interface			
Ethernet control protocol	TCP/IP			
Ethernet control speed rate	Adaptive 10M / 100M, full-duplex or half-duplex			
Specifications				
System power	100VAC ~ 240VAC, 50/60 Hz, International adaptive power			
Storage, work temperature	0 ~ +50°C			
Storage, work humidity	20% ~70%			
Chassis size	2U	3U	7U	12U
Product weight (without boards)	About 5Kg	About 7Kg	About 16Kg	About 29Kg
Full power (without boards)	About 18W		About 30W	
Size	445x400x88	445x400x132	445x400x310	445x400x532
Mean time between failures	30,000 hours			
Quality guarantee	One year warranty and lifetime maintenance			

Chapter Four Instructions

4.1 M5 series Matrix Switcher instructions

Serial port protocol: baud rate: 9600, data bits: 8, stop bits: 1, parity bits: none

Ethernet: protocol: TCP, IP: 192.168.1.190, PORT: 6666

Meanings of instructions:

[X1], [X2]... [Xn] represents the corresponding input port;

[Y1], [Y2]... [Yn] represents the corresponding output port;

[TX1], [TX2]... [TXn] represents the corresponding input port's serial port/infrared transmitter channel;

[RX1], [RX2]... [RXn] represents the corresponding input port's serial port/infrared receiver channel; [TY1],

[TY2]... [TYn] represents the corresponding output port's serial port/infrared transmitter channel;

[RY1], [RY2]... [RYn] represents the corresponding output port's serial port/infrared receiver channel;

H represents Arabic numerals; n in the number of the corresponding model's input/output interface, such as VW-VL7272, the maximum value of n is 72.



[] of [x] in the following instruction list is annotation, in practice, it should be removed. For example, \$[x]AudioA! should be \$8AudioA! in practice.

Instructions (pc-->X)	Functions	Returned information	Examples
System instructions			
/:BellOff;	Close buzzer	<Closed The Bell.>	/:BellOff;
/:BellOn;	Open buzzer	<Opened The Bell.>	/:BellOn;
/:MessageOff;	Close serial port return, only few characters such as SWITCH or OK! is allowed	<Closed The Message Return.>	/:MessageOff;
/:MessageOn;	Open serial port return	<Enabled The Message Return.>	/:MessageOn;
/:HeartBeat;	PC software heartbeat	<HeartBeat>	/:HeartBeat;
\$Default!	Control board restore default(control board reset and restart)	None	\$Default!
\$(X1)DefaultIn!	Restore channel [X1] default input	<Set Succeed!>	\$(1)DefaultIn!
\$(Y1)DefaultOut!	Restore channel [Y1] default output	<Set Succeed!>	\$(1)DefaultOut!
\$(All)DefaultIn!	Restore all default input	<Set Succeed!>	\$(All)DefaultIn!
\$(All)DefaultOut!	Restore all default output	<Set Succeed!>	\$(All)DefaultOut!
Status [Y1].	Query channel [X1] output current status	V:[x1] -> [Y1];	Status1.
Status.	Query all output channels current status	V:[x1] -> [Y1];	Status.
Save [H].	Save current state to [H], [Y] is number 0 - 9	<Save to F1!>	Save8.
Recall [H].	Recall [H], [H] is number 0-9	<Recall from F1!>	Recall8.
Clear [H].	Clear data of [H]	<Clear F1!>	Clear8.
FanTemp[H].	Set fan temperature, start fan at [H]	<Set Succeed!>	FanTemp30.

<control/.../>	Control screen ... The instructions to control the big screen, supported maximum bit is 50 bits. In controlling the network, data is forwarded from serial port 0, while data is forwarded from another serial port in controlling the serial port.	<Set Succeed!>	<control/open com0/>
----------------	---	----------------	----------------------

Instructions to acquire board information

/:ScanPortType;	Scan card slot	<Port/37/In/HDMI/Ver3.1/Ver1.2>	/:ScanPortType;
/:ScanPortResolution;	Scan all input/output boards resolution	<Resolution/37/In/noinput>	/:ScanPortResolution;
\${X1}ReadInResolution!	Acquire channel [X1] input board resolution	<Resolution/37/In/noinput>	\${1}ReadInResolution!
\${Y1}ReadOutResolution!	Acquire channel [Y1] output board resolution	<Resolution/37/Out/unknown>	\${1}ReadOutResolution!
\${X1}ReadInType!	Acquire channel [X1] input board type	<Type/37/In/HDMI>	\${1}ReadInType!
\${Y1}ReadOutType!	Acquire channel [Y1] output board type	<Type/37/Out/HDMI>	\${1}ReadOutType!
\${X1}TemperatureIn!	Acquire channel [X1] input board temperature	<temp/[37,40]/In/24.5>	\${1}TemperatureIn!
\${Y1}TemperatureOut!	Acquire channel [Y1] output board temperature	<temp/[37,40]/Out/24.5>	\${1}TemperatureOut!
AllTemperatureIn!	Analyze all channels input board temperature	<temp/[37,40]/In/24.5> <temp/[65,68]/In/25.5>	AllTemperatureIn!
AllTemperatureOut!	Analyze all channels output board temperature	<temp/[37,40]/Out/24.5> <temp/[61,64]/Out/26.5>	AllTemperatureOut!
AllAnalyseOut!	Analyze all output chips work status		AllAnalyseOut!
AllAnalyseIn!	Analyze all input chips work status		AllAnalyseIn!
\${X1}AnalyseIn!	Analyze work status of channel [X1] input board chips		\${1}AnalyseIn!
\${Y1}AnalyseOut!	Analyze work status of channel [Y1] output board chips		\${1}AnalyseOut!

Instructions to choose audio infrared serial port

\${X1}AudioA!	Select channel [X1] input board analog audio/phenix infrared serial port input	<Set Succeed!>	\${1}AudioA!
\${X1}AudioD!	Select channel [X1] input board signal audio/network infrared serial port input	<Set Succeed!>	\${1}AudioD!

\$[Y1]AudioAOut!	Select channel [Y1] output board infrared serial port phoenix output	<Set Succeed!>	\$1AudioAOut!
\$[Y1]AudioDOut!	Select channel [Y1] output board infrared serial port output	<Set Succeed!>	\$1AudioDOut!
EDID management instructions	(in acquiring EDID, EDID data is between <EDID Start/ and /EDID End>. If you want to update or edit EDID on PC, send Update EDID[X1] first to assign a path, then sent updated EDID data, in the end, send UpdateEnd.		
GetInEDID[X1].	Acquire channel [X1] input board EDID (HDMI DVI board effective, is the EDID of current device)	<EDID Start/.../EDID End>	GetInEDID1.
GetOutEDID[Y1].	Acquire channel [Y1] output board EDID (HDMI DVI board effective, is the EDID of current device)	<EDID Start/.../EDID End>	GetOutEDID1.
[Y1]EDIDTo[X1].	Read and output channel [Y1] EDID, and input it to channel [X1] (HDMI DVI board effective)	<Set EDID succeed!>	1EDIDTo1.
UpdateEDID[X1].	Update channel [X1] EDID on PC, (HDMI DVI board effective)	<Update EDID start!>	UpdateEDID1.
UpdateEnd.	Exit update EDID	<Exit Update EDID!>	UpdateEnd.
Instructions to switch audio			
[X1]V[Y1].	Channel [X1] input, channel [Y1] output, the audio is switched. When [X1] is 0, it represents closing channel Y1 audio.	V:[X1] -> [Y1];	1V1.
[X1]v[Y1].	Channel [X1] input, channel [Y1] output, the audio is switched. When [X1] is 0, it represents closing channel Y1 audio.	v:[X1] -> [Y1];	1v1.
[X1]B[Y1].	Channel [X1] input, channel [Y1] output, the audio is switched. When [X1] is 0, it represents closing channel Y1 audio.	B:[X1] -> [Y1];	1B1.
[X1]b[Y1].	Channel [X1] input, channel [Y1] output, the audio is switched. When [X1] is 0, it represents closing channel Y1 audio.	b:[X1] -> [Y1];	1b1.
[X1]V[Y1],[Y2],[Y3]	Channel [X1] input, channel [Y1][Y2][Y3] output	V:[X1] -> [Y1];	1V1,2,3.
[X1]All.	Channel [X1] input, all channels output. When [X1] is 0, it represents closing all channel audio.	V:[X1] -> [x2];	1All.
All\$.	Close all channels	V:[X1] -> [x2];	All\$.
[X1]\$.	Close channel [X1] output	V:[X1] -> [x2];	1\$.
All#.	Input channels and output channels are mapped respectively.	V:[X1] -> [x2];	All#.
Demo.	The system is set at demo mode. In this mode, each input/output channel will be switched in turn; the time interval is 3 seconds.	<System enter into demo mode!>	Demo.

Instructions to control the network			
<^SPORT>	Query the port number of current matrix network	<SPORT:[X1]>	<^SPORT>
<^SIPR>	Query the IP of current matrix network	<SIPR:[X1].[X2].[X3].[X4]>	<^SIPR>
<^SUBR>	Query the subnet mask of current matrix network	<SUBR:[X1].[X2].[X3].[X4]>	<^SUBR>
<^GAR>	Query the gateway of current matrix network	<GAR:[X1].[X2].[X3].[X4]>	<^GAR>
<^SHAR>	Query hardware address of current matrix network	<SHAR:[X1].[X2].[X3].[X4].[X5].[X6]>	<^SHAR>
<#SPORT[5000]>	Set port number of matrix network(take effect after re-power)	<Set Network Succeeded!>	<#SPORT5000>
<#SIPR[192]. [168]. [0]. [2]>	Set IP of matrix network(take effect after re-power)	<Set Network Succeeded!>	<#SIPR192. 168. 0. 23>
<#GAR[192]. [168]. [0]. [1]>	Set gateway of matrix network(take effect after re-power)	<Set Network Succeeded!>	<#GAR192. 168. 0. 11>
<#SUBR[255]. [255]. [255]. [0]>	Set subnet mask of matrix network(take effect after re-power)	<Set Network Succeeded!>	<#SUBR255. 255. 255. 0>
<#SHAR[00]. [11]. [22]. [33]. [44]. [55]>	Set hardware address(hex) of matrix network(take effect after re-power)	<Set Network Succeeded!>	<#SHAR00. 11. 22. 33. 44. 55>
<#NETDEFAULT>	Network configuration restore to factory settings(take effect after re-power)	<Set Network Succeeded!>	<#NETDEFAULT>
Instructions to control preview boards			
<^HSSPORT>	Query the port number of preview board network	<HSPORT:[X1]>	<^SPORT>
<^HSSIPR>	Query the IP of preview board network	<HSIPR:[X1].[X2].[X3].[X4]>	<^SIPR>
<^HSSUBR>	Query the subnet mask of preview board network	<HSUBR:[X1].[X2].[X3].[X4]>	<^SUBR>
<^HSGAR>	Query the gateway of preview board network	<HGAR:[X1].[X2].[X3].[X4]>	<^GAR>
<^HSSHAR>	Query hardware address of preview board network	<HSHAR:[X1].[X2].[X3].[X4].[X5].[X6]>	<^SHAR>
<#HSSPORT[5000]>	Set port number of preview board network(take effect after re-power)	<Set Network Succeeded!>	<#SPORT[5000]>
<#HSSIPR[192]. [168]. [0]. [2]>	Set IP of preview board network(take effect after re-power)	<Set Network Succeeded!>	<#SIPR192. 168. 0. 23>

<#HSGAR [192]. [168]. [0]. [1]>	Set gateway of preview board network(take effect after re-power)	<Set Network Succeed!>	<#GAR192. 168. 0. 11>
<#HSSUBR [255]. [255]. [5]. [255]. [0]>	Set subnet mask of preview board network(take effect after re-power)	<Set Network Succeed!>	<#SUBR255. 255. 255. 0>
<#HSSHAR [00]. [11]. [22]. [33]. [44]. [55]>	Set hardware address(hex) of preview board network(take effect after re-power)	<Set Network Succeed!>	<#SHAR0. 11. 22. 33. 44. 55>
<#HSNETDEFAULT>	Network configuration restore to factory settings	<Set Network Succeed!>	<#NETDEFAULT>
<^HSResolution1280*720>	Coding resolution of preview board is set as 1280*720	<Set Succeed!>	<^HSResolution1280*720>
<^HSResolution800*600>	Coding resolution of preview board is set as 800*600	<Set Succeed!>	<^HSResolution800*600>
<^HSResolution640*480>	Coding resolution of preview board is set as 640*480	<Set Succeed!>	<^HSResolution640*480>
<^HSResolution352*288>	Coding resolution of preview board is set as 352*288	<Set Succeed!>	<^HSResolution352*288>
<^HSResolution>	Query current resolution of preview board	<^HSResolution_is_1280*720> or <^HSResolution_is_800*600> or <^HSResolution_is_640*480> or <^HSResolution_is_352*288>	Multicast address is 224.1.1.1---224.1.1.2, the port is Port+2, Ports+4, Port+6, Port+8 (Port is TCP linking port)

Instructions to switch infrared serial port

[RX1]R[TY1].	Link serial port receiving channel [RX1] of input port to serial port sending channel [TY1] of output port (RS232 forward channel switching)	RS:[RX1]->[TY1];	1R2.
[RY1]S[TX1].	Link serial port receiving channel [RY1] of output port to serial port sending channel [TX1] of input port	TS:[RY1]->[TX1];	1S2.
[RX1]Q[TY1].	Link infrared receiving channel [RX1] of input port to infrared sending channel [TY1] of output port (IR forward channel switching)	IR:[RX1]->[TY1];	1Q2.
[RY1]F[TX1].	Link infrared receiving channel [RY1] of output port to infrared sending channel [TX1] of input port	TR:[RY1]->[TX1];	2F1.
[RX1]T[TY1].	Link serial port/infrared receiving channel [RX1] of input port to serial port/infrared sending channel [TY1] of output port (RS232/IR forward channel switching)	T:[RX1]->[TY1];	1T2.

Instructions to change single output resolution

\$[Y1]->800x600x60Hz!	Channel [Y1] output resolution is 800x600x60Hz(except SDI)	<Set Resolution Succeeded!>	\$1->800x600x60Hz!
\$[Y1]->1024x768x60Hz!	Channel [Y1] output resolution is 1024x768x60Hz(except SDI)	<Set Resolution Succeeded!>	\$1->1024x768x60Hz!
\$[Y1]->1280x720x50Hz!	Channel [Y1] output resolution is 1280x720x60Hz(except SDI)	<Set Resolution Succeeded!>	\$1->1280x720x50Hz!
\$[Y1]->1280x720x60Hz!	Channel [Y1] output resolution is 1280x720x60Hz	<Set Resolution Succeeded!>	\$1->1280x720x60Hz!
\$[Y1]->1280x768x60Hz!	Channel [Y1] output resolution is 1280x768x60Hz(except SDI)	<Set Resolution Succeeded!>	\$1->1280x768x60Hz!
\$[Y1]->1280x800x60Hz!	Channel [Y1] output resolution is 1280x800x60Hz(except SDI)	<Set Resolution Succeeded!>	\$1->1280x800x60Hz!
\$[Y1]->1280X60x60Hz!	Channel [Y1] output resolution is 1280X60x60Hz(except SDI)	<Set Resolution Succeeded!>	\$1->1280X60x60Hz!
\$[Y1]->1280x1024x60Hz!	Channel [Y1] output resolution is 1280x1024x60Hz(except SDI)	<Set Resolution Succeeded!>	\$1->1280x1024x60Hz!
\$[Y1]->1360x768x60Hz!	Channel [Y1] output resolution is 1360x768x60Hz (except SDI)	<Set Resolution Succeeded!>	\$1->1360x768x60Hz!
\$[Y1]->1366x768x60Hz!	Channel [Y1] output resolution is 1366x768x60Hz(except SDI)	<Set Resolution Succeeded!>	\$1->1366x768x60Hz!
\$[Y1]->1440X00x60Hz!	Channel [Y1] output resolution is 1440X00x60Hz(except SDI)	<Set Resolution Succeeded!>	\$1->1440X00x60Hz!
\$[Y1]->1600X00x60Hz!	Channel [Y1] output resolution is 1600X00x60Hz(except SDI)	<Set Resolution Succeeded!>	\$1->1600X00x60Hz!
\$[Y1]->1600x1200x60Hz!	Channel [Y1] output resolution is 1600x1200x60Hz(except SDI)	<Set Resolution Succeeded!>	\$1->1600x1200x60Hz!
\$[Y1]->1920x1080x25Hz!	Channel [Y1] output resolution is 1920x1080x25Hz(SDI HDMI board is valid)	<Set Resolution Succeeded!>	\$1->1920x1080x25Hz!
\$[Y1]->1920x1080x30Hz!	Channel [Y1] output resolution is 1920x1080x30Hz(SDI HDMI board is valid)	<Set Resolution Succeeded!>	\$1->1920x1080x30Hz!
\$[Y1]->1920x1080x50Hz!	Channel [Y1] output resolution is 1920x1080x60Hz	<Set Resolution Succeeded!>	\$1->1920x1080x50Hz!

\$[Y1]->1920x1080x60Hz!	Channel [Y1] output resolution is 1920x1080x60Hz	<Set Resolution Succeeded!>	\$1->1920x1080x60Hz!
\$[Y1]->1920x1200x60Hz!	Channel [Y1] output resolution is 1920x1200x60Hz(except SDI)	<Set Resolution Succeeded!>	\$1->1920x1200x60Hz!
\$[Y1]->1920x540x50Hz!	Channel [Y1] output resolution is 1920x540x50Hz(1920x1080ix50Hz)	<Set Resolution Succeeded!>	\$1->1920x540x50Hz!
\$[Y1]->1920x540x60Hz!	Channel [Y1] output resolution is 1920x540x60Hz(1920x1080ix60Hz)	<Set Resolution Succeeded!>	\$1->1920x540x60Hz!
Instructions to change all output resolution			
\$All->800x600x60Hz!	All channel resolution is 800x600x60Hz(except SDI)	<Set Resolution Succeeded!>	\$All->800x600x60Hz!
\$All->1024x768x60Hz!	All channel resolution is 1024x768x60Hz(except SDI)	<Set Resolution Succeeded!>	\$All->1024x768x60Hz!
\$All->1280x720x50Hz!	All channel resolution is 1280x720x50Hz(except SDI)	<Set Resolution Succeeded!>	\$All->1280x720x50Hz!
\$All->1280x720x60Hz!	All channel resolution is 1280x720x60Hz	<Set Resolution Succeeded!>	\$All->1280x720x60Hz!
\$All->1280x768x60Hz!	All channel resolution is 1280x768x60Hz(except SDI)	<Set Resolution Succeeded!>	\$All->1280x768x60Hz!
\$All->1280x800x60Hz!	All channel resolution is 1280x800x60Hz(except SDI)	<Set Resolution Succeeded!>	\$All->1280x800x60Hz!
\$All->1280X60x60Hz!	All channel resolution is 1280X60x60Hz(except SDI)	<Set Resolution Succeeded!>	\$All->1280X60x60Hz!
\$All->1280x1024x60Hz!	All channel resolution is 1280x1024x60Hz(except SDI)	<Set Resolution Succeeded!>	\$All->1280x1024x60Hz!
\$All->1360x768x60Hz!	All channel resolution is 1360x768x60Hz(except SDI)	<Set Resolution Succeeded!>	\$All->1360x768x60Hz!
\$All->1366x768x60Hz!	All channel resolution is 1366x768x60Hz(except SDI)	<Set Resolution Succeeded!>	\$All->1366x768x60Hz!
\$All->1440X00x60Hz!	All channel resolution is 1440X00x60Hz(except SDI)	<Set Resolution Succeeded!>	\$All->1440X00x60Hz!
\$All->1600X00x60Hz!	All channel resolution is 1600X00x60Hz(except SDI)	<Set Resolution Succeeded!>	\$All->1600X00x60Hz!
\$All->1600x1200x60Hz!	All channel resolution is 1600x1200x60Hz(except SDI)	<Set Resolution Succeeded!>	\$All->1600x1200x60Hz!
\$All->1920x1080x50Hz!	All channel resolution is 1920x1080x50Hz	<Set Resolution Succeeded!>	\$All->1920x1080x50Hz!
\$All->1920x1080x25Hz!	All channel resolution is 1920x1080x25Hz(SDI HDMI is valid)	<Set Resolution Succeeded!>	\$All->1920x1080x25Hz!

\$All->1920x1080x30Hz!	All channel resolution is 1920x1080x30Hz(SDI HDMI is valid)	<Set Resolution Succeeded!>	\$All->1920x1080x30Hz!
\$All->1920x540x50Hz!	All channel resolution is 1920x540x50Hz(1920x1080x50Hz)	<Set Resolution Succeeded!>	\$All->1920x540x50Hz!
\$All->1920x1080x60Hz!	All channel resolution is 1920x1080x60Hz	<Set Resolution Succeeded!>	\$All->1920x1080x60Hz!
\$All->1920x540x60Hz!	All channel resolution is 1920x540x60Hz(1920x1080x60Hz)	<Set Resolution Succeeded!>	\$All->1920x540x60Hz!
\$All->1920x1200x60Hz!	All channel resolution is 1920x1200x60Hz(except SDI)	<Set Resolution Succeeded!>	\$All->1920x1200x60Hz!

Instructions for VGA output board to output signals

[\$Y1]VGAOut!	Set channel Y1] output board as VGA output	<The Port Signal Setting Succeeded!>	\$1VGAOut!
[\$Y1]YUVOut!	Set channel Y1] output board as YUV output	<The Port Signal Setting Succeeded!>	\$1YUVOut!

Instructions to adjust VGA input/output signals (choose the channel before setting corresponding parameters VGA)

SetVGAIn[X1].	Set channel [X1] VGA input signal	<Set Succeeded!>	SetVGAIn1.
SetVGAOut[Y1].	Set channel [Y1] VGA output signal	<Set Succeeded!>	SetVGAOut1.
Bright[H].	Set brightness value of channel [X1] as H (VGA IN/OUT:50)(range from 0 to 100)	<Set Succeeded!>	Bright50.
Contrast[H].	Set contrast value of channel [X1] as H (VGA IN/OUT:50)(range from 0 to 100)	<Set Succeeded!>	Contrast50.
Saturation[H].	Set saturation value of channel [X1] as H (VGA IN:50)VGA input is valid (range from 0 to 100)	<Set Succeeded!>	Saturation50.
Sharp[H].	Set sharp value of channel [X1] as H (VGA IN:50)VGA input is valid (range from 0 to 100)	<Set Succeeded!>	Sharp50.
Red[H].	Set Red value of channel [X1] as H (VGA IN:128)VGA input is valid (range from 0 to 255)	<Set Succeeded!>	Red128.
Green[H].	Set Green value of channel [X1] as H (VGA IN:128)VGA input is valid (range from 0 to 255)	<Set Succeeded!>	Green128.
Blue[H].	Set Blue value of channel [X1] as H (VGA IN:128)VGA input is valid (range from 0 to 255)	<Set Succeeded!>	Blue128.
AutoConfig.	Set channel [X1] automatic adjustment (VGA input is valid)	<Set Succeeded!>	AutoConfig.
HPosUp.	Set channel [X1] horizontal position +1 (VGA input is valid)	<Set Succeeded!>	HPosUp.
HPosDown.	Set channel [X1] horizontal position -1 (VGA input is valid)	<Set Succeeded!>	HPosDown.
VPosUp.	Set channel [X1] vertical position +1 (VGA input is valid)	<Set Succeeded!>	VPosUp.

VPosDown.	Set channel [X1] vertical position -1 (VGA input is valid)	<Set Succeed!>	VPosDown.
HSizeUp.	Set channel [X1] horizontal size +1 (VGA input is valid)	<Set Succeed!>	HSizeUp.
HSizeDown.	Set channel [X1] horizontal size -1 (VGA input is valid)	<Set Succeed!>	HSizeDown.
VSizeUp.	Set channel [X1] vertical size +1 (VGA input is valid)	<Set Succeed!>	VSizeUp.
VSizeDown.	Set channel [X1] vertical size -1 (VGA input is valid)	<Set Succeed!>	VSizeDown.
PosReset.	Set channel [X1] video position reset (VGA input is valid)	<Set Succeed!>	PosReset.

4.2 Splicer instructions

instructions (pc-->MAX72)	Functions	Returned information
<#MARGIN[X1],[x1]>	Screen spacing of video wall: [X1]: video wall identification [x1]: screen spacing	<Set Succeed!>
<#MAP[X1],[x1],[x2]>	Window x1 of video wall x mapped to output port x2	<Set Succeed!>
<#SIZE[X1],[x1],[x2]>	Window size of PC: [X1]: video wall identification [x1]: horizontal size [x2]: vertical size	<Set Succeed!>
<#VIR[X1],[x1],[x2]>	Window array of PC: [X1]: video wall identification [x1]: number of horizontal windows [x2]: number of vertical windows	<Set Succeed!>
<#OPEN[X1],[x1],[x2],[x3],[x4],[x5],[x6],[x7]>	Setting parameters of opening new windows: [X1]: video wall identification [x1]: window identification [x2]: input source [x3]: layer number [x4]: window horizontal position [x5]: window vertical position [x6]: window horizontal length [x7]: window vertical length	<Set Succeed!>
<#MOVE[X1],[x1],[x2],[x3]>	Setting parameters of moving windows: [X1]: video wall identification [x1]: window identification [x2]: window horizontal position [x3]: window vertical position	<Set Succeed!>
<#RESIZE[X1],[x1],[x2],[x3],[x4],[x5]>	Setting parameters of stretching windows: [X1]: video wall identification [x1]: window identification [x2]: window horizontal position [x3]: window vertical position [x4]: window horizontal size [x5]: window vertical size	<Set Succeed!>
<#LAYER[X1],[x1],[x2]>	Setting parameters of window layers: [X1]: video wall identification [x1]: window identification [x2]: layer number	<Set Succeed!>

<#CLOSE[X1],[x1]>	Window closing setting: [X1]: video wall identification [x1]: window identification	<Set Succeed!>
<^JOINT>	Query spicing state of all video walls	<OPEN[X1],[x1],[x2],[x3],[x4],[x5],[x6],[x7]>
<^SIZE>	Query window size of PC	<SIZE[X1],[x1],[x2]>
<^VIR>	Query window array of PC	<VIR[X1],[x1],[x2]>
<^MAP>	Query mapping relation	<MAP[X1],[x1],[x2]>
<^MARGIN>	Query the setting parameters of screen pitch	<MARGIN[X1],[x1]>

Chapter Five Software

5.1 Connection

1. Connect your PC to the Matrix on Ethernet by CAT5 cable for TCP/IP communication.

The default IP of matrix:192.168.1.190 Port:6666

2. Please set your PC as the bellowing IP

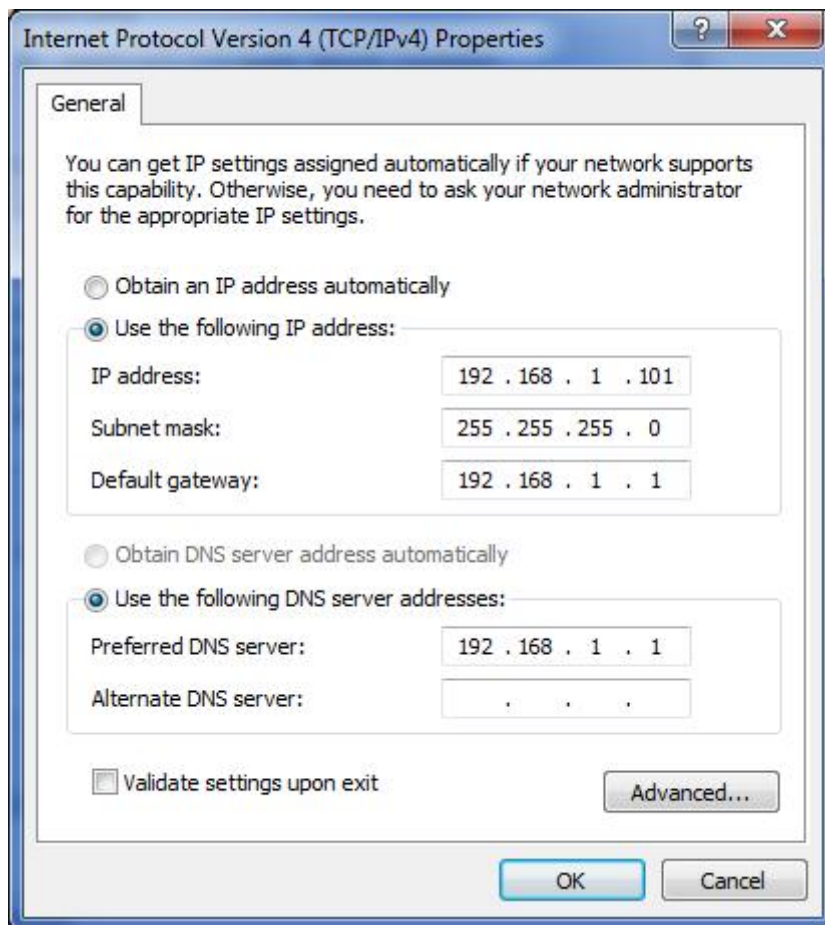

3.Lauch the software



You will get the login interface as bellowing,

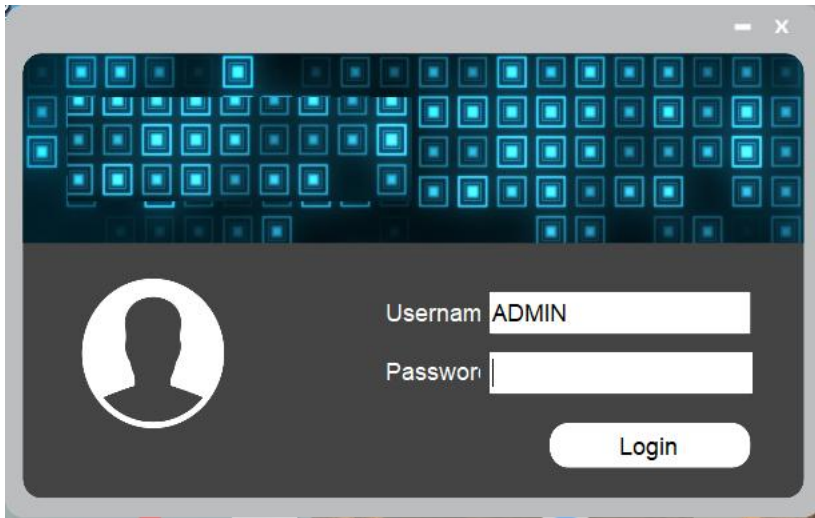

User name: ADMIN

Password: admin

4.Click 'Connect' to connection.

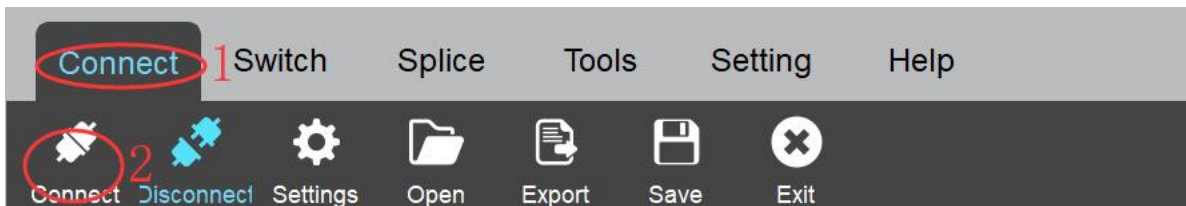

Connection status will display on the top bar

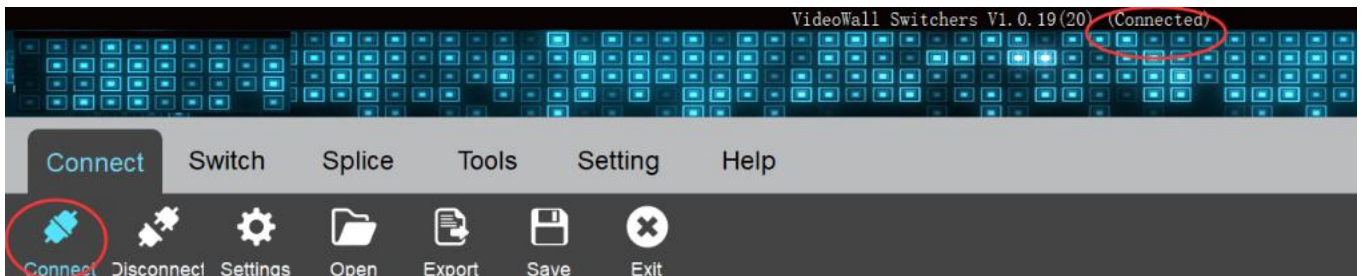

5.2 Matrix switching control (Seamless output card is needed)

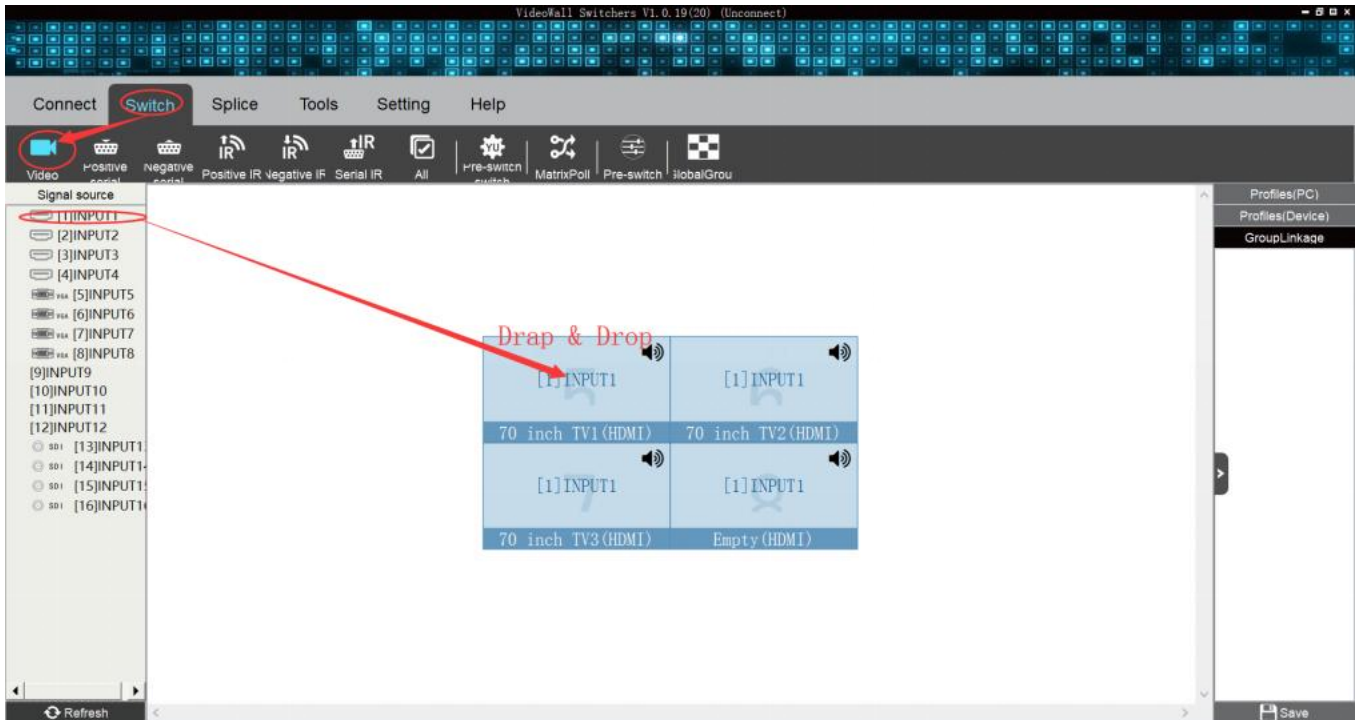

Chapter Six Web Control Based on VIS-CON ENT4

6.1 Connection

1. Connect your PC to the Matrix on Ethernet by CAT5 cable for TCP/IP communication.

The default IP of matrix:192.168.1.191 for web control

2. Please set your PC as the bellowing IP

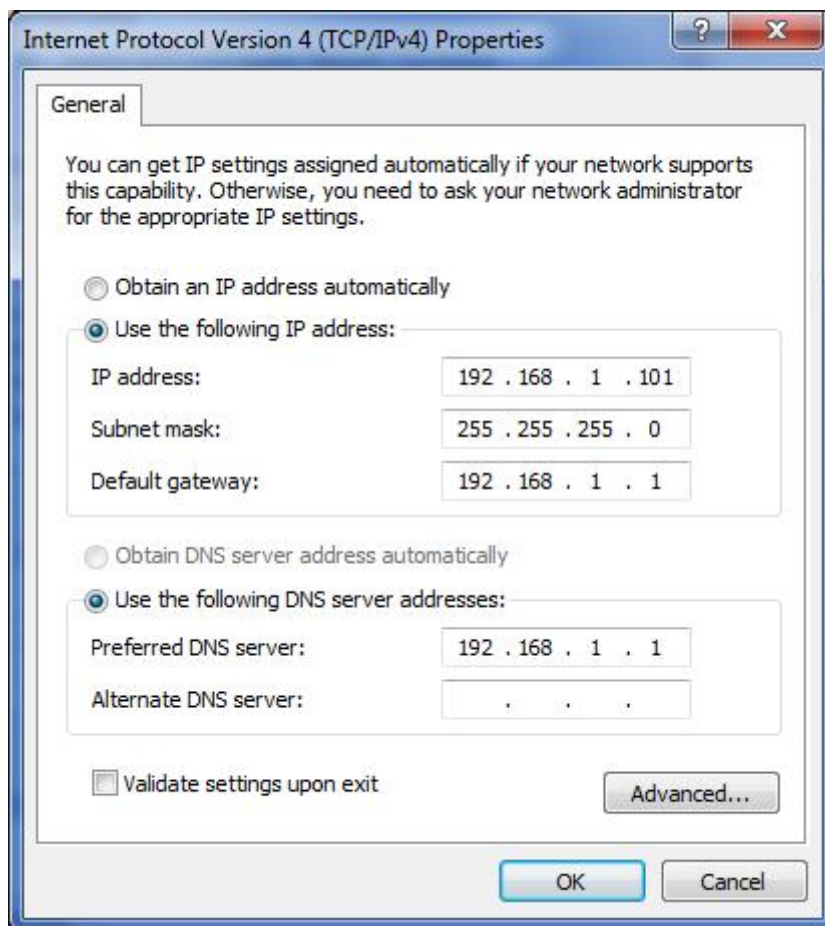

3. Input the IP to web browser and input the

User: admin

Password: admin



4. Web control interface and function

Grid Control for **Matrix 8x8** and **Matrix 16x16**—Switch the input to output (Seamless output card is needed)

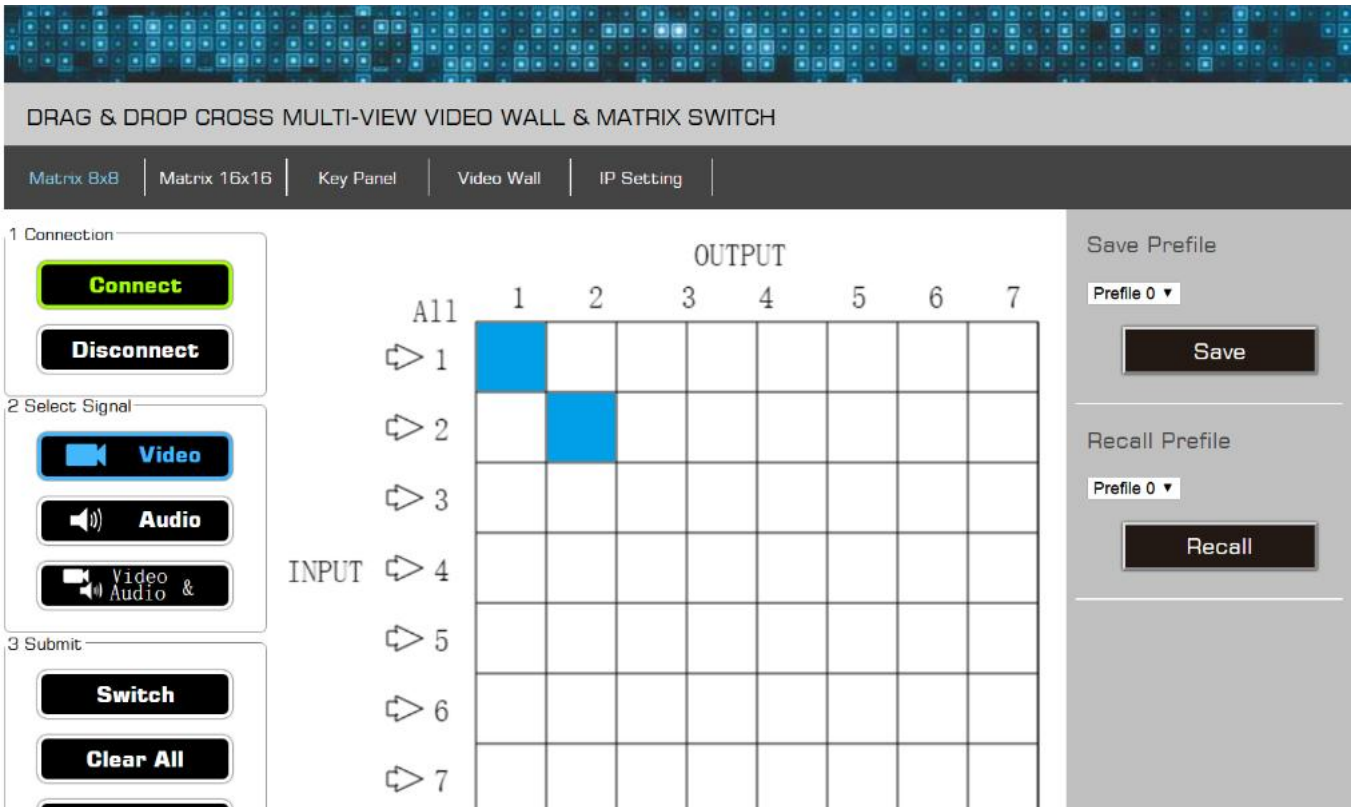

Click the arrow, input switch to all output
 Click the grid to switch the input no. to output no.

Key Panel provide the same interface as the front panel of matrix on the Web page



Video Wall

1. Switch the input to window output on the video wall by click
2. Save and Call the profiles

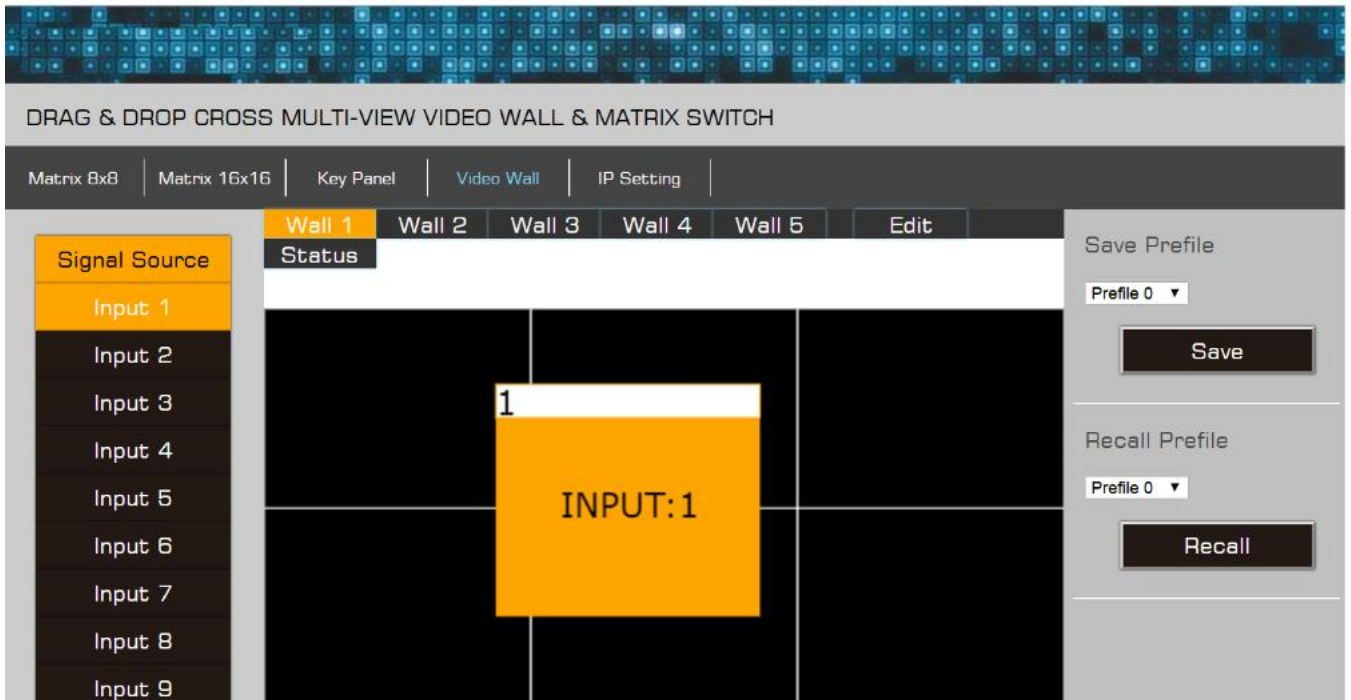

IP setting for WEB port and ETHERNET port.

