

VISSONIC

CLEACON Full Digital Network DSP Conference System User Manual V4.1









VISSONIC ELECTRONICS LIMITED

The meaning of symbols

■ Safety instructions

For your safe and correct use of equipments, we use a lot of symbols on the equipments and in the manuals, demonstrating the risk of body hurt or possible damage to property for the user or others. Indications and their meanings are as follow. Please make sure to correctly understand these instructions before reading the manual.

	<p>This is A level product, which may cause radio interference in the living environment. In this case, users may need to take the feasible measures to get around the interference.</p>
	<p>Remind users that the dangerous voltage without insulation occurring within the equipment may cause people suffer from shock.</p>
	<p>CE certification means that the product has reached the directive safety requirements defined by the European Union. Users can be assured about the use of it.</p>
	<p>SGS certification means that the product has reached the quality inspection standards proposed by the world's largest SGS.</p>
	<p>This product passed the ISO9001 international quality certification (certification body: TUV Rheinland, Germany).</p>
	<p>Warning: in order to avoid electrical shock, do not open the machine cover, nor is the useless part allowed to be placed in the box. Please contact the qualified service personnel.</p>

■ General information instructions

	<p>It lists the factors leading to the unsuccessful operation or set and the relevant information to pay attention.</p>
---	---

Important note



Warning

In order to ensure the reliable performance of the equipment and the safety of the user, please observe the following matters during the process of installation, use and maintenance:

The matters needing attention of installation

- ◆ Please do not use this product in the following places: the place of dust, soot and electric conductivity dust, corrosive gas, combustible gas; the place exposed to high temperature, condensation, wind and rain; the occasion of vibration and impact . Electric shock, fire, wrong operation can lead to damage and deterioration to the product, either;
- ◆ In processing the screw holes and wiring, make sure that metal scraps and wire head will not fall into the shaft of controller, as it could cause a fire, fault, or incorrect operation;
- ◆ When the installation work is over, it should be assured there is nothing on the ventilated face, including packaging items like dust paper. Otherwise this may cause a fire, fault, incorrect operation for the cooling is not free;
- ◆ Should avoid wiring and inserting cable plug in charged state, otherwise it is easy to cause the shock, or electrical damage;
- ◆ The installation and wiring should be strong and reliable, contact undesirable may lead to false action;
- ◆ For a serious interference in applications, should choose shield cable as the high frequency signal input or output cable, so as to improve the anti-jamming ability of the system.

Attention in the wiring

- ◆ Only after cutting down all external power source, can install, wiring operation begin, or it may cause electric shock or equipment damage;
- ◆ This product grounds by the grounding wires .To avoid electric shocks, grounding wires and the earth must be linked together. Before the connection of input or output terminal, please make sure this product is correctly grounded;
- ◆ Immediately remove all other things after the wiring installation. Please cover the terminals of the products cover before electrification so as to avoid cause electric shock.

Matters needing attention during operation and maintenance

- ◆ Please do not touch terminals in a current state, or it may cause a shock, incorrect operation;
- ◆ Please do cleaning and terminal tighten work after turning off the power supply. These operations can lead to electric shock in a current state;
- ◆ Please do the connection or dismantle work of the communication signal cable , the expansion module cable or control unit cable after turning off the power supply, or it may cause damage to the equipment, incorrect operation;
- ◆ Please do not dismantle the equipment, avoid damaging the internal electrical component;
- ◆ Should be sure to read the manual, fully confirm the safety, only after that can do program changes, commissioning, start and stop operation.

Matters needing attention in discarding product

- ◆ Electrolytic explosion: the burning of electrolytic capacitor on circuit boards may lead to explosion;
- ◆ Please collect and process according to the classification, do not put into life garbage;
- ◆ Please process it as industrial waste, or according to the local environmental protection regulations.

Preface

This manual mainly describes the use, performance parameters and troubleshooting of VISSONIC Full Digital Network DSP Conference System - including desktop, embedded, array unit and 5G WiFi wireless conference system.

If the technical parameters and system usage in this manual are changed, the manufacturer will update the version of the manual. Please use the latest user manual.

The copyright of the manual belongs to VISSONIC ELECTRONICS LIMITED. This manual is protected by the Copyright Law of the People's Republic of China and other intellectual property laws and regulations. Without permission, it is not allowed to copy part or all of the manual or modify this manual.

Version	Update	Date
1.3	2.2 Extension Main Unit VIS-EXM 9. 2.4 Connection Box 10. 5.7 CONTROL 19. 6.1.5 Camera Setup& Example 28.	2017.1.18
1.3.1	6.1.2 Zone Setup 25.	2017.2.6
1.3.2	5.3 Audio outputs 18.	2017.2.7
1.3.3	6.1.5 Camera Setup& Example 28 (Change the flow diagram).	2017.3.11
1.3.4	Add WIFI model, flush model.	2017.6.21
1.3.5	6.3 Configure the AP. 7.5 Default setting.	2017.6.27
1.3.6	Update manual for AP.	2020.4.8
1.3.7	COM port definition connection.	2020.7.17
1.3.9	Adding menu and POE.	2022.4.22
3.3	Modifying and Adding menu& capacity.	2023.4.10
4.0	New version released. Adding: VIS-DMD/MAU/MAW/DVCIC/DVDIC/WVCIC/WVDIC-T, VIS-FFC/FFD-F1/F2, VIS-INT64, VIS-WCH2, POE speaker ID, debug setting, Chapter 1 and 8. Updating controller menu. Modifying AP web page, audio zone and camera tracking, etc.	2023.7.26
4.1	Add multiple model products and details modifications.	2023.8.15

Contents

1. System overview	8
1.1 System features	8
1.2 System composition	11
2. Conference controller.....	13
2.1 VIS-DCP2000-D/W conference controller	13
2.1.1 Features and interfaces	13
2.1.2 Installation.....	15
2.1.3 Connection	15
2.1.3.1 Connecting the power supply	15
2.1.3.2 Connecting audio inputs.....	16
2.1.3.3 Connecting audio outputs.....	16
2.1.3.4 Connecting the conference controller.....	17
2.1.3.5 Connecting conference units	17
2.1.3.6 Connecting an AP (only for VIS-DCP2000-W)	18
2.1.3.7 Connecting for camera tracking	18
2.1.3.8 Connecting the PC software.....	20
2.1.4 Settings and usage	21
2.1.4.1 Menu and operations	21
2.1.4.2 Setting MIC mode	28
2.1.4.3 Setting DSP	29
2.1.4.4 Setting audio zones.....	31
2.1.4.5 Setting recording	34
2.1.4.6 Setting conference unit.....	35
2.1.4.7 Setting interpreter unit.....	37
2.1.4.8 Setting camera tracking	38
2.1.4.9 Setting network address	41
2.1.4.10 Setting POE speaker.....	41
2.1.4.11 Setting system configuration	43
2.1.4.12 Setting wireless communication (only for VIS-DCP2000-W).....	44
2.1.4.13 Setting debug configuration	44
2.1.4.14 Restoring to factory settings.....	45
3. Conference units	46
3.1 VIS-DCC/DCD/DVC/DVD/DVCIC/DVDIC/DIC/DID/DSC/DSD-T units	46
3.1.1 Features and interfaces.....	46
3.1.2 Connection	50
3.1.3 Settings and usage	51
3.1.3.1 Setting unit ID	51
3.1.3.2 Setting unit types.....	52
3.1.3.3 Usage.....	53
3.2 VIS-DMD-T unit.....	55
3.2.1 Features and interfaces.....	55
3.2.2 Connection	56

3.2.3 Settings and usage	57
3.2.3.1 Setting unit ID	57
3.2.3.2 Setting unit types and rights	58
3.2.3.3 Usage.....	58
3.3 VIS-MAU-T unit.....	62
3.3.1 Features and interfaces.....	62
3.3.2 Connection	63
3.3.3 Settings and usage	64
3.3.3.1 Setting unit ID.....	64
3.3.3.2 Setting unit types and rights	65
3.3.3.3 Usage.....	65
3.4 VIS-ACC/ACD/DAC/DAD-T units.....	68
3.4.1 Features and interfaces.....	68
3.4.2 Connection	69
3.4.3 Settings and usage.....	69
3.5 VIS-DCC/DCD/CSU/DVU/SPK/FFC/FFD-F/FS/FS1/FS2/F1/F2 units	70
3.5.1 Features and interfaces.....	70
3.5.2 Installation.....	74
3.5.2.1 Hole sizes	74
3.5.2.2 Installation steps.....	75
3.5.3 Connection	75
3.5.4 Settings and usage.....	76
3.6 VIS-WDC/WDD/WVC/WVD/WVCIC/WVDIC-T units.....	77
3.6.1 Features and interfaces.....	77
3.6.2 Connection	81
3.6.3 Settings and usage.....	82
3.7 VIS-MAW-T unit	83
3.7.1 Features and interfaces.....	83
3.7.2 Connection	86
3.7.3 Settings and usage.....	86
3.7.3.1 Setting unit ID.....	86
3.7.3.2 Setting unit types and rights	87
3.7.3.3 Usage.....	87
3.7.4 Web page of charger.....	91
3.7.4.1 Connection and login	91
3.7.4.2 Web-based management.....	93
4. VIS-INT64 interpreter unit.....	96
4.1 Features and interfaces.....	96
4.2 Connection	97
4.2.1 Connected to controller.....	97
4.2.2 Connected to infrared transmitter.....	98
4.3 Settings and usage.....	99
4.3.1 Setting unit ID (only for connected to controller).....	99
4.3.2 Setting interpretation channel.....	100

4.3.3 Usage.....	100
4.3.3.1 Setting operator	100
4.3.3.2 Screen contents.....	101
5. Extension devices.....	103
5.1 VIS-EXM extension main unit.....	103
5.2 VIS-CNB splitter box.....	103
5.3 VIS-HL network cable	104
6. AP.....	105
6.1 Features and interfaces.....	105
6.2 Installation.....	105
6.2.1 Installation diagram.....	105
6.2.2 Installation precautions	106
6.3 Connection	107
6.4 Settings and usage.....	107
6.4.1 Changing the AP channel	107
6.4.1.1 Connection	107
6.4.1.2 Configuration on Web page.....	109
6.4.2 Changing the SSID and password.....	111
6.4.2.1 Changing the SSID and password of wireless conference system	111
6.4.2.2 Changing the SSID and password of AP	113
6.4.3 Restoring to factory settings.....	114
7. System connection and use case	116
7.1 System planning	116
7.2 System connection	117
7.3 Use case.....	120
8. Technical specifications	122
8.1 Camera tracking protocol	122
8.2 Devices.....	123
8.2.1 VIS-DCP2000-D	123
8.2.2 VIS-DCP2000-W	124
8.2.3 VIS-DCC/DCD/DVC/DVD/DVCIC/DVDIC/DIC/DID/DSC/DSD-T	125
8.2.4 VIS-DMD-T	125
8.2.5 VIS-MAU-T	126
8.2.6 VIS-DAC/DAD-T	127
8.2.7 VIS-DCC/DCD/CSU/DVU/SPK/FFC/FFD-F/FS/FS1/FS2/F1/F2	127
8.2.8 VIS-WDC/WDD/WVC/WVD/WVCIC/WVDIC-T	128
8.2.9 VIS-MAW-T.....	129
8.2.10 VIS-WBTY1	130
8.2.11 VIS-WCH1	130
8.2.12 VIS-WBTY2/VIS-WBTY2-H.....	130
8.2.13 VIS-WCH2.....	131
8.2.14 VIS-INT64	131
8.2.15 VIS-EXM/VIS-CNB/VIS-AP4C.....	132

1. System overview

1.1 System features

CLEACON series of full digital network DSP conference system, based on VISSONIC's self-developed AUDIO-LINK™ voice distribution and processing technology, can offer the features of discussion, voting, interpretation, sign-in, and control by computer software. The system supports audio zoning, USB voice recording and monitoring, and camera tracking. With a high-performance DSP processor that provides the audio processing algorithm, equalization technology. In addition, the system supports hand in hand loop network and hot backup of the conference controller.

The VISSONIC wireless conference system has all the features of the wired conference system previously mentioned. Besides, the wireless system uses the standard 5G WiFi technology and the WPA2-PSK (AES) encryption technology to provide a broader bandwidth with less interference, higher security and confidentiality, and easier to install, use, transfer.

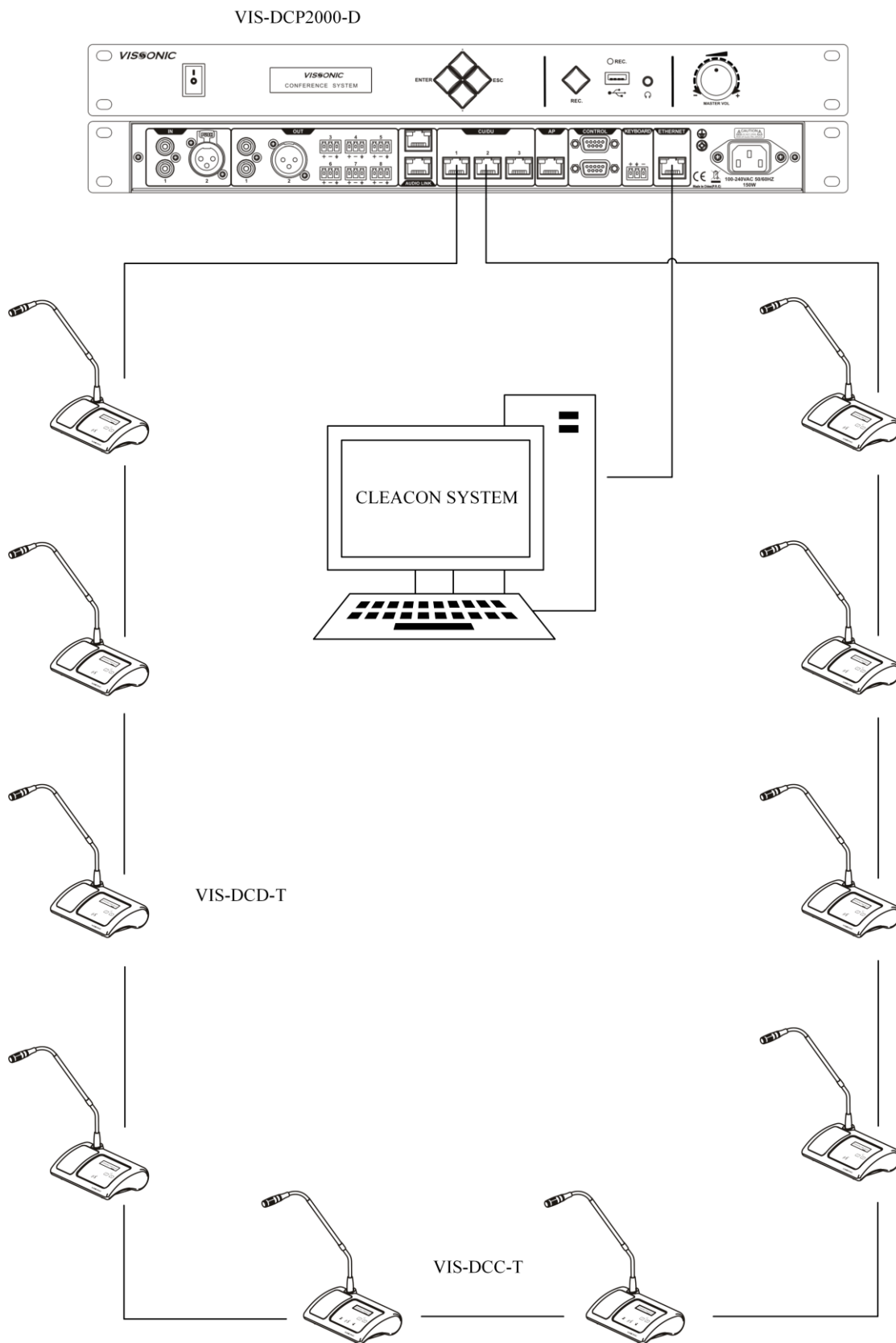

Figure 1.1.1 Wired conference system

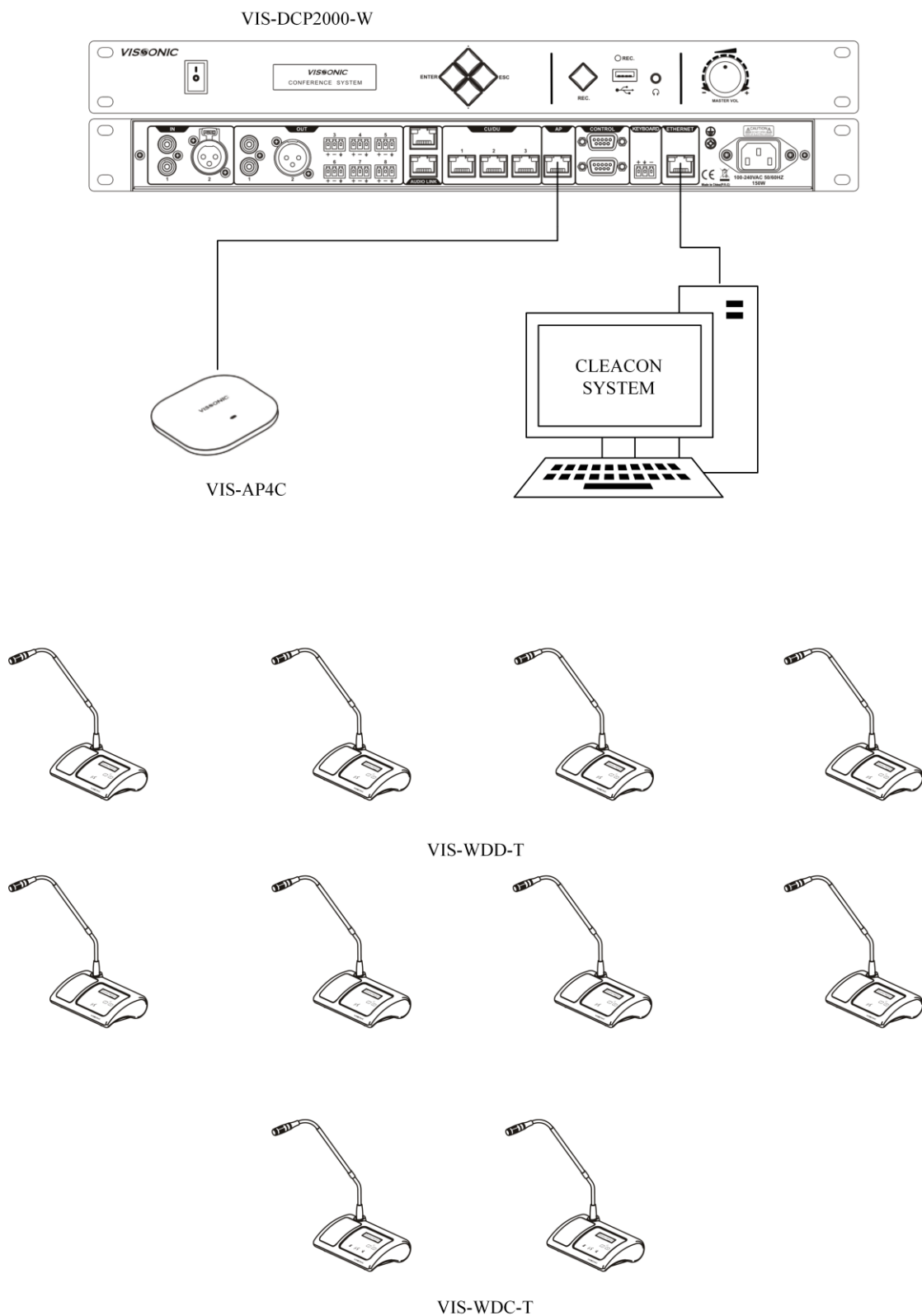

Figure 1.1.2 Wireless conference system

1.2 System composition

A basic VISSONIC wired conference system consists of a conference controller, conference units, and CAT5e cables. An extension main unit VIS-EXM can be added for connecting more conference units or increasing the communication distance. A splitter box VIS-CNB can be added for connecting an array unit. A wireless conference system contains an additional Access Point (AP) VIS-AP4C.

The conference controller, as the core in the conference system, controls all conference units independently and supplies power to these units through POE. VISSONIC conference management software can also be used on demand of more control and management features.

In the conference system, conference units are basic device used by attendees in a conference. The features, permissions, and appearance vary with the model of the conference unit. For example, the features include discussion, voting, interpretation, and sign-in. The unit provides permissions for chairman, delegate, etc. The appearance varies with different installation modes, such as desktop, array, or flush-mounting.

This manual is applicable to:

- ✓ Full Digital Wireless DSP Conference Controller VIS-DCP2000-W
- ✓ Full Digital Networked DSP Conference Controller VIS-DCP2000-D
- ✓ CAT5 Wired Digital Discussion Chairman/Delegate Unit VIS-DCC-T/VIS-DCD-T
- ✓ CAT5 Wired Digital Voting Chairman/Delegate Unit with Channel Selector VIS-DVC-T/VIS-DVD-T
- ✓ CAT5 Wired Digital Discussion+Voting IC Card Chairman/Delegate Unit with Channel Selector VIS-DVCIC-T/VIS-DVDIC-T
- ✓ CAT5 Wired Digital Interpreter Chairman/Delegate Unit VIS-DIC-T/VIS-DID-T
- ✓ CAT5 Wired Dual Channels Chairman/Delegate Unit with Channel Selector VIS-DSC-T/VIS-DSD-T
- ✓ Multimedia Digital Conference Unit with Touch Screen VIS-DMD-T
- ✓ Multimedia Wired Touch Screen Unit VIS-MAU-T
- ✓ Digital Array Microphone with Channels Selector Chairman/Delegate Unit VIS-ACC-T/VIS-ACD-T
- ✓ Digital Array Microphone Chairman/Delegate Unit VIS-DAC-T/VIS-DAD-T
- ✓ CAT5 Digital Flush-mounting Discussion Chairman/Delegate Unit VIS-DCC-F/VIS-DCD-F (all-round type) and VIS-DCC-FS/VIS-DCD-FS (economic type)
- ✓ CAT5 Digital Flush-mounting 64 Channels Selector Unit VIS-CSU-F
- ✓ CAT5 Digital Flush-mounting Voting Unit VIS-DVU-FS1 (with IC Card Reader) and VIS-DVU-FS2
- ✓ Flush-mounting Speaker Unit VIS-SPK-F
- ✓ Flush-mounting All-in-one Discussion Chairman/Delegate Unit with Voting and Channel Selector VIS-FFC-F1/VIS-FFD-F1 (simple type) and VIS-FFC-F2/VIS-FFD-F2 (big screen type)

- ✓ Wireless Digital Discussion Chairman/Delegate Unit VIS-WDC-T/VIS-WDD-T
- ✓ Wireless Digital Discussion+Voting Chairman/Delegate Unit VIS-WVC-T/VIS-WVD-T
- ✓ Wireless Digital Discussion+Voting IC Card Chairman/Delegate Unit VIS-WVCIC-T/
VIS-WVDIC-T
- ✓ 5G Wireless Multimedia Conference Unit VIS-MAW-T
- ✓ 64 Channels Interpreter Desk VIS-INT64
- ✓ Extension Main Unit VIS-EXM
- ✓ Splitter Box VIS-CNB
- ✓ 5.0 GHz Conference Access Point VIS-AP4C

2. Conference controller

2.1 VIS-DCP2000-D/W conference controller

2.1.1 Features and interfaces

VIS-DCP2000-D is a wired conference controller that supports wired Ethernet connection. This controller controls all connected conference units and supplies power to these units through POE.

VIS-DCP2000-W is a wireless conference controller that supports 5G WiFi wireless connection and wired Ethernet connection. This controller controls all connected conference units and supplies power to wired conference units through POE.

Configure whole conference system with the buttons on the front panel of the conference controller in the system.

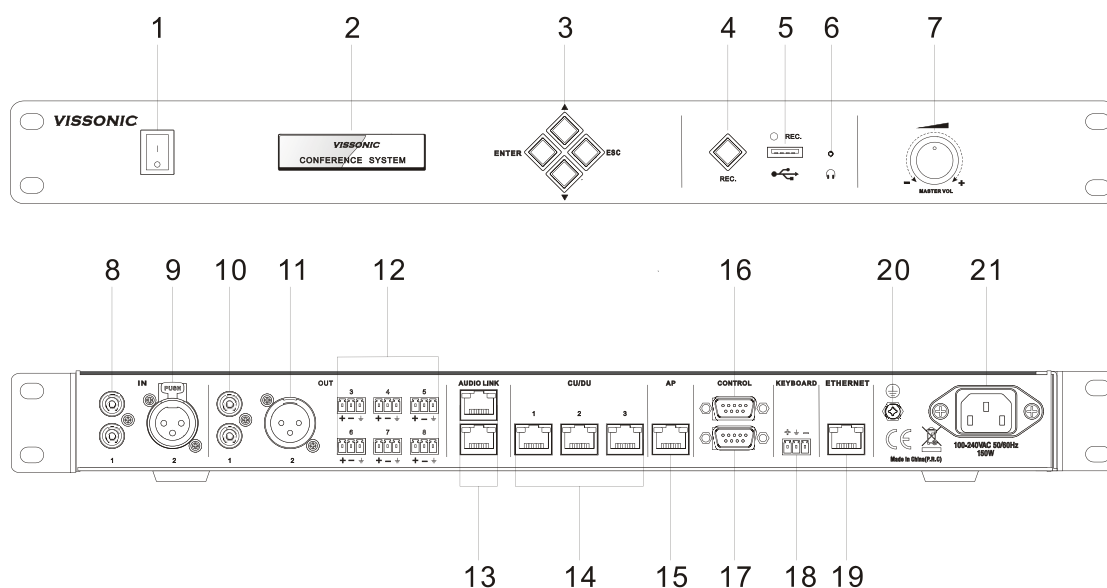



Figure 2.1.1 VIS-DCP2000-D/W front and rear panels

Front panel:

No./Name	Description
1. Power Switch	Power on or off the controller.
2. Display	Show the current status or the result of operation, menu list etc.
3. Operate Buttons	4-direction buttons for menu operation, confirm and exit.
4. Audio Recording	Press to start/stop recording the audio of whole conference content.

5. USB Slot	To insert USB disk (Up to 32G, FAT32) for recording, with status light indicator which is flashing during the recording.
6. Headphone Socket	Headphone connection.
7. Knob	Control volume level of the system.

Rear panel:

Interface	Introduction
8. Audio Inputs (IN 1)	RCA audio input from external audio sources like MP3.
9. Audio Inputs (IN 2)	<p>XLR audio input from external audio sources like Microphone and remote audio input.</p> <p> To use the AEC echo cancellation function of the controller, the audio output of the video terminal must be connected to the IN2 input port.</p>
10. Audio Outputs (OUT 1)	RCA audio output to external audio devices like PA system, loudspeakers etc. and can be set as zone 1 output.
11. Audio Outputs (OUT 2)	XLR audio output to external audio devices like Mixer, PA system etc. and can be set as zone 2 output.
12. Audio Outputs (OUT 3, OUT 4, OUT 5, OUT 6, OUT 7, OUT 8)	<p>Phoenix audio output. OUT3 and OUT4 can be set respectively as zone 3 and zone4 output. OUT4 also can be set as echo cancellation remote audio output. OUT5, OUT6, OUT7, OUT8 is corresponding to the interpretation CH1, CH2, CH3, CH4.</p> <p> OUT4 is used as audio output of the controller to the remote terminal when the AEC acoustic echo cancellation function is used.</p>
13. Audio Link	Extend to the next controller for conference room combination and audio exchange.
14. CU/DU	It is used to connect chairman unit, delegate unit, interpreter unit or POE speaker. Hand in hand loop connection can be made between port 1 and port 2 or between port 2 and port 3.
15. AP (Only available for VIS-DCP2000-W)	Connect to 5GHz Professional Conference Access Point VIS-AP4C.
16. Control	Female DP9 connector is used to connect with camera auto-tracking controller.
17. Control	Male DP9 connector is used to connect with the camera chains or third-party central controller.
18. Keyboard	Connect to the camera control keyboard.
19. Ethernet	Connect to PC or switch for the software control.
20. Ground jumper	Connect the controller to the ground.
21. Power inlet	Connect the controller to the main power supply with a power cable. 100-240V AC.

2.1.2 Installation

The conference controller can be installed in a standard 19-inch cabinet. On both sides of the front panel are standard screw holes for mounting the conference controller in the cabinet. The installation diagram is as follows.

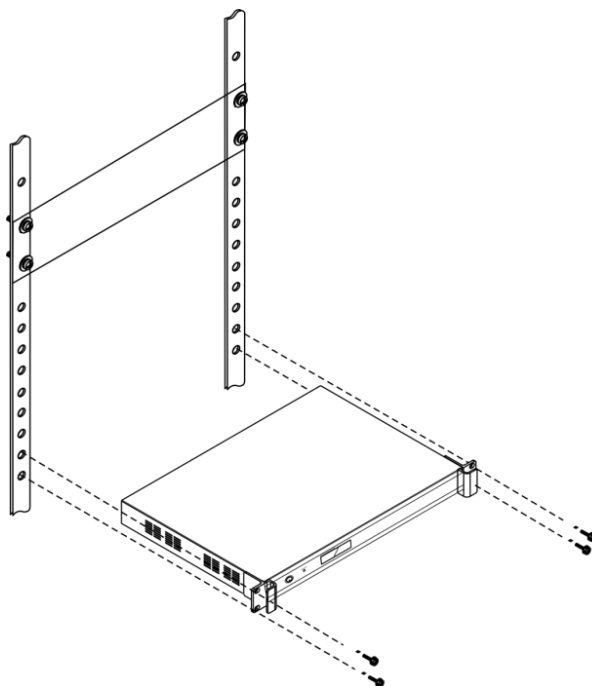

Figure 2.1.2 Mounting the conference controller

2.1.3 Connection

2.1.3.1 Connecting the power supply

Use the attached power cable to connect the conference controller to an external power socket.

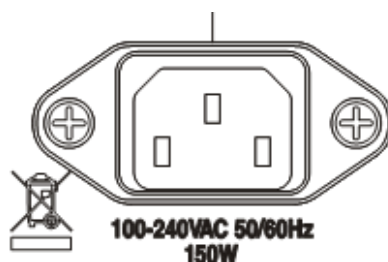

Figure 2.1.3.1 Power interface of the conference controller

Warning: The controller power supply needs to be well grounded to avoid accidents that endanger personal safety.

2.1.3.2 Connecting audio inputs

The conference controller provides two types of audio input ports, RCA and XLR. The port diagram and pin descriptions are as follows.

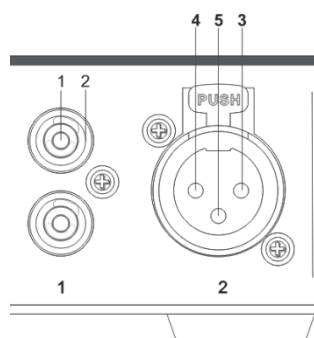

Figure 2.1.3.2 Audio input ports

Type	Pin	Signal	Description
RCA	1	Live	Signal input
	2	Return	Shield/ground
XLR	3	External	Shield/ground
	4	Live	Positive
	5	Return	Negative

2.1.3.3 Connecting audio outputs

The conference controller provides three types of audio output ports, RCA, XLR, and Phoenix. The port diagram and pin descriptions are as follows.

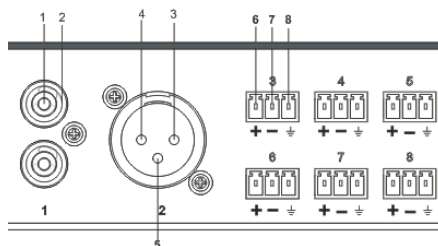

Figure 2.1.3.3 Audio output ports

Type	Pin	Signal	Description
RCA	1	Live	Signal input
	2	Return	Shield/Ground
XLR	3	External	Positive
	4	Live	Shield/Ground
	5	Return	Negative
Phoenix	6	+	Positive
	7	-	Negative
	8	G	Shield/Ground

2.1.3.4 Connecting the conference controller

The Audio Link ports of the conference controller are used for connecting other conference controllers. Conference systems can be integrated by connecting their controllers with CAT5e cable.

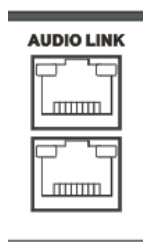

Figure 2.1.3.4 Audio link ports

2.1.3.5 Connecting conference units

The CU/DU ports of the conference controller are used to connect conference units, VIS-CNB splitter boxes, VIS-EXM extension main units, or POE speakers. VIS-CNB can be used to connect more units. VIS-EXM can be connected to increase the capacity and transmission distance. VISSONIC offers dedicated CAT5e cables for connection. You can also purchase qualified CAT5e cables.

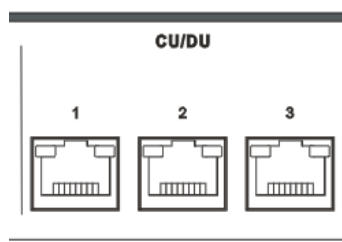

Figure 2.1.3.5 CU/DU conference unit ports

2.1.3.6 Connecting an AP (only for VIS-DCP2000-W)

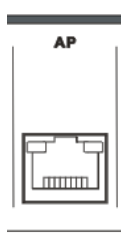

Figure 2.1.3.6 AP port

The AP port of wireless conference controller is used for connecting to VIS-AP4C 5.0 GHz AP. If multiple VIS-AP4C APs are used, connect the AP port of the conference controller to a POE switch or a VIS-CNB splitter box, through which the controller connects to the VIS-AP4C APs. Use a CAT5e cable for the connection.

Note: It's **NOT** recommended to connect other devices to the POE switch. It should connect the controller VIS-DCP2000-W and up to 8 pieces of VIS-AP4C.

2.1.3.7 Connecting for camera tracking

The CONTROL and KEYBOARD interfaces of the conference controller are used for the camera tracking feature.

1. The CONTROL interface consists of two RS232 COM ports, as shown in the following figure.

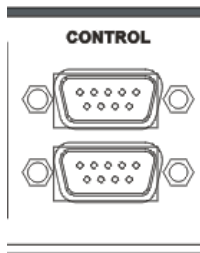

Figure 2.1.3.7.1 CONTROL interface

- The upper COM port is a female connector for connecting a VIS-CATC-A/B camera tracking controller, which is used to switch channels during camera tracking. The following table lists the default commands for channel switching. If want to customize the commands, contact us for online firmware update.

Baud rate: 9600bps, parity: 8, Stop: 1.

Command	Description
1V1.	Switch the channel 1 to output
2V1.	Switch the channel 2 to output
3V1.	Switch the channel 3 to output
4V1.	Switch the channel 4 to output
.....
14V1.	Switch the channel 14 to output
15V1.	Switch the channel 15 to output
16V1.	Switch the channel 16 to output

- The lower COM port is a male connector for connecting a camera or a third-party central controller.
- The pin descriptions of the upper and lower COM ports are as follows:

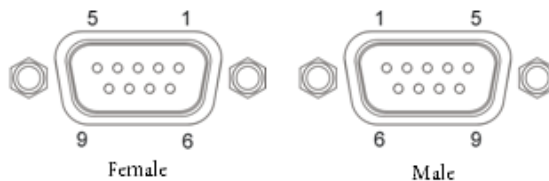

Figure 2.1.3.7.2 Pin descriptions of the CONTROL interface

Pin description of the upper COM port (DB9 female/hole)

Pin	Signal	Description
1	-	Null
2	TXD	Transmit data
3	RXD	Receive data
4	-	Null
5	GND	Signal ground

6	-	Null
7	-	Null
8	-	Null
9	-	Null

Pin descriptions of the lower COM port (DB9 male/pin)

Pin	Signal	Description
1	-	Null
2	RXD	Receive data
3	TXD	Transmit data
4	-	Null
5	GND	Signal ground
6	-	Null
7	-	Null
8	-	Null
9	-	Null

- The KEYBOARD interface is used for connecting a camera control keyboard. Use a CAT5 cable to connect this interface.

KEYBOARD



Figure 2.1.3.7.3 KEYBOARD interface

2.1.3.8 Connecting the PC software

The ETHERNET port of the conference controller can be connected to a PC directly for using the VISSONIC conference management software, or connected to a switch through which the conference controller communicates with the PC. Use a standard network cable to connect this port.

ETHERNET

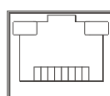

Figure 2.1.3.8 ETHERNET port

2.1.4 Settings and usage

2.1.4.1 Menu and operations

After completing the installation and connection of a conference system, use the buttons on the front panel of the conference controller to operate the menu and complete related settings on the display screen before starting a conference.

1. Turn on the conference controller. The screen displays "Initializing...". Wait for three seconds. The home screen is displayed, as shown in the following figure. The home screen shows the number of online conference units (0001-4000) connected in the system, the MIC mode (Override, Voice, Open, or Apply) of the current conference, and the maximum number of simultaneously active microphones of delegate units (For VIS-DCP2000-D, the number can be 1/2/4/6; for VIS-DCP2000-W, the number can be 1/2/4).



2. Press "ENTER" to enter the top-level menu, as shown in the following figure. Use the "▲", "▼", "ENTER", and "ESC" buttons to browse and operate the menus on different levels.



- a) Press "ENTER" to enter the next-level submenu. Press "ESC" to return to the previous-level submenu. Press "▲" or "▼" to browse submenus on the same level.
 - b) After a bottom-level parameter is displayed (as an item highlighted in green in Figure 2.1.4.1 or Figure 2.1.4.2), press "▲" or "▼" to adjust the parameter that is pointed to by the arrow, and then press "ENTER" to confirm the parameter setting.
3. The volume knob "MASTER VOL" is used to adjust the output volume. The screen displays the volume value directly. For the description of related operations, see Section 2.1.4.10.

Figure 2.1.4.1 shows the menu of VIS-DCP2000-D. Figure 2.1.4.2 shows the menu of VIS-DCP2000-W. The menu version is B4.98W.



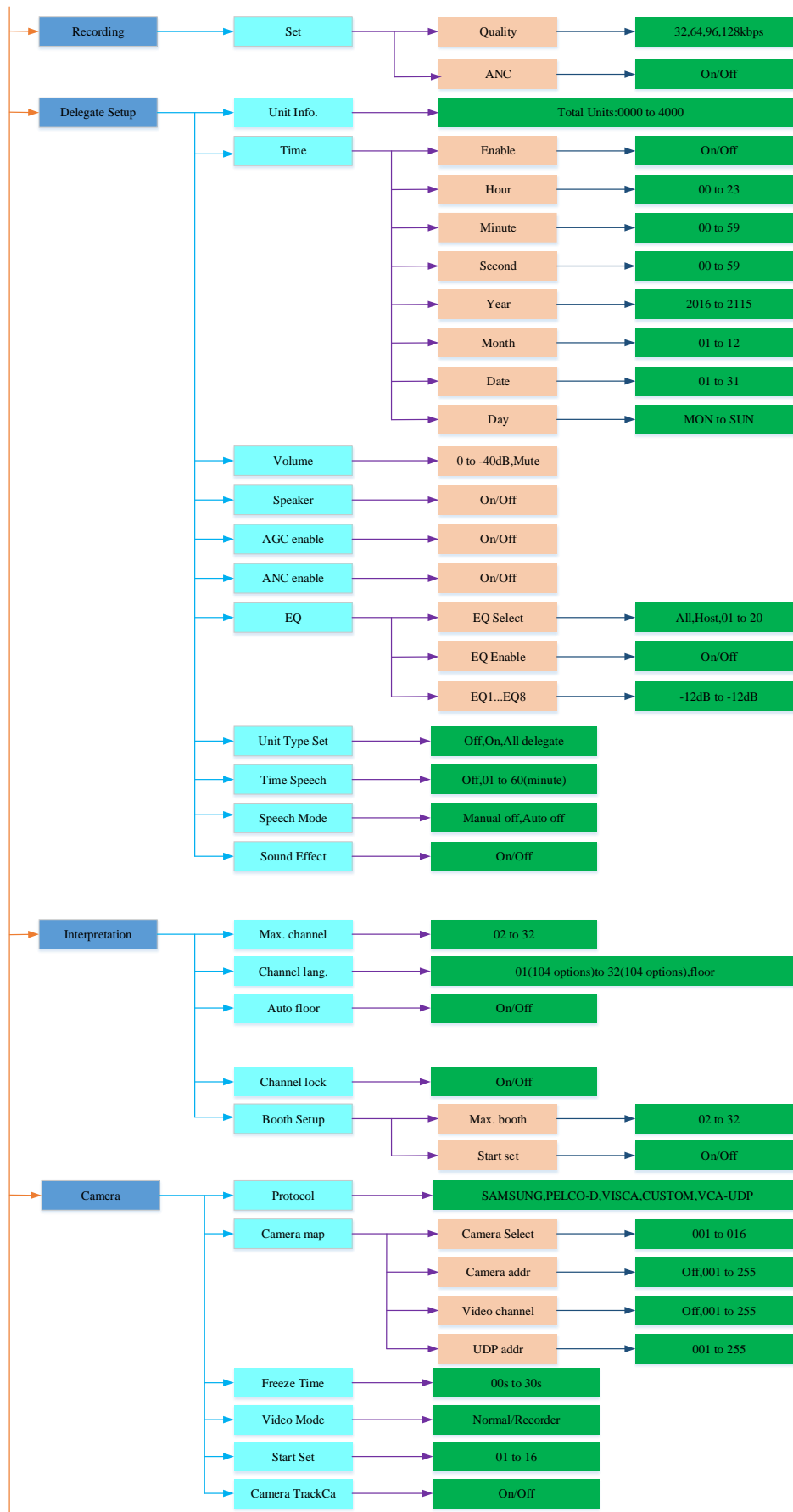

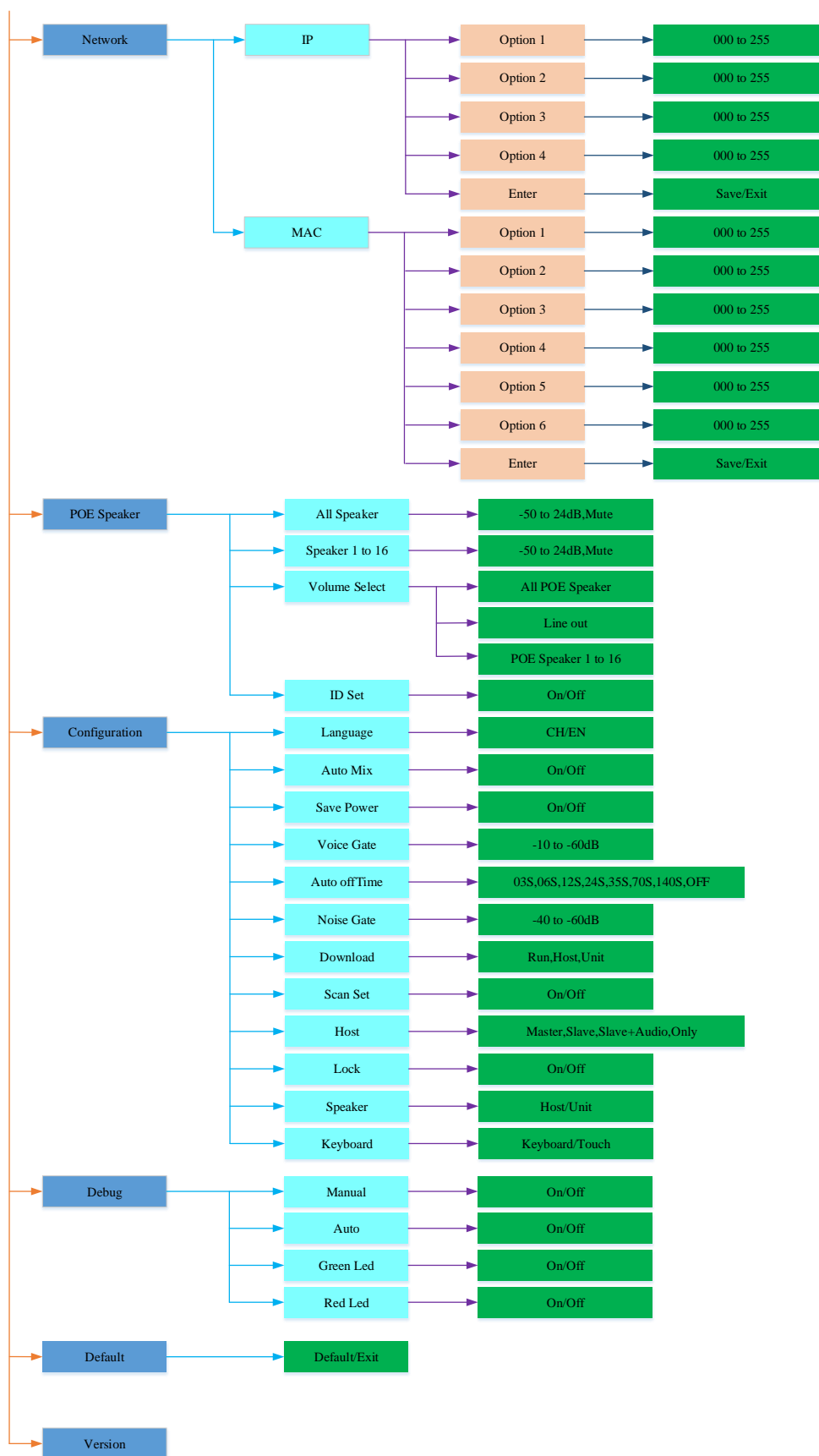
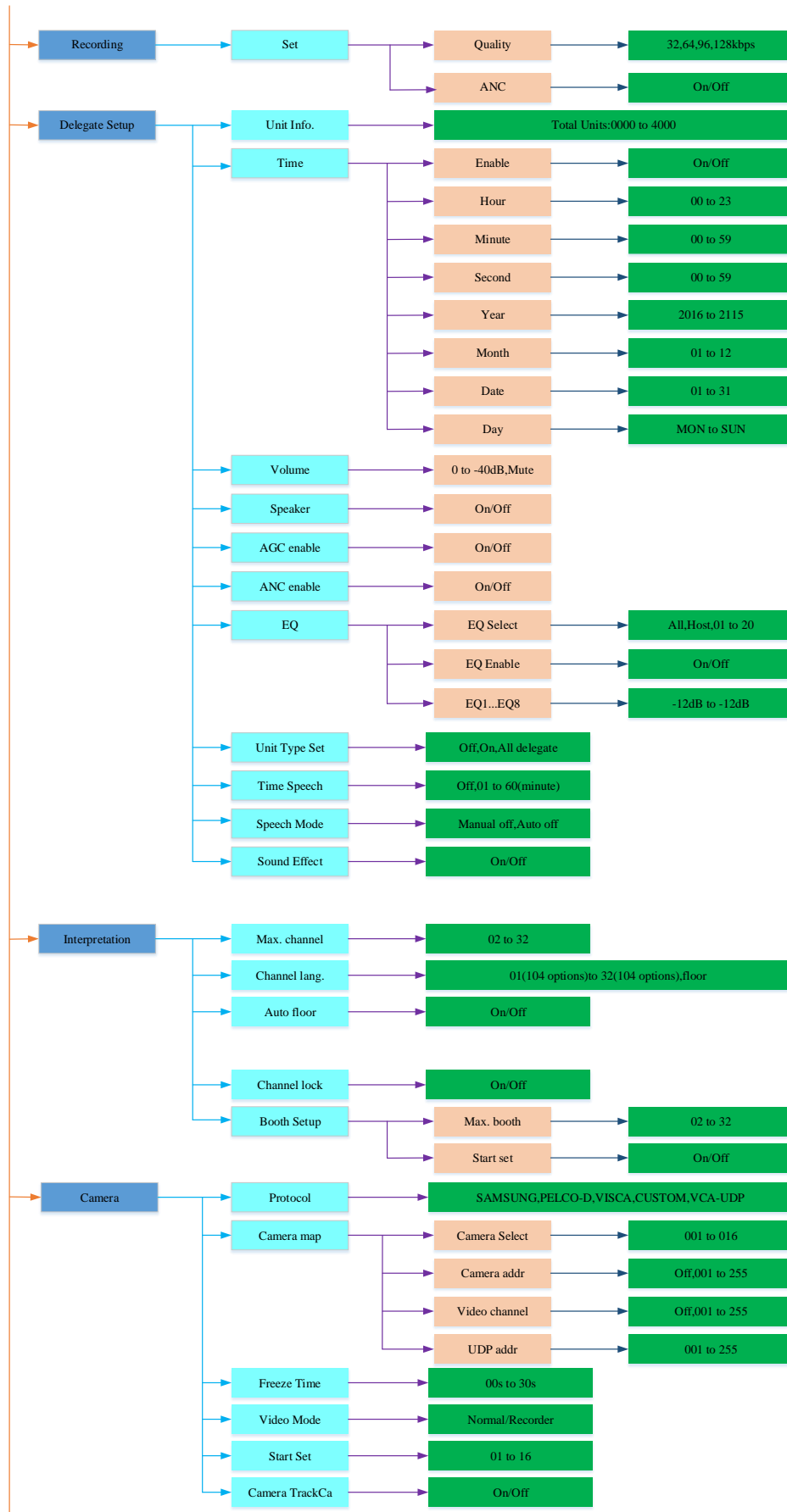

Figure 2.1.4.1 Menu of the wired conference controller





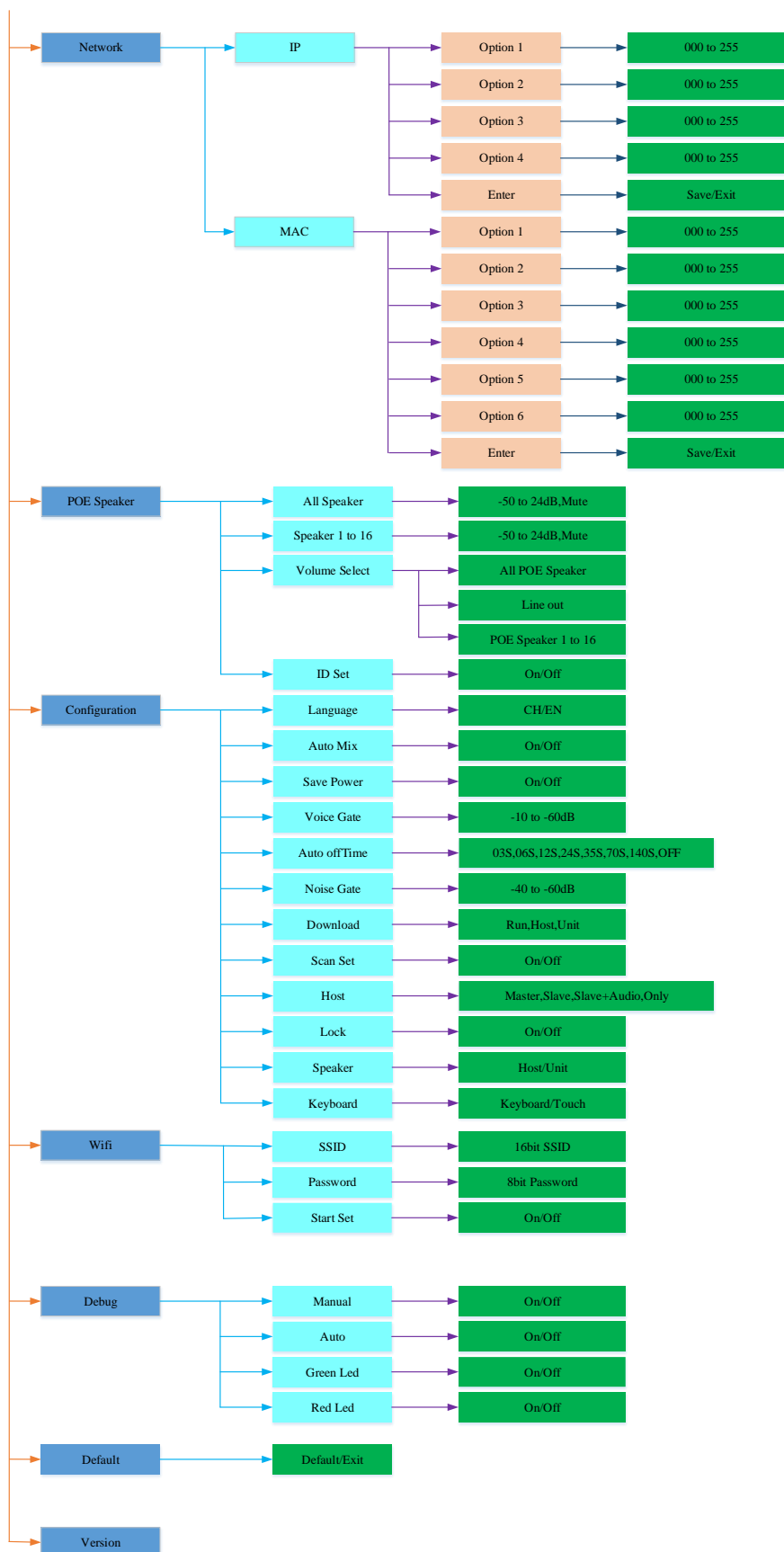

Figure 2.1.4.2 Menu of the wireless conference controller

2.1.4.2 Setting MIC mode

Enter the top-level menu on the home screen, press "▼" or "▲" to enter the setting screen of the MIC mode or the maximum number of simultaneously active microphones of delegate units. If the conference controller is connected to a PC, also can use the VISSONIC conference management software for setting.

Menu item	Parameter	Description
MIC mode	Override	In the override mode, delegates can activate their microphones with the microphone button on their units. When the maximum number of delegates speak, the next delegate that activates his or her microphone automatically deactivates the microphone that was activated for the longest time.
	Open	In the open mode, delegates can enable their microphones with the microphone button on their units. When the maximum number of delegates speaker, the next delegate that enables his or her microphone is added to a request-to-speak list. The microphone is not enable until another delegate disables his or her microphone.
	Voice	In the voice mode, the unit will be activated by the voice and no need the press the MIC button.
	Apply	In the apply mode, delegates can apply to enable their microphones with the microphone button on their units and the green LED on MIC will be on. When the chairman unit press the APROVAL button to enable the applying delegate microphone according to the applying order. When the maximum number of delegates speaker, the system allowing the same maximum number of applying microphone on the waiting list.
Active MIC	Wired controller: 1, 2, 4, 6 Wireless controller: 1,2,4.	Maximum number of simultaneously active microphones of delegate units. Note: (1) In Voice mode, the parameter value is 6, which cannot be adjusted. (2) If the parameter is set to 6 for a wired conference controller or 4 for a wireless conference controller, two chairman microphones are allowed to be activated simultaneously.

For example, to set the "Active MIC" parameter to 6, the operation is as follows:

- From the home screen, press the "ENTER" button to enter the top-level menu;



- Press the "▼" button to select the menu option "Active MIC";

```

M e n u
- > A c t i v e M I C
    
```

3. Press the "ENTER" button to enter the menu;

```

A c t i v e M I C : 1
- > 1   2   4   6
    
```

4. Press the "▼" button to select the value "6";

```

A c t i v e M I C : 1
      1   2   4 - > 6
    
```

5. Press "ENTER" to make the current value "6" take effect and display it on the first line of the current screen;

```

A c t i v e M I C : 6
      1   2   4 - > 6
    
```

6. The setting is successful, press "ESC" to return to the home screen.

```

U n i t : 0 0 0 1
M I C : O v e r r i d e / 6
    
```

2.1.4.3 Setting DSP

The "DSP" menu allows to set parameters of the audio processing algorithm. Set the parameters in the "DSP" menu to adjust the sound effect of the conference system.

Menu item	Parameter	Parameter value	Description
Enable	-	On/Off	Turn on or off the DSP sound effect processor. If the customer needs to test the original sound effect of the conference system or the processing effect of external audio equipment, the DSP processor can be turned off here.

DSP1	AFC-ANC	6dB, 12dB, 18dB, 24dB, Off	Active Noise Cancellation (ANC) up to 24dB. ANC is disabled when the parameter is set to Off. Note: 1. When audio zoning is disabled (select "Zone"→"Zone Setup"→"Enable"→"Off"), DSP1 processes the output audios of OUT1, OUT2, OUT3, and OUT4 at the same time with the same effect. 2. When audio zoning is enabled (select "Zone"→"Zone Setup"→"Enable"→"On"), DSP1 can only process one output audio among OUT1, OUT2, OUT3, and OUT4.
	AFC Enable	On/Off	Adaptive Feedforward Cancellation (AFC) is used for howling suppression. AFC is enabled when the parameter is set to On. AFC is disabled when the parameter is set to Off.
	AFC-Lever	1, 2, 3, 4, 5	AFC level, a total of 5 adjustable levels.
	AEC Enable	On/Off	Acoustic Echo Cancellation (AEC). AEC is enabled when the parameter is set to On. AEC is disabled when the parameter is set to Off. After being enabled, the AEC feature works only when the input channel IN2 is used to receive audio input from a remote terminal and the output channel OUT4 is used to send audio output to the remote terminal.
	AEC-ANC	3dB, 5dB, 7dB, 9dB, 11dB, 13dB, Off	AEC degree. No acoustic echo is canceled when this parameter is set to Off.

For example, when the DSP is turned on or off, the screen is as follows:

- Turn on DSP

Enable: On
- > On

- Turn off DSP

Enable: Off
- > Off

2.1.4.4 Setting audio zones

The "Zone" menu is used to set the audio zone and its output volume, and to select the audio channel output to the remote terminal.

The zone is off by default, and AEC of "DSP1" is also off by default (menu "DSP"→"DSP1"→"AEC Enable"→"Off"), and the OUT1, OUT2, OUT3 and OUT4 ports output the same audio. Before use the zone function, please open it (menu "Zone"→"Zone Setup"→"Enable"→"On"), and set other parameters as shown in the table below.

Menu item	Parameter	Parameter value	Description
Out 1	ID zone	X1 (1-4000)	Audios from Zone 1 are output to OUT1. ID zone: Set the ID range of units in Zone 1. The range starts from 1 by default. If set ID zone to X1 (1-4000), the unit ID in Zone 1 starts from 1 to X1.
	Zone 1 Gain	0 to -40 dB, Mute	Zone 1 Gain: Set the audio gain of unit microphones in Zone 1 to OUT1. If set Mute, no audio is sent to OUT1.
	Zone 2 Gain	0 to -40 dB, Mute	Zone 2 Gain: Set the audio gain of unit microphones in Zone 1 to OUT2. If set Mute, no audio is sent to OUT2. Default is Mute.
	Zone 3 Gain	0 to -40 dB, Mute	Zone 3 Gain: Set the audio gain of unit microphones in Zone 1 to OUT3. If set Mute, no audio is sent to OUT3. Default is Mute.
	Zone 4 Gain	0 to -40 dB, Mute	Zone 4 Gain: Set the audio gain of unit microphones in Zone 1 to OUT4. If set Mute, no audio is sent to OUT4. Default is Mute.
OUT 2	ID zone	X2 (X1+1 to 4000)	Audios from Zone 2 are output to OUT2. ID zone: Set the ID range of units in Zone 2. The range starts from X1+1 by default. If set ID zone to X2 (X1+1-4000), the unit ID in Zone 2 starts from X1+1 to X2.
	Zone 1 Gain	0 to -40 dB, Mute	Zone 1 Gain: Set the audio gain of unit microphones in Zone 2 to OUT1. If set Mute, no audio is sent to OUT1. Default is Mute.
	Zone 2 Gain	0 to -40 dB, Mute	Zone 2 Gain: Set the audio gain of unit microphones in Zone 2 to OUT2. If set Mute, no audio is sent to OUT2.
	Zone 3 Gain	0 to -40 dB, Mute	Zone 3 Gain: Set the audio gain of unit

			microphones in Zone 2 to OUT3. If set Mute, no audio is sent to OUT3. Default is Mute.
	Zone 4 Gain	0 to -40 dB, Mute	Zone 4 Gain: Set the audio gain of unit microphones in Zone 2 to OUT4. If set Mute, no audio is sent to OUT4. Default is Mute.
OUT 3	ID zone	X3 (X2+1 to 4000)	Audios from Zone 3 are output to OUT3. ID zone: Set the ID range of units in Zone 3. The range starts from X2+1 by default. If set ID zone to X3 (X2+1-4000), the unit ID in Zone 3 starts from X2+1 to X3.
	Zone 1 Gain	0 to -40 dB, Mute	Zone 1 Gain: Set the audio gain of unit microphones in Zone 3 to OUT1. If set Mute, no audio is sent to OUT1. Default is Mute.
	Zone 2 Gain	0 to -40 dB, Mute	Zone 2 Gain: Set the audio gain of unit microphones in Zone 3 to OUT2. If set Mute, no audio is sent to OUT2. Default is Mute.
	Zone 3 Gain	0 to -40 dB, Mute	Zone 3 Gain: Set the audio gain of unit microphones in Zone 3 to OUT3. If set Mute, no audio is sent to OUT3.
	Zone 4 Gain	0 to -40 dB, Mute	Zone 4 Gain: Set the audio gain of unit microphones in Zone 3 to OUT4. If set Mute, no audio is sent to OUT4. Default is Mute.
OUT 4	ID zone	X4 (X3+1 to 4000)	Audios from Zone 4 are output to OUT4. ID zone: Set the ID range of units in Zone 4. The range starts from X3+1 by default. If set ID zone to X4 (X3+1-4000), the unit ID in Zone 4 starts from X3+1 to X4.
	Zone 1 Gain	0 to -40 dB, Mute	Zone 1 Gain: Set the audio gain of unit microphones in Zone 4 to OUT1. If set Mute, no audio is sent to OUT1. Default is Mute.
	Zone 2 Gain	0 to -40 dB, Mute	Zone 2 Gain: Set the audio gain of unit microphones in Zone 4 to OUT2. If set Mute, no audio is sent to OUT2. Default is Mute.
	Zone 3 Gain	0 to -40 dB, Mute	Zone 3 Gain: Set the audio gain of unit microphones in Zone 4 to OUT3. If set Mute, no audio is sent to OUT3. Default is Mute.

	Zone 4 Gain	0 to -40 dB, Mute	Zone 4 Gain: Set the audio gain of unit microphones in Zone 4 to OUT4. If set Mute, no audio is sent to OUT4.
Zone Setup	Enable	On/Off	Turn on or off the audio zone function.
	DSP1	Off, 1, 2, 3, 4	When the audio zone function is turned On, DSP1 can choose to process one output among OUT1, OUT2, OUT3, OUT4, or choose not to process (Off).
Remote Out	-	Off, 1, 2, 3, 4	For remote audio output channel selection, it is necessary to set the Zone audio zone function to open (Menu "Zone"→"Zone Setup"→"Enable"→"on", the channel selected as the remote audio output, IN2 (Remote In) The audio of the remote input will not be mixed to this output, and multiple selections can be made. For example, if the selected values are "1" and "4", the output channels OUT1 and OUT4 will not be mixed with the input audio output of IN2. Note: DSP (menu "DSP"→"Enable") is turned on, and AEC (menu "DSP"→"DSP1"→"AEC") is also turned on, the remote output of OUT4 channel has AEC echo cancellation processing (The remote audio will also be collected by the local microphone when it is amplified locally, and needs to be processed before being transmitted to the remote terminal).

Application:

- Application 1: Change the sensitive of MICs. There are two MICs on the chairman desk, need to reduce the gain of MICs on the chairman desk. Just change the gain of zone where are MICs on the chairman desk.
- Application 2: Increase the sounding gain. There are only MICs on the rostrum, and then increase the output gain on the auditorium.

Turn on or off is displayed as follows (menu "Zone"→"Zone Setup"→"Enable"):

- Turn on zone

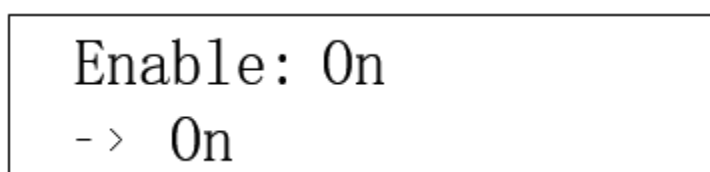

- Turn off zone

Enable: Off
- > Off

The following is an example of zone settings:

Unit IDs are used to determine the range of microphones in a zone. The range of Zone 1 starts from 1 to the configured maximum ID by default. For example, if the maximum ID in Zone 1 is set to 15, the units with IDs in the range from 1 to 15 are in Zone 1 and audios from the zone are output from OUT1 by default.

ID zone: 0015
- > 0015

1. After entering the "ID zone" menu, set the first digit to 0. The up or down button can be used to adjust the digit (0-9). Press "ENTER" to activate the second digit. An underscore cursor appears under the second digit, indicating that the digit can be set. Set the second digit to 0. Then follow the same procedure to set the third digit to 1 and the fourth to 5. After setting all digits, press "ENTER" to confirm the ID zone and then press "ESC" to exit. The range of Zone 1 is successfully set to 1-15.
2. Set a sound gain (sound volume) from Zone 1 to OUT1. The range is 0 to -40dB. If the parameter value is set to Mute, the sound from Zone 1 to OUT1 is muted.

Zone 1 Gain: 22
- > 22

3. The operations for Zone 2 are similar to those previously described. For example, if the ID zone of Zone 2 is set to 40, the range of microphones in Zone 2 is 16 to 40. Audios from Zone 2 are output to OUT2 by default.

2.1.4.5 Setting recording

The conference controller supports audio recording up to 32GB on a USB flash drive in FAT32 format. Use the submenu under the "Recording" menu to set the parameters related to recording.

Menu item	Parameter	Parameter value	Description
Set	Quality	32, 64, 96, 128 kbps	Sets the quality of sound recorded in MP3 format.
	ANC	On/Off	Enables or disables ANC for noise suppression during recording.

For example, to set 32kbps quality. Enter the menu "Recording" → "Set" → "Quality", and refer to the example in Section 2.1.4.4 for setting the value.

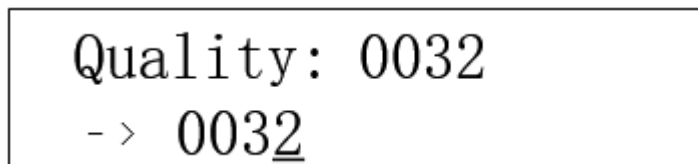

2.1.4.6 Setting conference unit

Enter the "Delegate Setup" menu to set related parameters of a conference unit.

Menu item	Parameter	Parameter value	Description
Unit Info.	Total Units	0000-4000	Show the quantity of delegate/chairman units that connected to the system and help to check the system fault.
Time	Enable	On/Off	Set the time display on the whole system, including the OLED display in the delegate unit. If set the "Enable" to off, the clock do not display on the delegate unit.
	Hour	00 to 23	
	Minute	00 to 59	
	Second	00 to 59	
	Year	2016 to 2115	
	Month	01 to 12	
	Date	01 to 31	
	Day	MON. to SUN.	
Volume	-	0 to -40 dB, Mute	Set the volume for the speaker and headphone on the delegate units.
Speaker	-	On/Off	Turn on/off the speaker on the delegate units (not include the interpreter unit).
AGC enable	-	On/Off	Automatic Gain Control (AGC) function switch.
ANC enable	-	On/Off	ANC function switch. Reduce the noise for speaker and headphone on delegate unit. (Note: Any noise reduction technology will affect the audio quality,

			if customer pursue tone quality, please set off the ANC)
EQ	EQ Select	All, Host, XXXX	Devices for which EQ needs to be set. "All" indicates all devices. "Host" indicates the conference controller. "XXXX" indicates a working conference unit with the ID XXXX (such as ID 0001 or ID 0002).
	EQ Enable	On/Off	EQ switch
	EQ1...EQ8	+12dB to -12dB	8-band EQ settings. The adjustable range of each band is from +12dB to -12dB. The default value is 00dB.
Unit Type Set	-	Off, On, All delegate	Refer to Section 3.1.3.2
Time Speech	-	01 to XX (minute), Off	Speech time of the conference unit. A countdown timer is displayed for the conference unit during the speech.
Speech mode	-	Manual off, Auto off	Method used to turn off the microphone when the speech countdown of the conference unit ends. (Custom) If the value is set to "Manual off", the microphone is automatically turned off when the speech ends. If the value is set to "Auto off", a message is displayed, prompting the conference unit to turn off the microphone manually when the speech ends.
Sound Effect	-	On/Off	Enables or disables the sound effect. (Custom)

For example, set the hour of the unit display time to 22. Enter the menu "Delegate Setup"→"Time"→"Hour", and refer to the example in Section 2.1.4.4 for setting the value.

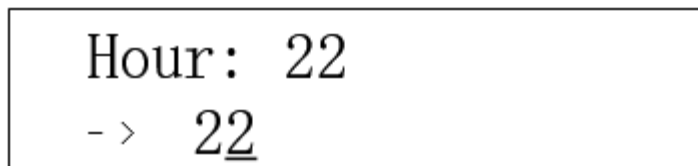

For another example, in the menu "Delegate Setup"→"Speaker", turn on/off the speaker of the delegate unit.

- Turn on the speaker of delegate unit (menu "Delegate Setup"→"Speaker"→"On"):

Enable: On
- > On

- Turn off the speaker of delegate unit (menu "Delegate Setup"→"Speaker"→"Off"):

Enable: Off
- > Off

2.1.4.7 Setting interpreter unit

Enter the "Interpretation" menu to set related parameters of an interpreter unit.

Menu item	Parameter	Parameter value	Description
Max. channel	-	02 to 32	Limit the channel number according to the need and reduce the operation on unit.
Channel lang.	00; 01; ... 32; floor	Chinese, English, ... (104 languages); Chinese, English, ... (104 languages); ... Chinese, English, ... (104 languages); floor	Binds a language to each channel. "floor" indicates the channel of original sound.
Auto floor	-	On/Off	"On" indicates that auto floor is enabled. When the microphone of the interpreter unit is turned off (interpretation stopped), the interpreter unit automatically switches the original sound to the interpretation channels for output. "Off" indicates that auto floor is disabled. When the microphone of the interpreter unit is turned off (interpretation stopped), no audio is output from the interpretation channels.

Channel lock		On/Off	On-The interpreter unit cannot be changed the output channel. Off-The interpreter unit can be changed the output channel.
Booth setup	Max. booth	02 to 32	Max. booth--set the booth quantity.
	Start set	On/Off	On--All interpreter units will show the booth number for options. Press the MIC on interpreter unit to select the booth no. The interpreter units in the same booth should be the same. Off--finish setting. Turn on the microphone of any interpreter unit, and the loudspeakers of all interpreter units in the same booth will be automatically turned off.

2.1.4.8 Setting camera tracking

Enter the "CAMERA" menu to set the camera tracking feature.

Menu item	Parameter	Parameter value	Description
Protocol	-	SAMSUNG, PELCO-D, VISCA, CUSTOM, VCA-UDP	Select a protocol for the communication between the conference controller and a camera according to the camera in use. If a third-party central controller is used, select "CUSTOM" and no longer need to set "Camera map" and "Start Set".
Camera map	Camera select	001 to 016	Camera select: Select a camera. Up to 16 cameras are supported. Camera addr: Set the address of the camera selected in "Camera select". Need to set a camera address for the SAMSUNG and PELCO-D protocols. If the selected protocol is VISCA, set the parameter to Off. Video channel: Bind the current camera address. If no video matrix switch is connected to the conference
	Camera addr	Off, 001 to 255	
	Video channel	Off, 001 to 255	

			<p>controller, set the parameter to Off.</p> <p>Note: Repeat the following operations to set the next camera: "Camera Select" → "Camera addr" → "Video channel".</p> <p>The conference controller records the parameter settings of each camera.</p>
	UDP addr	Off, 001 to 255	<p>UDP addr: Bind the IP address of a network camera. If the selected protocol is VCA-UDP, the camera IP address is required.</p>
Start Set	-	01 to 16	<p>Select the current camera (No. 01 to 16), and then set the microphone position of each unit for tracking. The steps are as follows:</p> <p>Step 1: Set the parameter to "01", which corresponds to camera 01.</p> <p>Step 2: Use the remote control to adjust the camera to track the microphone of the first unit in the camera coverage.</p> <p>Step 3: Press the on/off button of the photographed microphone.</p> <p>Step 4: Use the remote control to adjust the camera to track the microphone of the next unit in the camera coverage.</p> <p>Step 5: Press the on/off button of the photographed microphone.</p> <p>Step 6: Repeat Step 4 and Step 5 to set all microphones in the coverage of camera 01.</p> <p>Step 7: Set the parameter to "02", which corresponds to camera 02.</p> <p>Step 8: Repeat Step 2 to 6 to complete the setting of camera 02. Complete the tracking settings for all the other cameras in the same way.</p> <p>Step 9: After setting the last camera for the microphone of the last unit, adjust the camera to get a panoramic view of the conference and then press "ESC" to exit the "Start Set" menu. The panoramic view is called when the microphones of all units are turned off.</p>
Freeze Time	-	00s to 30s	<p>Delay time needed for the camera</p>

			tracking controller to switch the camera view. The delay time ranges from 0 to 30 seconds.
Video Mode	-	Normal/Recorder	Two video modes are optional. Select "Recorder" when VIS-CRS02/03/04/05B or VIS-CRS02/03/05A is used.
Camera Track	-	On/Off	Enables or disables the camera tracking feature.

The following example shows how to set two cameras when the protocol VISCA, SAMSUNG/PELCO-D, or CUSTOM is used.

1. Connect the camera (or a third-party central controller) to the lower COM port of the CONTROL interface on the conference controller.
 - Cameras using the VISCA protocol.



- Cameras using the SAMSUNG/PELCO-D protocol.



2. Connect the RS232 port of the camera tracking controller to the upper COM port of the CONTROL interface on the conference controller.
 - Connect to the VIS-CATC-A camera tracking controller through RS232.



3. If the CUSTOM protocol is used (that is, a third-party central controller is used), no longer need to set "Camera map" and "Start Set".

4. If the VISCA or SAMSUNG/PELCO-D protocol is used:
 - a) Enter the "Camera map" submenu, select a camera, set the camera address, and bind the address. For the operation details, see the description of menu parameters in this section.
 - b) Enter the "Start Set" submenu, and then use the camera remote control, keyboard, or CLEACON software to set the tracking position for each camera one by one. For the operation details, see the description of menu parameters in this section.

2.1.4.9 Setting network address

Enter the "Network" menu to set the IP address and physical address of the conference controller.

Menu item	Parameter	Parameter value	Description
IP	Option 1	000 to 255	Set the static IP for the conference controller. Default IP address:192.168.10.100 Port:10166
	Option 2	000 to 255	
	Option 3	000 to 255	
	Option 4	000 to 255	
	Enter	Save/Exit	
MAC	Option 1	000 to 255	Set the MAC address for the conference controller. Note: Under the same local area network, multiple conference controllers should be set with different MAC.
	Option 2	000 to 255	
	Option 3	000 to 255	
	Option 4	000 to 255	
	Option 5	000 to 255	
	Option 6	000 to 255	
	Enter	Save/Exit	

2.1.4.10 Setting POE speaker

Enter the "POE Speaker" menu to set the output volume of the conference controller and the volumes of POE speakers connected to the controller.

Menu item	Parameter	Parameter value	Description
ALL Speaker	-	-50 to 24dB, Mute	Set the volume of all POE speakers.
Speaker 1 to 16	-	-50 to 24dB, Mute	The volume of a speaker can be adjusted according to the ID of the POE speaker, and the volume of a

			maximum of 16 POE speakers can be adjusted.
Volume Select	All POE Speaker	-	All POE Speaker: Select this item, the knob on the front panel of the main unit will adjust the volume of the POE speaker;
	Line out	-	Line out: select this item, the knob on the front panel of the controller will adjust the output volume of the controller.
	POE Speaker 1 to 16	-	POE Speaker 1 to 16: Select a POE speaker, and adjust the speaker volume through the knob on the front panel of the controller.
ID Set		On/Off	Switch used to enable or disable the editing of POE speaker IDs. See the ID editing steps following this table.

The steps of editing a POE speaker ID are as follows:

1. Enter the "POE Speaker" submenu, set "ID Set" to "On", and then press "ESC" to return to the home screen, as shown in the following figure:

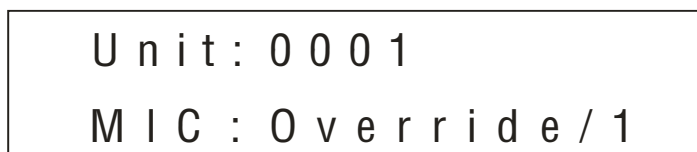

2. Long press "ESC" for about two seconds. The system enters the ID editing status. The display on the LCD screen is as follows:



3. Connect one end of a network cable to the CU/DU port of the conference controller and connect the other end to the first POE speaker. If the speaker is already connected, unplug the network cable and replug it back to the speaker. The ID of the POE speaker is successfully set to 1. Use the same method to edit the IDs of the other POE speakers one by one.
4. After editing the IDs of all POE speakers, long press "ESC" for about two seconds to return to the home screen. The setting of POE speaker IDs is complete.

2.1.4.11 Setting system configuration

Enter the "Configuration" menu to set the configuration of the conference system.

Menu item	Parameter/Value	Description
Language	CH/EN	Change the language for delegate/chairman unit (Note: We can change the language according to your need by updated the firmware).
Auto Mix	On/off	Auto MIX ON/OFF
Save power	On/Off	In the voice control mode, the volume threshold required to trigger the microphone to automatically turn on can be set.
Voice Gate	-10dB to -60dB	In the voice control mode, can set the time when the microphone is turned on and off automatically.
Auto offTime	3s, 6s, 12s, 24s, 35s, 70s, 140s	In the noise control mode, the volume threshold required to trigger the microphone to automatically turn on can be set.
Noise Gate	-40dB to -60dB	Note: Not ready, plan for system power saving.
Download	Run/Host/Unit	The default setting is "Run" to keep the system run faster. When need to update the firmware for the controller, select "Host" .When need to update the firmware for the conference units, select "Unit" (Note: Don't change the default setting "RUN", only if need to update the system.).
Scan Set	On/Off	Default is off, when scan set is on, the system will check the ID of delegate units when boot up, if there are ID conflict, those conflicting MICs will be flashing.
Host	Master, Slave, Slave+Audio, Only	If the conference system has a dual-controller hot backup architecture, select one conference controller as the primary controller (Master) and the other as the secondary controller (Slave). Allows select "Slave+Audio" to output audio from the secondary controller. For a conference system without hot backup, the parameter is set to "Only" for the conference controller by default.
Lock	On/Off	Panel lock, turn On or turn off Off; after opening, the panel button will be locked, at this time, need to long press ENTER to unlock.
Speaker	Host/Unit	Switches speakers between the controller and unit
Keyboard	Keyboard/Touch	Switches the setting method of the conference controller: by keyboard on the panel or by touch screen (custom).

2.1.4.12 Setting wireless communication (only for VIS-DCP2000-W)

Enter the "WiFi" menu to set the wireless network.

Menu item	Parameter/Value	Description
SSID	16 bits	16 bits SSID, Default setting is WIFI_CONFERENCE.
Password	8 bits	8 bits password for communication between controller to the wireless conference unit, default password is 88888888.
Start Set	On/Off	<p>Command used to start the setting, which is set to Off by default.</p> <p>If change SSID and Password on the conference controller, need to set this command to On so as to send the new SSID and Password information to APs. An update success message is displayed when an AP receives the information. Be sure to set this parameter to Off after all APs are successfully updated with the new SSID and password.</p> <p>Note: After an AP updates the SSID and password, need to restart the AP manually. The AP cannot connect to the conference controller only after log in to the VIS-AP4C AP and change the SSID and Password accordingly.</p>

2.1.4.13 Setting debug configuration

Enter the "Debug" menu to check microphones of conference units by turning on or off their microphones from the conference controller.

Menu item	Parameter/Value	Description
Manual	On/Off	<p>Turns on or off microphones of conference units manually to check whether the microphones are functioning properly.</p> <p>Set this parameter to "On" to enable the manual mode. The ID of the first conference unit is displayed on the LCD of the conference controller. The microphone of the unit is turned on. Press "▼" to switch to the second conference unit. The ID of the second unit is displayed and the second microphone is turned on. The microphone of the first</p>

		unit is turned off at the same time. Press "▼" to check all connected conference units one by one until "End Of Test" is displayed. All microphones are turned off at the end of the test. Press "ESC" to exit the manual mode. The parameter turns back into "Off" automatically.
Auto	On/Off	Turns on or off microphones of conference units automatically to check whether the microphones are functioning properly. The automatic mode is similar to the manual mode. The difference is that in the automatic mode, the conference controller automatically switches to the microphone of the next conference unit every four seconds until "End Of Test" is displayed. Press "ESC" to exit the automatic mode. The parameter turns back into "Off" automatically.
Green Led	On/Off	Turns on or off the green LED ring on the microphone of a conference unit.
Red Led	On/Off	Turns on or off the red LED ring on the microphone of a conference unit.

2.1.4.14 Restoring to factory settings

If an emergency occurs or parameters are improperly configured, you can enter the "Default" menu to restore the conference controller to factory settings.

Menu item	Parameter/Value	Description
Default	Default/Exit	Restores to factory settings or exits.

3. Conference units

3.1 VIS-DCC/DCD/DVC/DVD/DVCIC/DVDIC/DIC/DID

/DSC/DSD-T units

3.1.1 Features and interfaces

The conference units in this series are desktop wired digital units that use CAT5e cables for communication. The product models and features are as follows:

- ✓ CAT5 Wired Digital Discussion Chairman/Delegate Unit VIS-DCC-T/VIS-DCD-T
- ✓ CAT5 Wired Digital Voting Chairman/Delegate Unit with Channel Selector VIS-DVC-T/VIS-DVD-T
- ✓ CAT5 Wired Digital Discussion+Voting IC Card Chairman/Delegate Unit with Channel Selector VIS-DVCIC-T/VIS-DVDIC-T
- ✓ CAT5 Wired Digital Interpreter Chairman/Delegate Unit VIS-DIC-T/VIS-DID-T
- ✓ CAT5 Wired Dual Channels Chairman/Delegate Unit with Channel Selector VIS-DSC-T/VIS-DSD-T

VIS-DCD-T

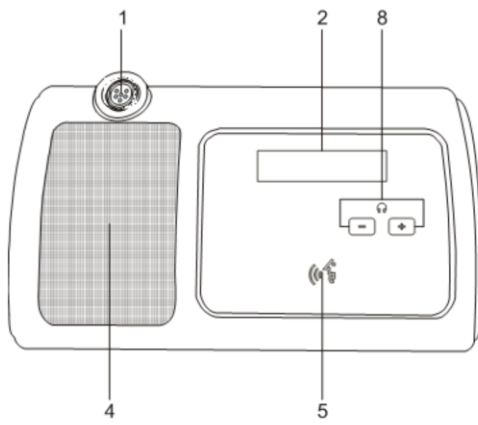

VIS-DCC-T

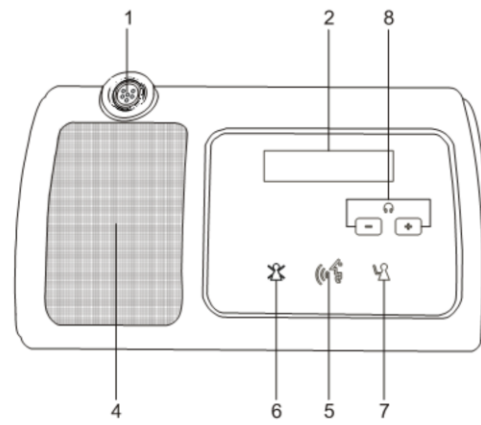

VIS-DVD-T/VIS-DVDIC-T

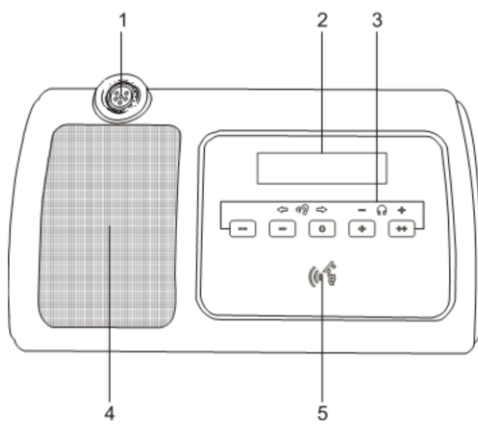

VIS-DVC-T/VIS-DVCIC-T

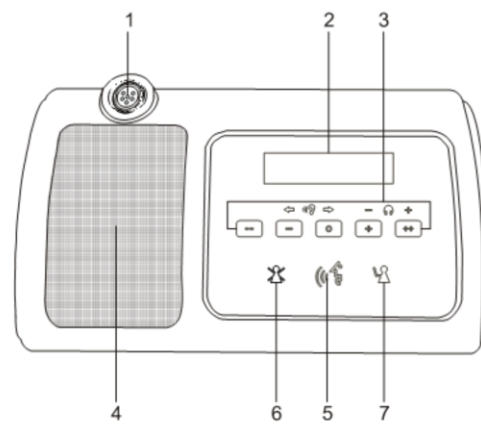

Figure 3.1.1.1 Top view of wired units VIS-DCC/DCC/DVC/DVD/DVCIC/DVDIC-T

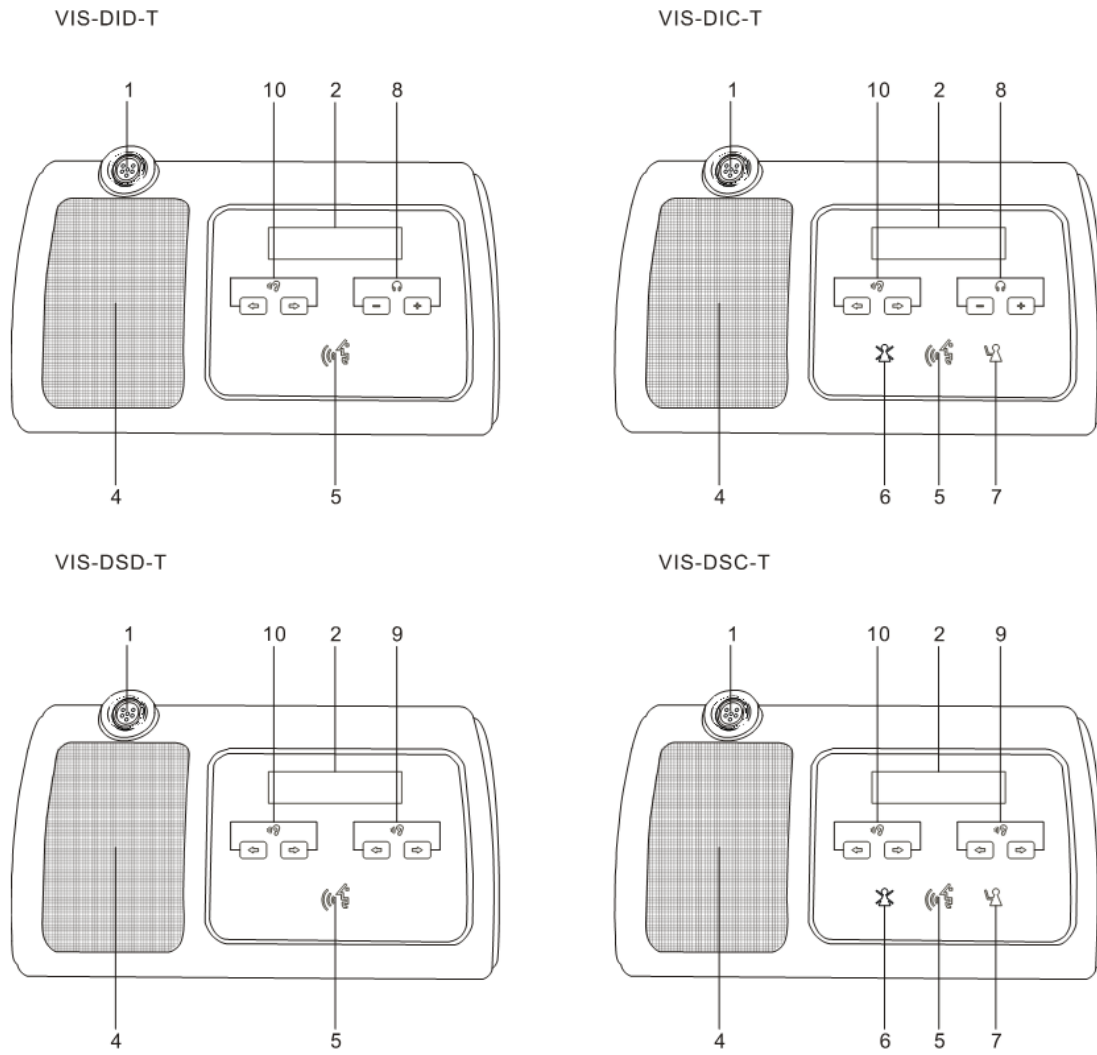

Figure 3.1.1.2 Top view of wired units VIS-DIC/DID/DSC/DSD-T

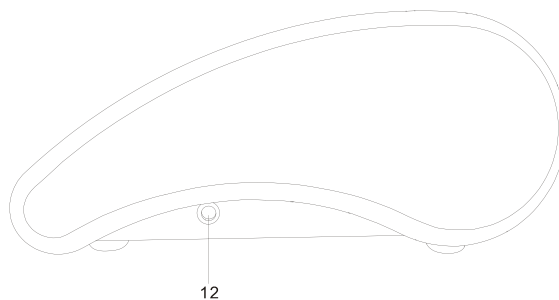
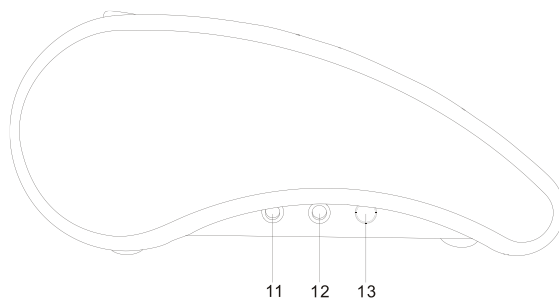

Figure 3.1.1.3 Left view and right view of wired units



Figure 3.1.1.4 Rear view of wired units

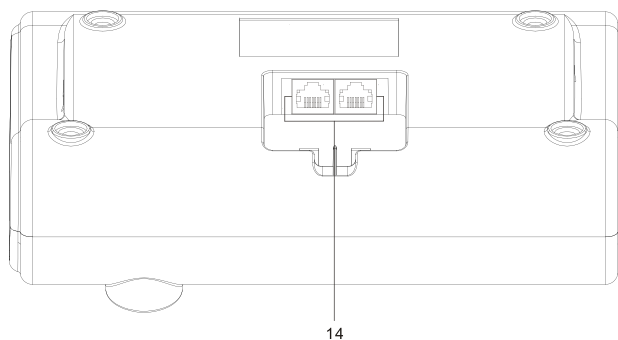

Figure 3.1.1.5 Interfaces on the bottom of a wired unit

No./Name	Description
1. Microphone socket	Connects a pluggable gooseneck microphone (VIS-M600, VIS-M410 or VIS-M330).
2. OLED display	Display the MIC status, volume bar, interpretation channel, voting information, speaking time, clock and date.

3. 5 multi-function buttons	Apply the voting, volume adjustment for headphones, channel selector to select the channel that is sent to the headphone.
4. Loudspeaker	When the microphone is enabled, the signal of the loudspeaker is muted.
5. Microphone button	Turn on or off the microphone. The microphone button has a LED that shows the condition of the microphone.
6. Clear button	Clear/deactivate all active delegate microphone or mute the system.
7. Approval button	Approve the applying microphone to be enabled under the apply mode and work as mute while pressed clear button.
8. Volume button	Adjust the headphone volume.
9. Right channel selector	Selects the channel that is sent to the right headphones.
10. Left channels selector	Selects the channel that is sent to the left headphones.
11. Reserved custom interface	This interface can be customized for connecting a mobile phone or handheld microphone, or inputting another sound source from the conference unit to the conference system.
12. Headphone socket	Standard 3.5mm headphone connector.
13. Power switch	Power switch for the conference unit.
14. CU/DU socket	Makes a loop-through in the CEALCON system with the conference unit.

3.1.2 Connection

CU/DU ports on the bottom of the conference unit are used for connecting another conference unit, a conference controller, an extension main unit, or a splitter box. The ports support the hand-in-hand-loop-network connection of units.

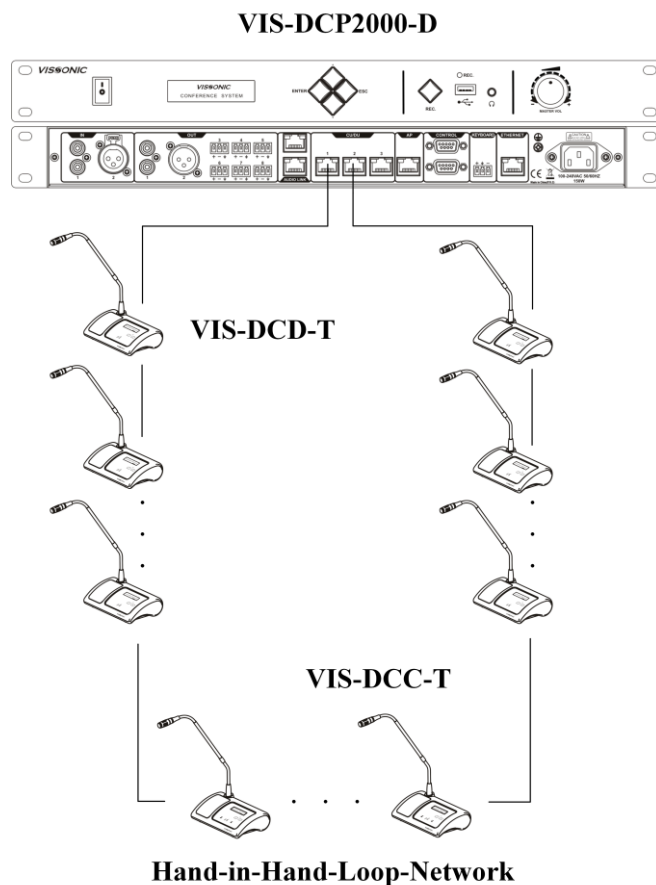

3.1.3 Settings and usage

After the connection of all units, need to set the **ID** of each conference unit before using the conference system for the first time. (If replace a unit with a new one or add a new unit, be sure to reset the new unit ID to prevent ID conflicts.)

If a VIS-DIC-T unit is installed, need to configure the unit as a chairman unit, delegate unit, interpreter unit, or VIP unit as required by the conference.

VIS-DVCIC/DVDIC-T has IC card sign-in function more than unit VIS-DVC/DVD-T (need to be set on PC software).

3.1.3.1 Setting unit ID

1. When the home screen is displayed on the LCD of the conference controller, as shown in the following figure:

```

Unit: 0001
MIC: Override / 1
    
```

2. Long press "ESC" on the front panel of the conference controller for about two seconds. The system enters the ID editing status. The display on the LCD screen is as follows:

```

Setting ID . . .
    
```

3. Press the MIC button of each conference unit one by one. (The button turns into red.) Each unit is assigned with an ID.number. (The ID number starts from 1 by default and increases by one every time the MIC button of a unit is pressed.) During the ID setting of a unit, a local ID (ID before setting) and a current ID (ID after setting) are displayed.
4. After pressing the MIC buttons of all units, long press "ESC" on the front panel of the conference controller for about two seconds to return to the home screen. The ID setting is complete.

Note: Unit IDs must be different. Units with the same ID may be turned on and off at the same time due to ID conflict. In addition, the corresponding microphones may buzz after being turned on or fail to output audio. If such issues occur, need to reset the units with different IDs.

3.1.3.2 Setting unit types

The VIS-DIC-T unit can set the unit type as required.

1. Enter the menu of "Delegate Setup" and set on the sub-menu "Unit Type Set".

```

Delegate Setup:
Unit Type Set
    
```

2. VIS-DIC-T is default as the chairman unit and there are most of units are delegate units in a conference system, so need to set all units as "All delegates".

```

Type: All del.
-> All delegates
    
```

- Set as the above screen, all the VIS-DIC-T are worked as the delegate units. Next set the as "Type: ON".

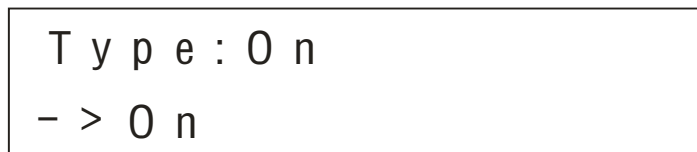

- Check all VIS-DIC-T conference units, the display shows "delegate" unit;

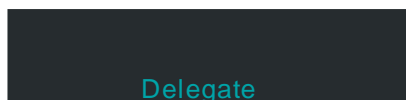

- Press the MIC button on the unit and the display will shift cyclically as Delegate-Chairman-Interpreter-VIP. The unit type can be set according to the needs of the meeting;

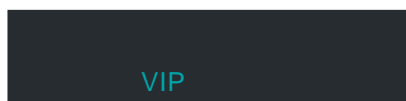
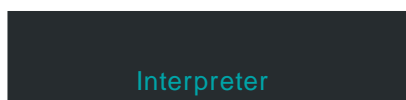

- After setting the unit type for all units, close the manual setting state as shown in the figure below, and then restart the controller to complete the setting.



3.1.3.3 Usage





- Chairman/delegate unit

The colors of the LEDs of the microphone buttons, the LED ring of MIC and display show the condition of the microphone that connected to the conference unit. See Section 3.1.1 for other buttons.

MIC button color	LED ring color	Display character	Condition
Red (on)	Red (on)	Mic on	Microphone enabled
White (off)	Green (on)	Applying to speak	Request to speak

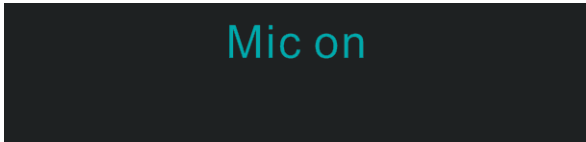
		Please wait...	
--	--	----------------	--

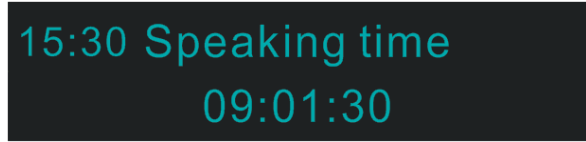
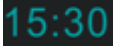
2. VIS-DIC-T

Screen	Description
	<p>Main screen.</p> <p>"Interpreter unit": Unit type.</p> <p>"Out:01 ENG": show the interpreter unit output to channel number and language name. Press the channel buttons   to change the output channel.</p> <p>Volume bar to show the volume level to speaker and headphone and press the volume buttons   to adjust it.</p>
 	<p>Press the MIC button  to turn on/off the microphone.</p>
	<p>Show the speaking time.</p> <p> Digital clock show the current time.</p>
	<p>Press the button  and hold for mute for cough, release the button to unmute.</p>

3.2 VIS-DMD-T unit

3.2.1 Features and interfaces

VIS-DMD-T is a wired multimedia digital conference unit with a 5.0-inch (800×480) touch screen. This unit uses CAT5e cables for communication. The unit can be set as a chairman unit, delegate unit, VIP unit, or a dual-user unit according to the actual requirements of a conference. By updating the unit software, the unit can offer more features with the same hardware.

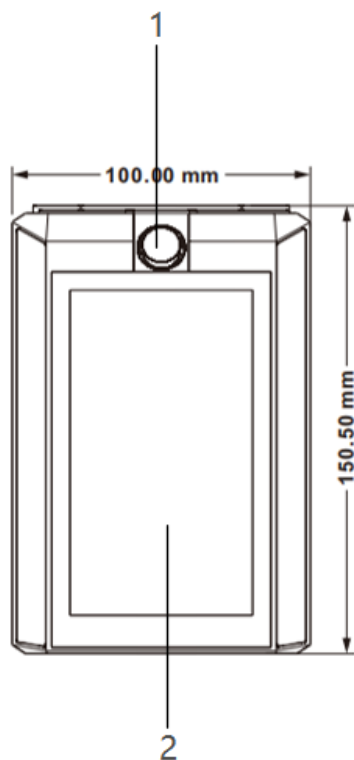

VIS-DMD-T

Figure 3.2.1.1 Top view of VIS-DMD-T

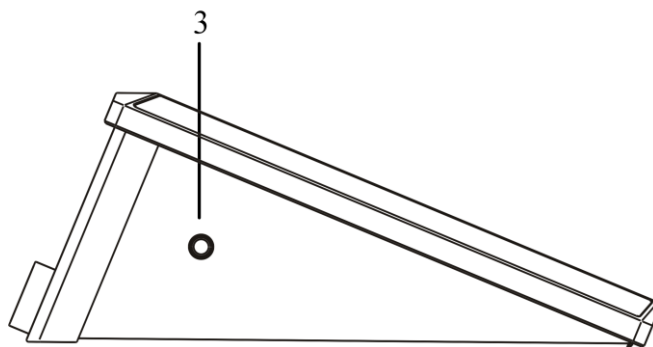

Figure 3.2.1.2 Left view of VIS-DMD-T

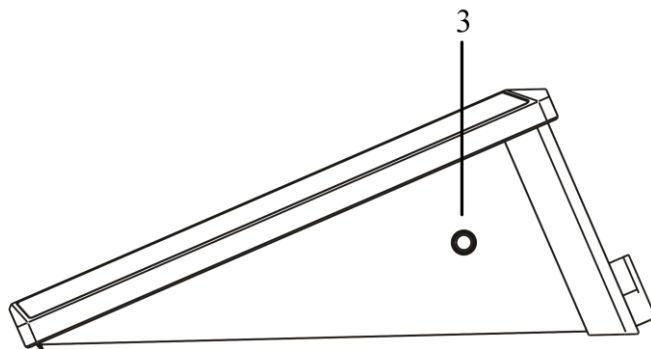

Figure 3.2.1.3 Right view of VIS-DMD-T

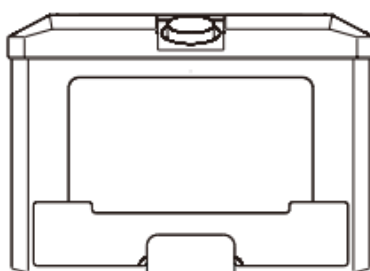
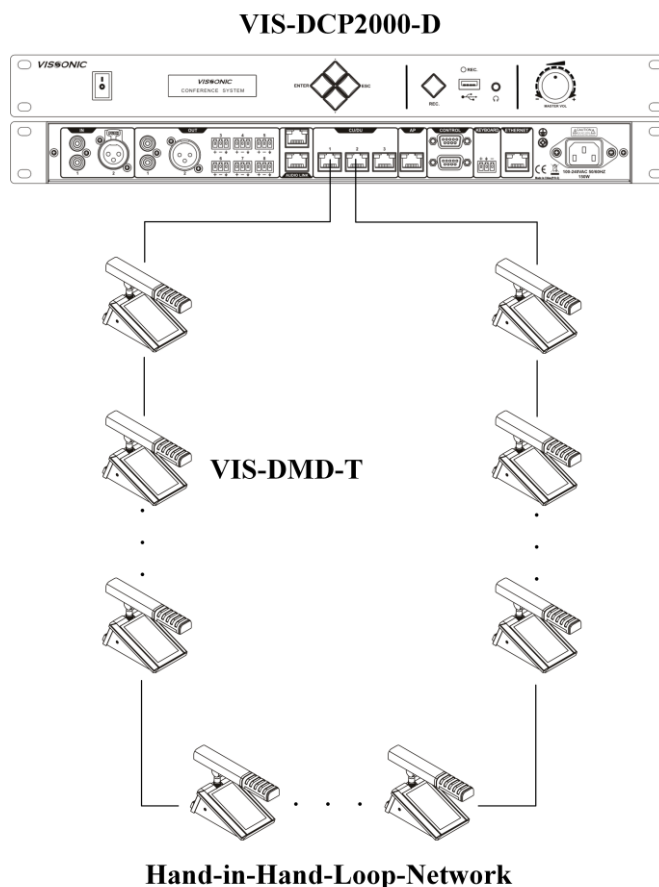

Figure 3.2.1.4 Rear view of VIS-DMD-T

No./Name	Description
1. Microphone socket	Connects a pluggable gooseneck microphone (VIS-M600, VIS-M410 or VIS-M330).
2. OLED display	Display the MIC status, volume bar, interpretation channel, voting information, speaking time, clock and date.
3. Headphone socket	Standard 3.5mm headphone connector.

3.2.2 Connection

CU/DU ports on the bottom of the conference unit are used for connecting another conference unit, a conference controller, an extension main unit, or a splitter box. The ports support the hand-in-hand-loop-network connection of units.



3.2.3 Settings and usage

3.2.3.1 Setting unit ID

After the connection of all units, need to set the ID of each conference unit before first time using the conference system (If replace a unit with a new one or add a new unit, be sure to reset the new unit ID to prevent ID conflicts.), refer to Section 3.1.3.1.

During the setting process, the unit will display the local ID (ID before setting) and the current ID (ID after setting) as shown in the figure below.

Note: Unit IDs must be different. Units with the same ID may be turned on and off at the same time due to ID conflict. In addition, the corresponding microphones may buzz after being turned on or fail to output audio. If such issues occur, need to reset the units with different IDs.

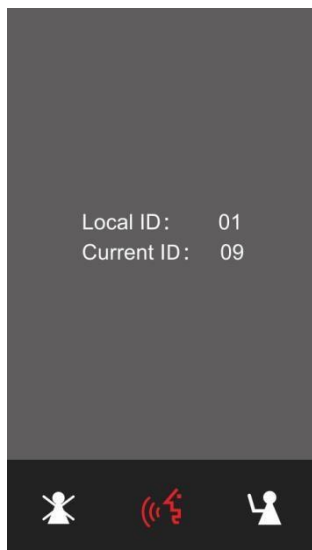

3.2.3.2 Setting unit types and rights

- Please refer to Section 3.1.3.2 for unit type setting. The unit type is displayed in the menu  → "About" → "Type".
- Use VISSONIC conference management software to set unit rights. In the management mode, right-click the unit icon and select personnel rights. Then set the unit rights, such as ID, speaking, voting, and sign-in.

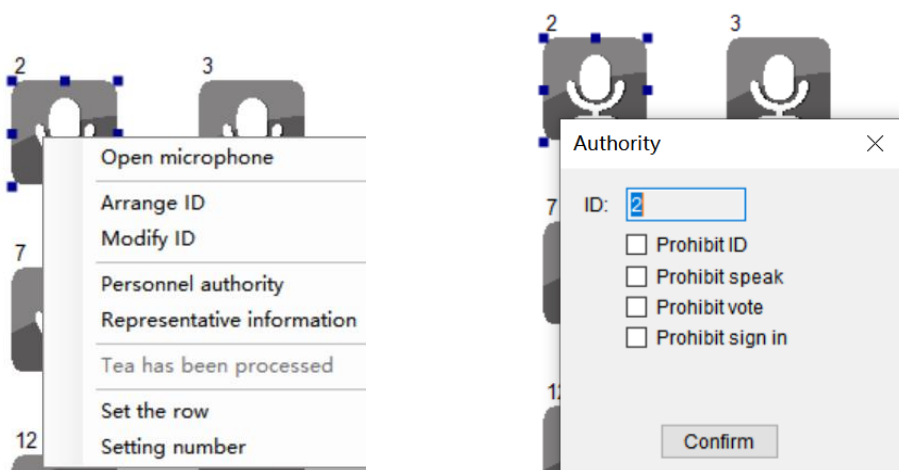



3.2.3.3 Usage

- The colors of the LEDs of the microphone buttons, the LED ring of MIC and display show

the condition of the microphone that connected to the conference unit.

MIC button color	LED ring color	Display character	Condition
Red (on)	Red (on)	Mic on	Microphone enabled
White (off)	Green (on)	Applying to speak Please wait...	Request to speak

- The unit has a concise and attractive appearance with a home screen displaying the following information: dual channel selectors that can be used by two users, both digital time and dial time, as well as the date. Tap the left setting button  to enter the unit feature setting screen or tap the right interpretation button  to enter the interpretation channel setting screen.



- Tap the setting button  to enter the settings menu. Then can set the unit language, screen brightness, sound effect, unit information, voting feature, and call service.

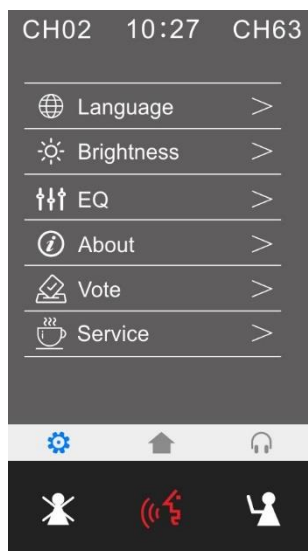

- Speech time and request to speak: After touch the microphone turn-on button, the screen displays the speech time of attendees in real time. After turn off the microphone, the screen

displays the addresser information and the information of addressers in the request list. A chairman unit has the right to turn off the microphone of the addresser's delegate unit and the right to accept or reject the request to speak from a delegate unit. Need to set corresponding user information of conference units in the VISSONIC conference management software.



- Language and brightness: In the unit settings, the system allows to switch the unit language between Chinese and English. Language customization is available if a third language is required. You can also adjust the screen brightness as needed.

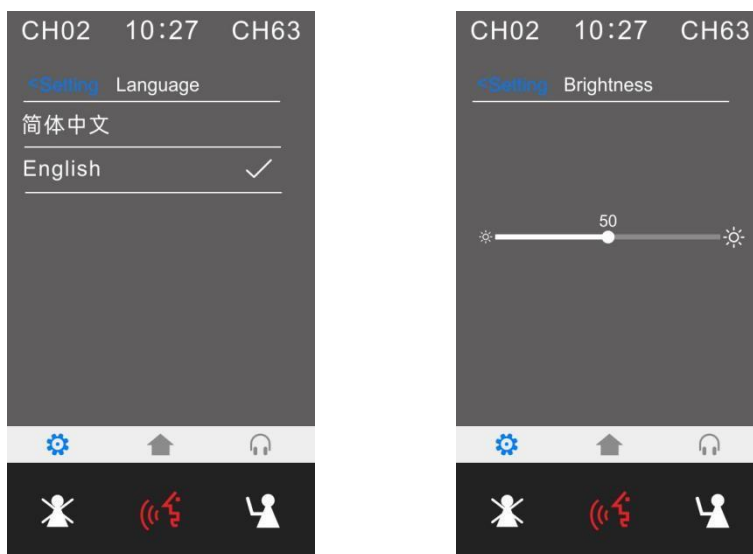

- The "Sound effect" setting provides 8-band EQ adjustment, EQ switch, EQ reset; and provides ± 12 dB microphone sensitivity adjustment (although increasing the microphone sensitivity makes it easier to pick up small voices, it also makes it easier to pick up small noises and overload distortion, so please adjust carefully). In "About" settings, can view the unit authority and status information, including the unit type, current ID number, vote authority, speaking authority, and software version.



- Call service: The system provides a call service that can be customized for paper, pen, or tea service with one tap. The VIS-DMT-T conference management software can receive calls from conference units. The call service feature provides comfortable and fast services during conference.

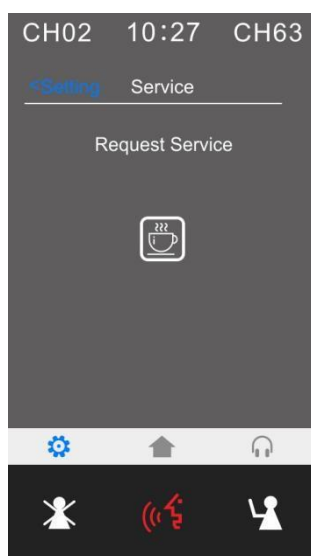

- The optional features are as follows. For more details, see *VISSONIC Multimedia Digital Conference Unit VIS-DMD-T User Manual V2.0*.
 - ▶ IC card sign-in and information display function (software license model: VIS-LIDEN)
 - ▶ Voting function (software license model: VIS-LVOTE)
 - ▶ Dual 64-channel selector software module (software license model: VIS-LLGE)
 - ▶ Dual-user software (software license model: VIS-LDUAL)

3.3 VIS-MAU-T unit

3.3.1 Features and interfaces

VIS-MAU-T is a wired multimedia conference unit with a 4.3-inch (800×480) touch screen. This conference unit supports wired network communication through a CAT5e cable.

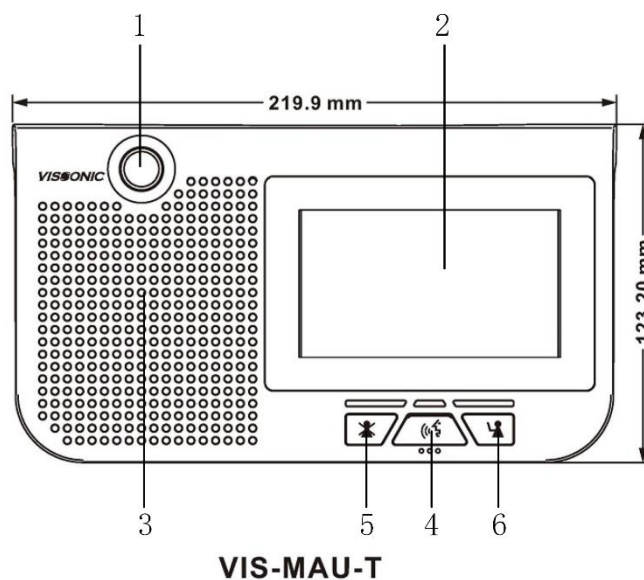

Figure 3.3.1.1 Top view of VIS-MAU-T

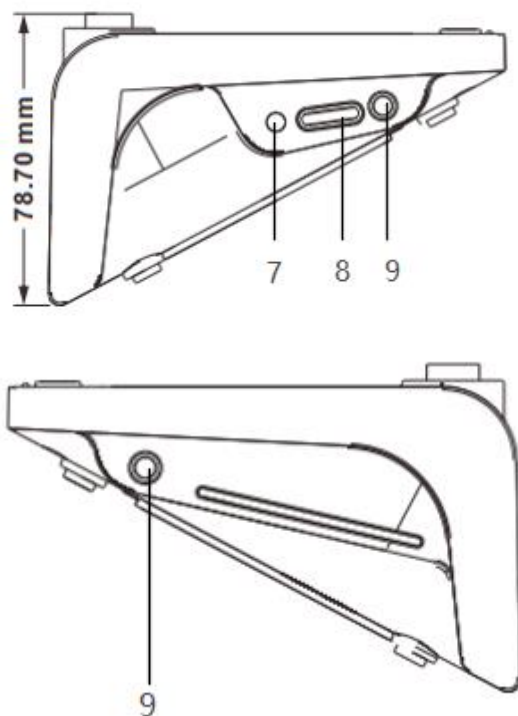

Figure 3.3.1.2 Left view and right view of VIS-MAU-T

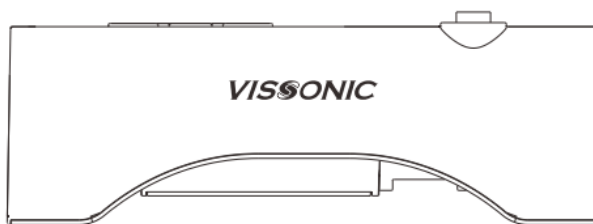

Figure 3.3.1.3 Rear view of VIS-MAU-T

No./Name	Description
1. Microphone socket	Connects a pluggable gooseneck microphone (VIS-M600, VIS-M410 or VIS-M330).
2. OLED display	Display the MIC status, volume bar, interpretation channel, voting information, speaking time, clock and date.
3. Loudspeaker	When the microphone is enabled, the signal of the loudspeaker is muted.
4. Microphone button	Turn on or off the microphone. The microphone button has a LED that shows the condition of the microphone.
5. Clear button	Clear/deactivate all active delegate microphone or mute the system.
6. Approval button	Approve the applying microphone to be enabled under the apply mode and work as mute while pressed clear button.
7. Power switch	Power switch for the conference unit.
8. Headphone Volume Knob	Adjust the headphone volume.
9. Headphone socket	Standard 3.5mm headphone connector.

3.3.2 Connection

CU/DU ports on the bottom of the conference unit are used for connecting another conference unit, a conference controller, an extension main unit, or a splitter box. The ports support the hand-in-hand-loop-network connection of units.

VIS-DCP2000-D

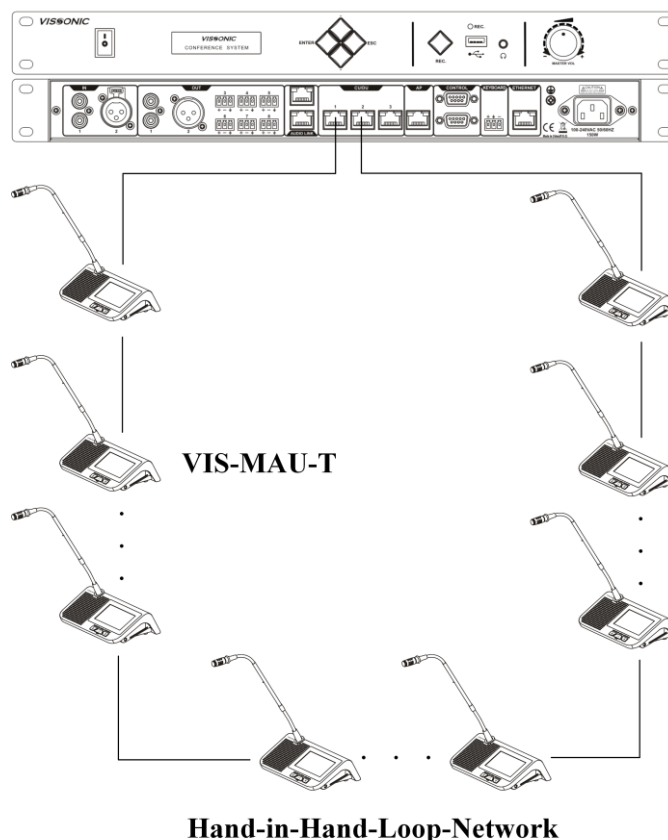

3.3.3 Settings and usage

3.3.3.1 Setting unit ID

After the connection of all units, need to set the ID of each conference unit before first time using the conference system (If replace a unit with a new one or add a new unit, be sure to reset the new unit ID to prevent ID conflicts.), refer to Section 3.1.3.1.

During the setting process, the unit will display the local ID (ID before setting) and the current ID (ID after setting) as shown in the figure below.

Note: Unit IDs must be different. Units with the same ID may be turned on and off at the same time due to ID conflict. In addition, the corresponding microphones may buzz after being turned on or fail to output audio. If such issues occur, need to reset the units with different IDs.

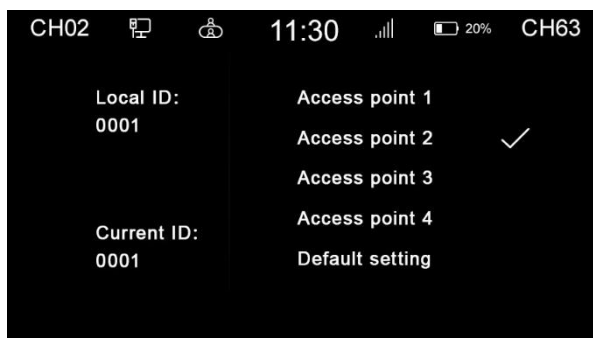

3.3.3.2 Setting unit types and rights

- Please refer to Section 3.1.3.2 for unit type setting. The unit type is displayed in the menu  → "About" → "Type".
- Use VISSONIC conference management software to set unit rights. In the management mode, right-click the unit icon and select personnel rights. Then set the unit rights, such as ID, speaking, voting, and sign-in.

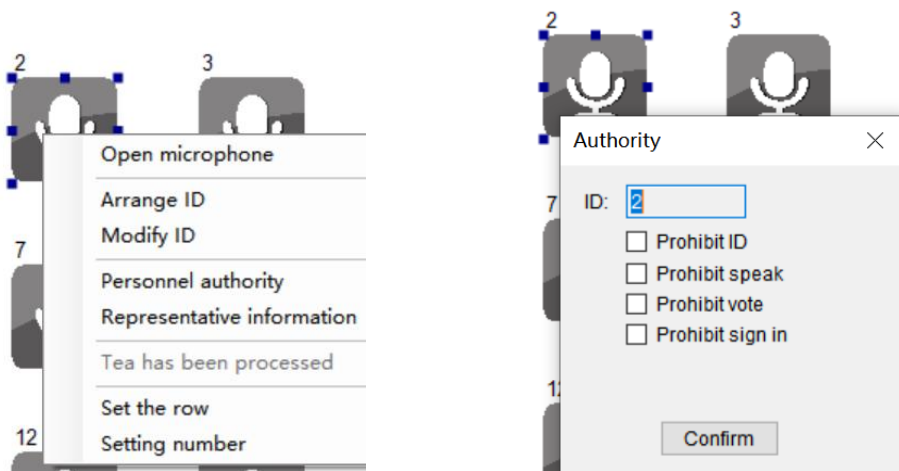



3.3.3.3 Usage

- The colors of the LEDs of the microphone buttons, the LED ring of MIC and display show the condition of the microphone that connected to the conference unit.

MIC button color	LED ring color	Display character	Condition
Red (on)	Red (on)	Mic on	Microphone enabled
White (off)	Green (on)	Applying to speak	Request to speak

	Please wait...	
--	----------------	--

- The unit has a concise and attractive appearance with a home screen displaying the following information: dual channel selectors that can be used by two users, both digital time and dial time, as well as the date. Tap the left setting button  to enter the unit feature setting screen or tap the right interpretation button  to enter the interpretation channel setting screen.



- Tap the setting button  to enter the settings menu. Then can set the unit language, screen brightness, sound effect, unit information, voting feature, and call service.

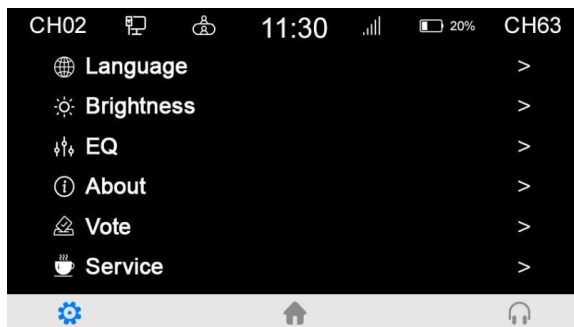

- Speech time and request to speak: After touch the microphone turn-on button, the screen displays the speech time of attendees in real time. After turn off the microphone, the screen displays the addresser information and the information of addressers in the request list. A chairman unit has the right to turn off the microphone of the addresser’s delegate unit and the right to accept or reject the request to speak from a delegate unit. Need to set corresponding user information of conference units in the VISSONIC conference management software.

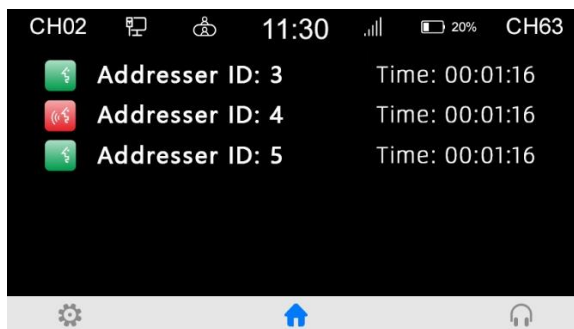

- Language and brightness: In the unit settings, the system allows to switch the unit language between Chinese and English. Language customization is available if a third language is

required. You can also adjust the screen brightness as needed.

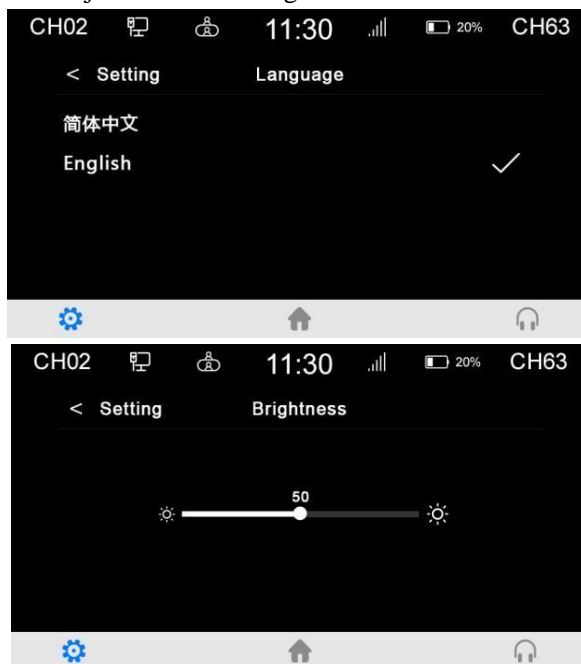

- The "Sound effect" setting provides 8-band EQ adjustment, EQ switch, EQ reset; and provides $\pm 12\text{dB}$ microphone sensitivity adjustment (although increasing the microphone sensitivity makes it easier to pick up small voices, it also makes it easier to pick up small noises and overload distortion, so please adjust carefully).

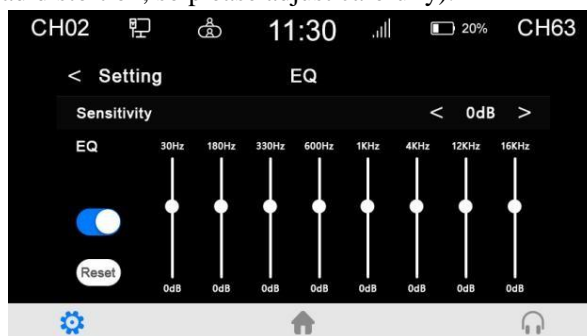

- In "About" settings, can view the unit authority and status information, including the unit type, current ID number, vote authority, speaking authority, and software version.

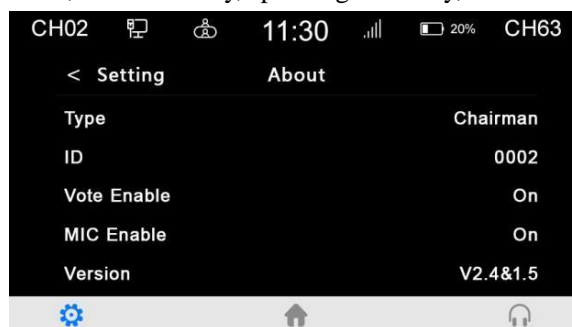

- Call service: The system provides a call service that can be customized for paper, pen, or tea service with one tap. The VISSONIC conference management software can receive calls

from conference units. The call service feature provides comfortable and fast services during conference.

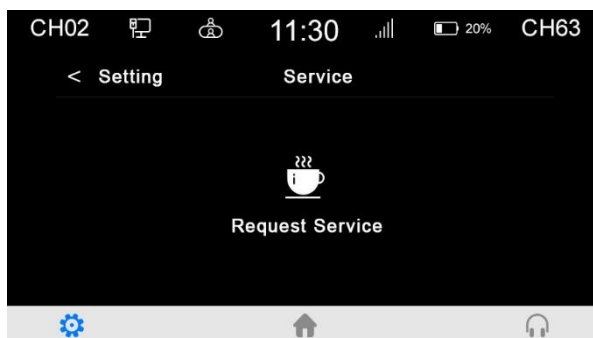

- The optional features are as follows. For more details, see *VISSONIC VIS-MAU-T Wired Touch screen Multimedia Conference Unit User Manual V1.0*.
 - ▶ IC card sign-in and information display function (software license model: VIS-LIDEN)
 - ▶ Voting function (software license model: VIS-LVOTE)
 - ▶ Dual 64-channel selector software module (software license model: VIS-LLGE)
 - ▶ Dual-user software (software license model: VIS-LDUAL)

3.4 VIS-ACC/ACD/DAC/DAD-T units

3.4.1 Features and interfaces

All units in this series are full-digital wired array conference units that use CAT5e cables for network communication. The product models and features are as follows:

- ✓ Digital Array Microphone with Channels Selector Chairman/Delegate Unit VIS-ACC-T/VIS-ACD-T
- ✓ Digital Array Microphone Chairman/Delegate Unit VIS-DAC-T/VIS-DAD-T

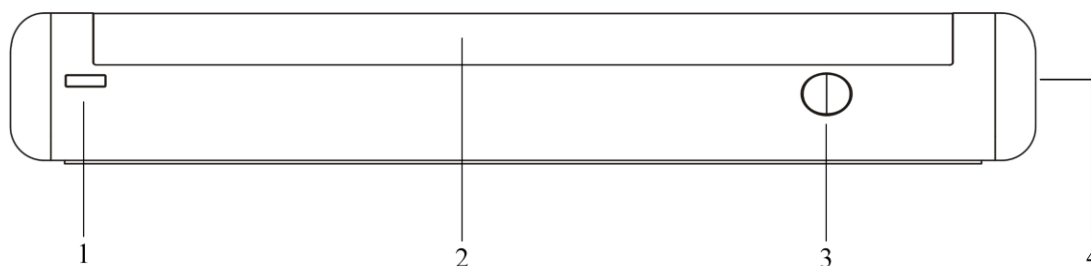
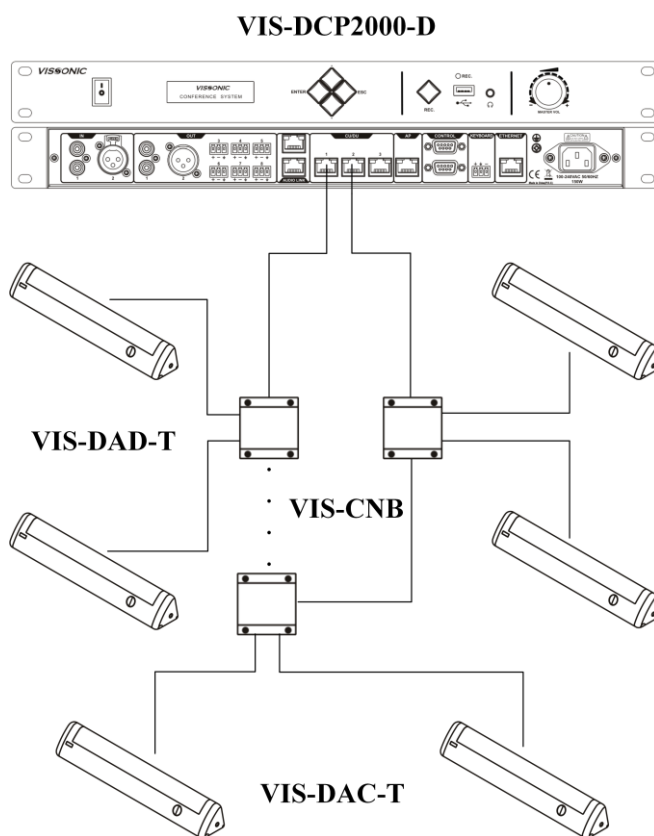

Figure 3.4.1 VIS-DAD/DAC-T array unit

No./Name	Description
1. Power Indicator	Red light represents working status.
2. High hardness speaker net	Built-in 17 high-pointing pickups.
3. Switch button	Hold down the switch button of chairman units for a few seconds to start the priority mode, it will turn off all the delegate units that are speaking.
4. Headphone jack	Standard 3.5mm headphone connector.

3.4.2 Connection

A VIS-CNB splitter box is required for every two array units. The following figure shows the connection of units in this series:



3.4.3 Settings and usage

- After the connection of all units, need to set the ID of each conference unit before first time using the conference system (If replace a unit with a new one or add a new unit, be sure to reset the new unit ID to prevent ID conflicts.), refer to Section 3.1.3.1.

Note: Unit IDs must be different. Units with the same ID may be turned on and off at the same time due to ID conflict. In addition, the corresponding microphones may buzz after being turned on or fail to output audio. If such issues occur, need to reset the units with different IDs.

- The colors of the LEDs of the microphone buttons, the LED ring of MIC and display show the condition of the microphone that connected to the conference unit.

MIC button color	LED ring color	Display character	Condition
Red (on)	Red (on)	Mic on	Microphone enabled
White (off)	Green (on)	Applying to speak Please wait...	Request to speak

3.5 VIS-DCC/DCD/CSU/DVU/SPK/FFC/FFD-F/FS/FS1/FS2/F1/F2 units

3.5.1 Features and interfaces

The units in this series are flush-mounting full-digital wired conference units that use CAT5e cables for network communication. This series can be used with different flush-mounting modules together to implement various features according to the actual needs. The product models and features are as follows:

- ✓ CAT5 Digital Flush-mounting Discussion Chairman/Delegate Unit VIS-DCC-F/VIS-DCD-F (all-round type) and VIS-DCC-FS/VIS-DCD-FS (economic type)
- ✓ CAT5 Digital Flush-mounting 64 Channels Selector Unit VIS-CSU-F
- ✓ CAT5 Digital Flush-mounting Voting Unit VIS-DVU-FS1 (with IC Card Reader) and VIS-DVU-FS2
- ✓ Flush-mounting Speaker Unit VIS-SPK-F
- ✓ Flush-mounting All-in-one Discussion Chairman/Delegate Unit with Voting and Channel Selector VIS-FFC-F1/VIS-FFD-F1 (simple type) and VIS-FFC-F2/VIS-FFD-F2 (big screen type)

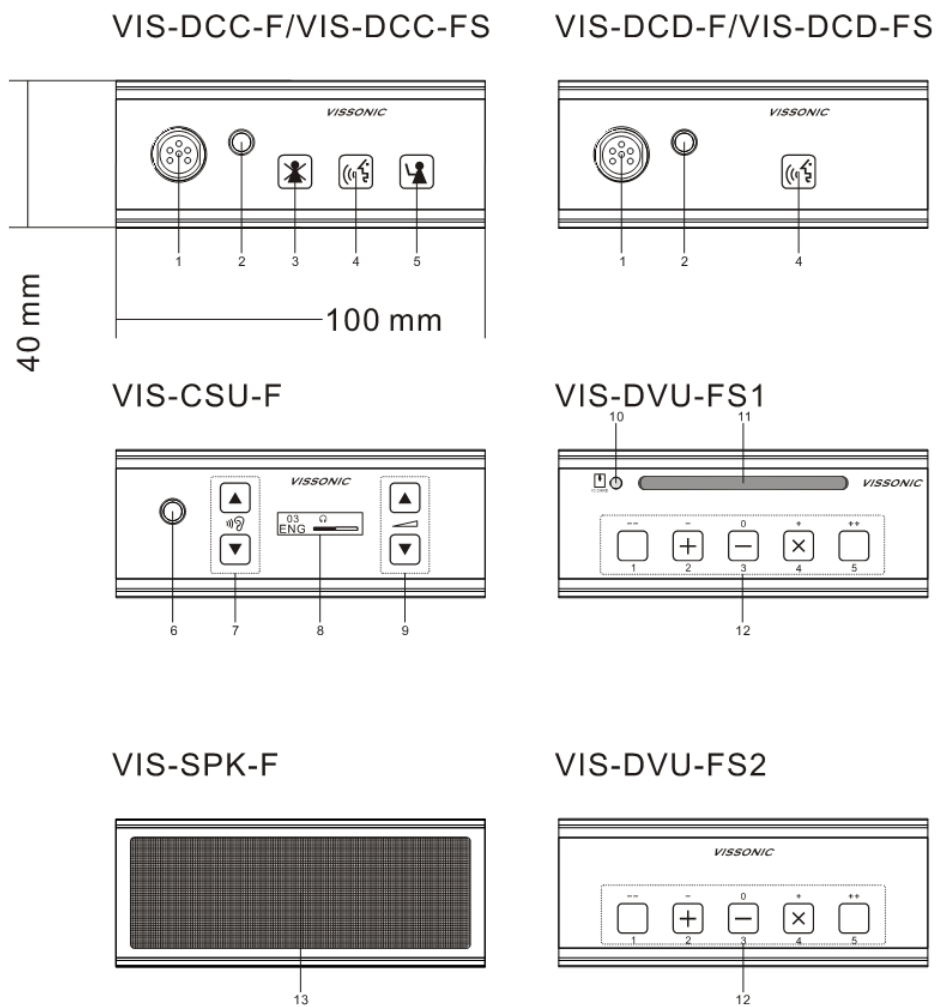

Figure 3.5.1.1 Front view of VIS-DCC/DCD/CSU/DVU/SPK-F/FS/FS1/FS2

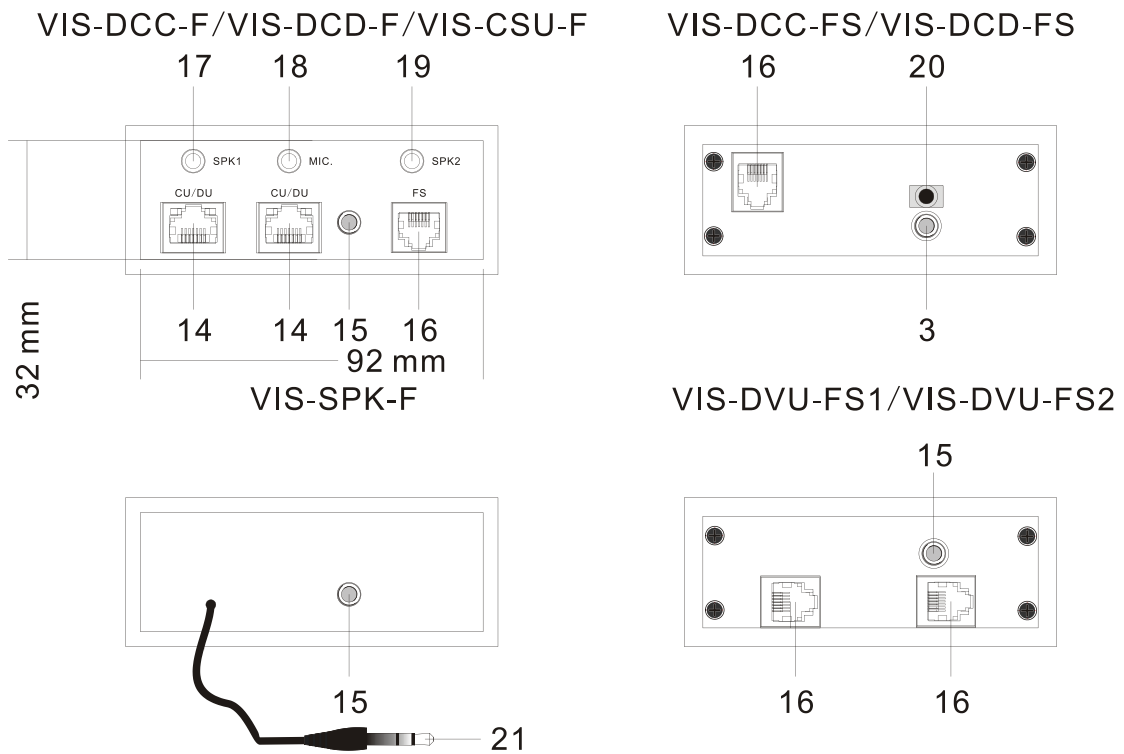

Figure 3.5.1.2 Rear view of VIS-DCC/DCD/CSU/DVU/SPK-F/FS/FS1/FS2



图 3.5.1.3 VIS-FFC/FFD-F1/F2 flush-mounting unit

No./Name	Description
1. Microphone socket	Connects a pluggable gooseneck microphone (VIS-M600, VIS-M410 or VIS-M330).

2. headphone jack	Standard 3.5mm headphone connector.
3. Clear button	Clear/deactivate all active delegate microphone or mute the system.
4. Microphone button	Turn on or off the microphone. The microphone button has a LED that shows the condition of the microphone.
5. Approval button	Approve the applying microphone to be enabled under the apply mode and work as mute while pressed clear button.
6. Interpretation channel headphone jack	Standard 3.5mm headphone connector.
7. Interpretation channel selecting button	It is used to switch the channel of interpretation for listening.
8. Display for interpretation channel	Displays the selected channel. VIS-FFC/FFD-F1 screen also displays time, microphone on/off, etc., and VIS-FFC/FFD-F2 screen displays time, microphone on/off, voting information, etc.
9. Volume control button for interpretation	Used to adjust the headphone volume.
10. IC card sign-in indicator	Used for IC card sign-in instructions.
11. IC card slot	Used to insert IC card to sign in.
12. Key voting and multi function buttons	Realize functions such as button sign-in, initiating voting, voting selection, stop sign-in, etc.
13. Speaker unit	2W high quality speaker
14. CU/DU port	CU/DU port for connecting between model VIS-DCC-F, VIS-DCC-F, VIS-CSU-F and controller, extension main unit, splitter box, etc.
15. Screw hole	Screw hole for installation
16. FS bus	FS bus for connecting model "-FS" unit
17. SPK1 port	SPK1 port is used to connect the VIS-SPK-F for working with current unit.
18. MIC port	connects to the model VIS-DCC-FS or VIS-DCD-FS and get the MIC input from model VIS-DCC-FS or VIS-DCD-FS
19. SPK2 port	SPK2 port to connect the VIS-SPK-F for working with the unit VIS-DCC-FS or VIS-DCD-FS which connecting to the current unit.
20. MIC port	Connect to the MIC port on the model VIS-DCC-F, VIS-DCD-F or VIS-CSU-F unit.
21. Speaker cable	3.5mm audio cable on VIS-SPK-F speaker unit connect to the SPK1 or SPK2 port on the VIS-DCC-F, VIS-DCD-F or VIS-CSU-F unit.

3.5.2 Installation

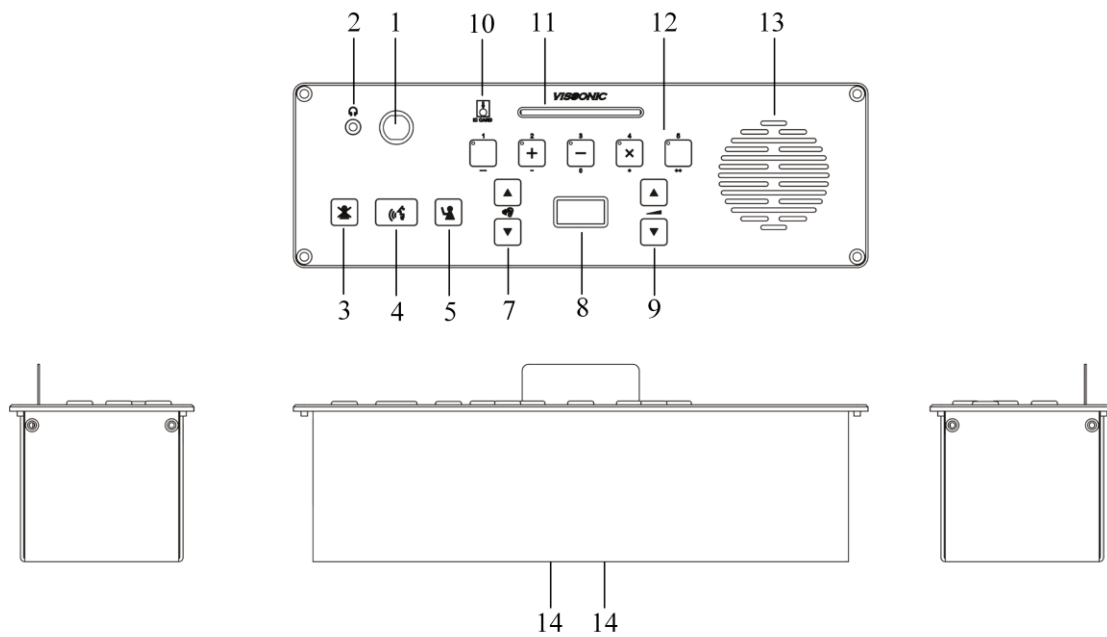
3.5.2.1 Hole sizes

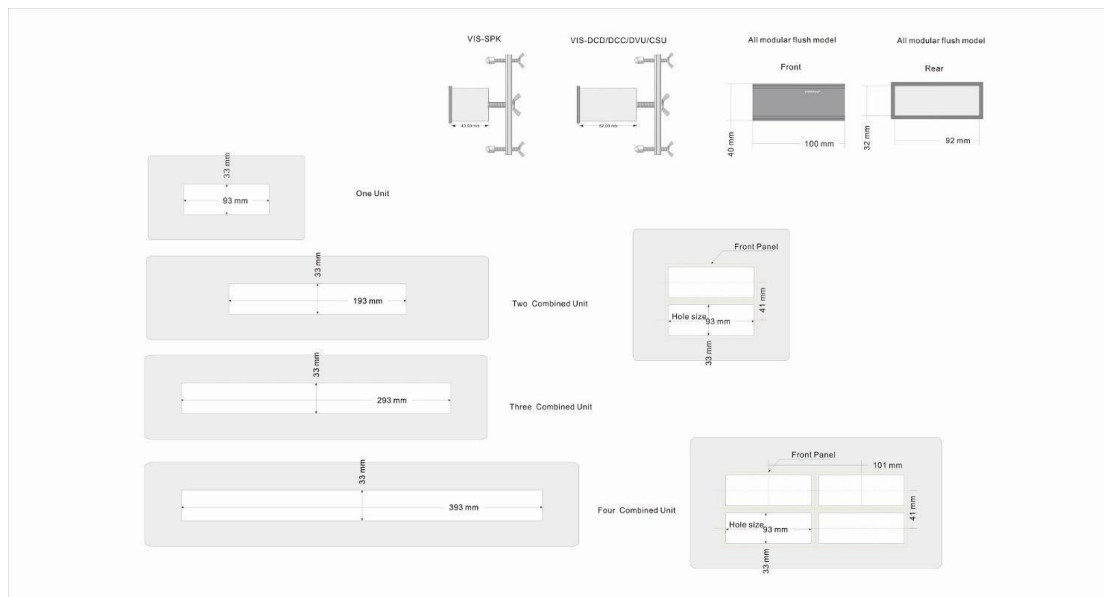
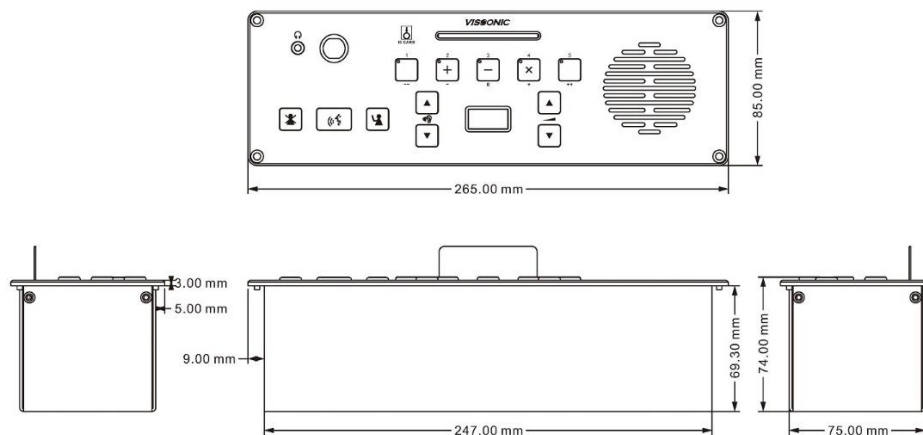

Figure 3.5.2.1.1 Sizes of mounting holes for VIS-DCC/DCD/CSU/DVU/SPK-F/FS/FS1/FS2



VIS-FFC-F1
Size(mm): 265(L)x85(W)x74(H)

Figure 3.5.2.1.2 Sizes of VIS-FFC/FFD-F1/F2

3.5.2.2 Installation steps

Installation steps:

1. Drill the square hole of the corresponding size on the desktop;
2. Put the flush mounting unit into the desktop with a square hole;
3. Install the fixed plate on the pressure riveting screw under the device;
4. Fix the fixed plate with the butterfly nut;
5. Install the M5 × 35mm wing/ butterfly screw to hold the fixed plate to the desktop, so as to fix the device.
6. Please see the Installation Diagram as below:

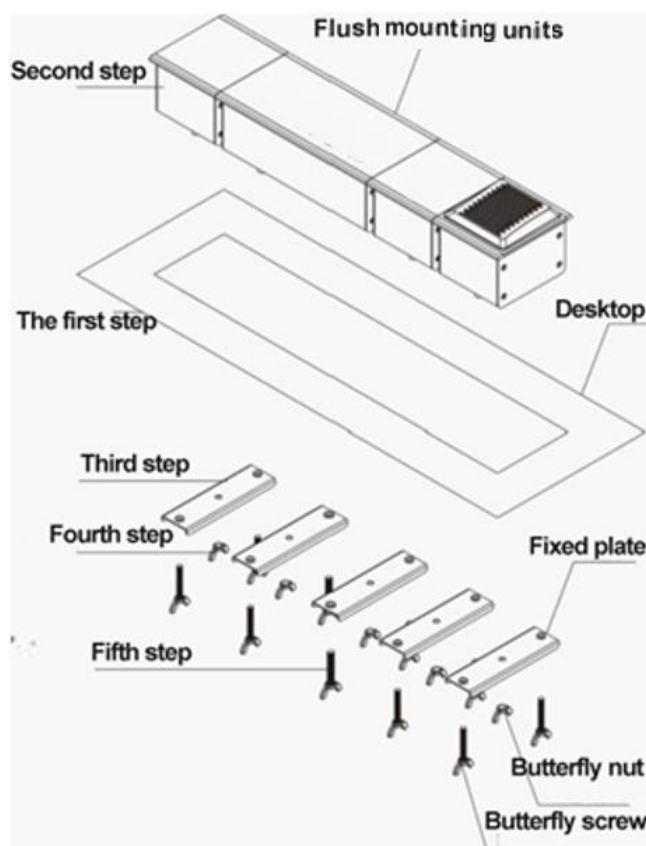

Figure 3.5.2.2 Installation steps of VIS-DCC/DCD/CSU/DVU/SPK-F/FS/FS1/FS2

3.5.3 Connection

The connection of VIS-DCC/DCD/CSU/DVU/SPK-F/FS/FS1/FS2 is shown in the figure below.

The connection of VIS-FFC/FFD-F1/F2 is the same as VIS-DCC/DCD-T, please refer to Section 3.1.2.

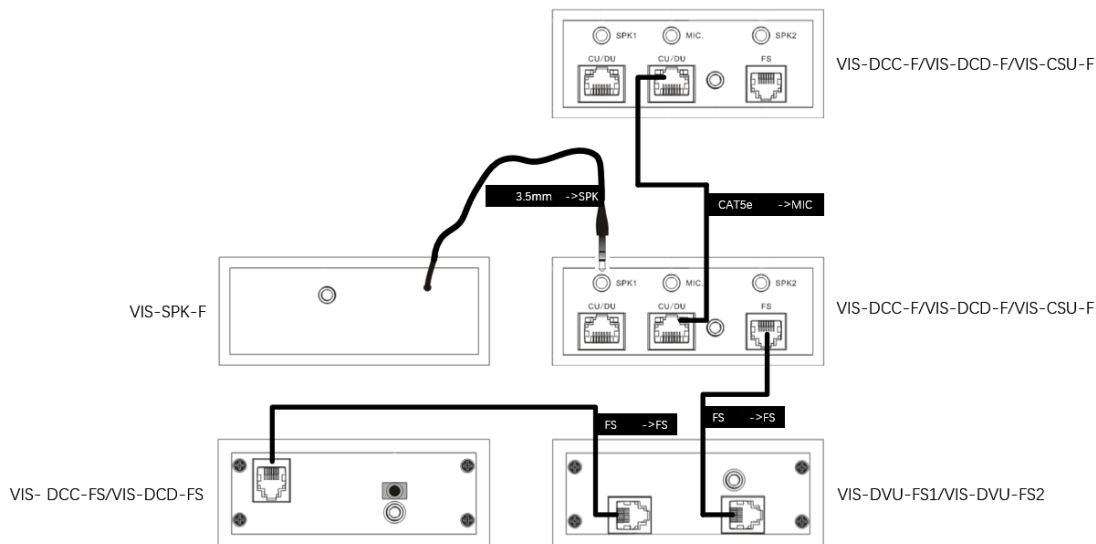

Figure 3.5.3 Connection of VIS-DCC/DCD/CSU/DVU/SPK-F/FS/FS1/FS2

3.5.4 Settings and usage

- After the connection of all units, need to set the ID of each flush-mounting unit before first time using the conference system (VIS-DVU-FS1/FS2 no need to set ID), VIS-CSU-F uses the "▲" button to select the ID number, refer to Section 3.1.3.1.

Note:

- ▶ Unit IDs must be different. Units with the same ID may be turned on and off at the same time due to ID conflict. In addition, the corresponding microphones may buzz after being turned on or fail to output audio. If such issues occur, need to reset the units with different IDs.
- ▶ If replace a unit with a new one or add a new unit, be sure to reset the new unit ID to prevent ID conflicts.

- The colors of the LEDs of the microphone buttons, the LED ring of MIC and display show the condition of the microphone that connected to the conference unit.

MIC button color	LED ring color	Display character	Condition
Red (on)	Red (on)	Mic on	Microphone enabled
White (off)	Green (on)	Applying to speak Please wait...	Request to speak

3.6 VIS-WDC/WDD/WVC/WVD/WVCIC/WVDIC-T units

3.6.1 Features and interfaces

The units in this series are desktop wireless digital units that support wireless communication through 5G WiFi. Dedicated battery pack and charger are used for the unit. The product models and features are as follows:

- ✓ Wireless Digital Discussion Chairman/Delegate Unit VIS-WDC-T/VIS-WDD-T
- ✓ Wireless Digital Discussion+Voting Chairman/Delegate Unit VIS-WVC-T/VIS-WVD-T
- ✓ Wireless Digital Discussion+Voting IC Card Chairman/Delegate Unit VIS-WVCIC-T/VIS-WVDIC-T
- ✓ Rechargeable battery pack VIS-WBTY1 and Charger for battery VIS-WCH1

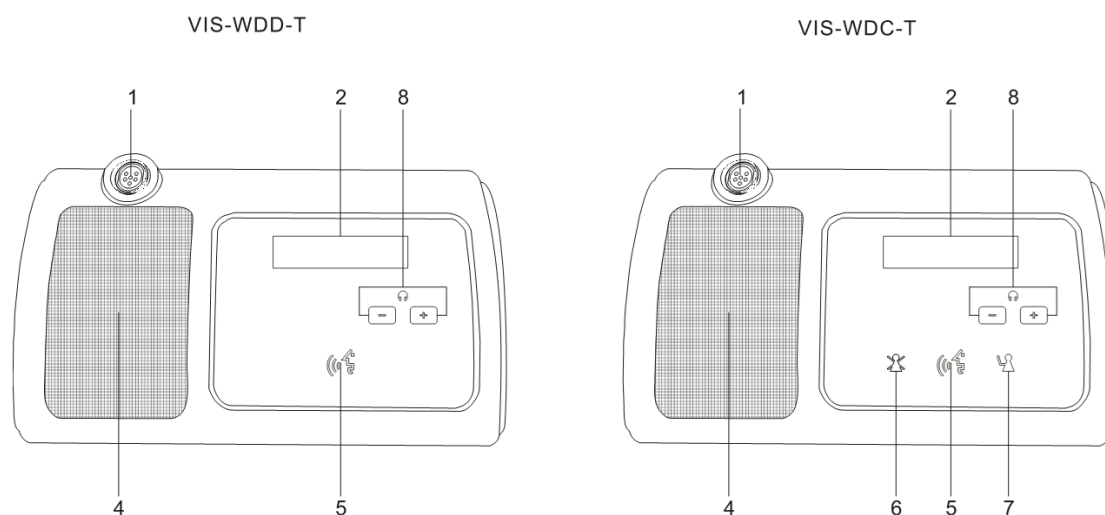

Figure 3.6.1.1 Top view of VIS-WDC/WDD-T

VIS-WVD-T/VIS-WVDIC-T

VIS-WVC-T/VIS-WVCIC-T

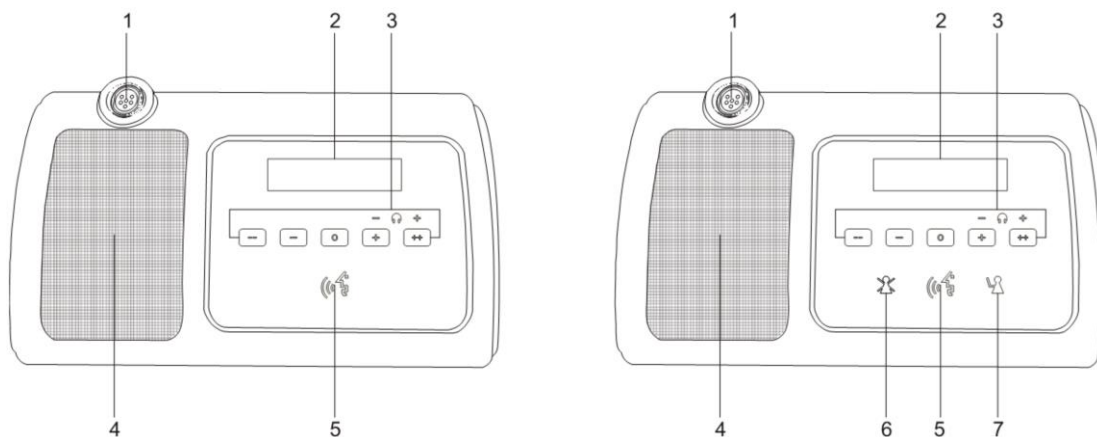

Figure 3.6.1.2 Top view of VIS-WVC/WVD/WVCIC/WVDIC-T

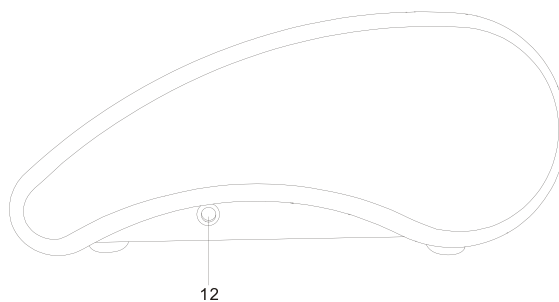
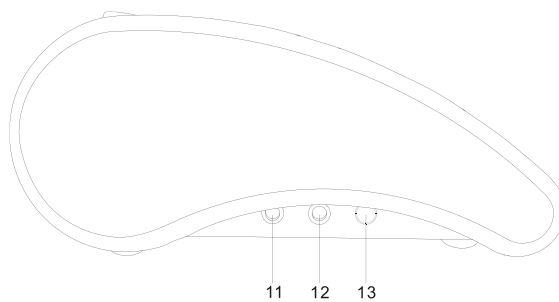

Figure 3.6.1.3 Left view and right view of wireless units



Figure 3.6.1.4 Rear view of wireless units

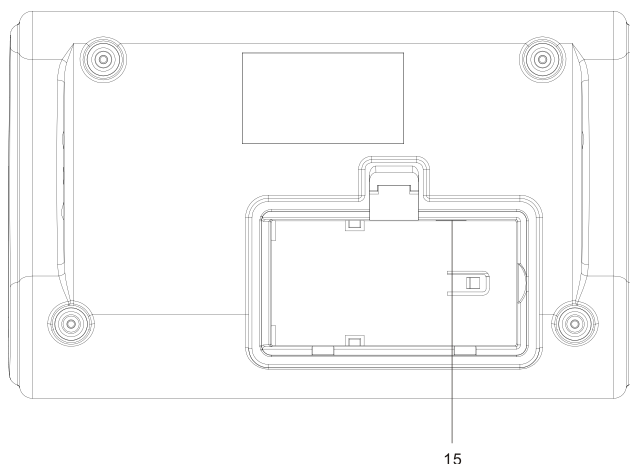

Figure 3.6.1.5 Bottom view of wireless units -without battery compartment cover

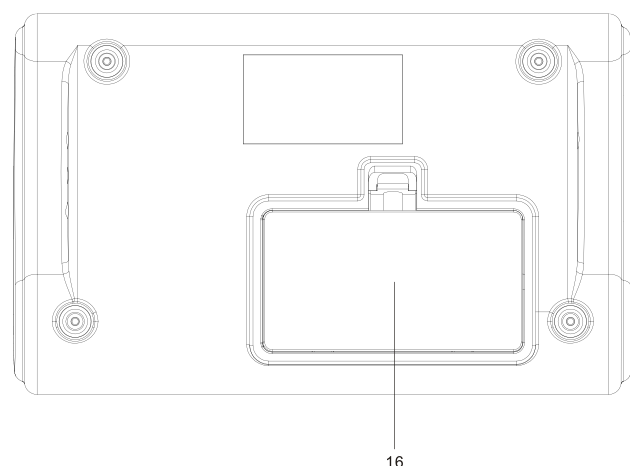
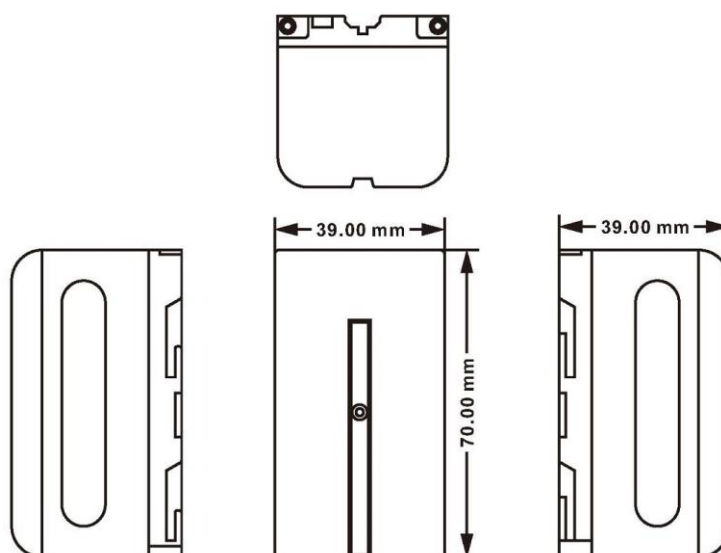

Figure 3.6.1.6 Bottom view of wireless units - with battery compartment cover

No./Name	Description
1. Microphone socket	Connects a pluggable gooseneck microphone (VIS-M600, VIS-M410 or VIS-M330).
2. OLED display	Display the MIC status, volume bar, interpretation channel, voting information, speaking time, clock and date.
3. 5 multi-function buttons	Apply the voting, volume adjustment for headphones, channel selector to select the channel that is sent to the headphone.
4. Loudspeaker	When the microphone is enabled, the signal of the loudspeaker is muted.
5. Microphone button	Turn on or off the microphone. The microphone button has a LED that shows the condition of the microphone.
6. Clear button	Clear/deactivate all active delegate microphone or mute the system.
7. Approval button	Approve the applying microphone to be enabled under the apply mode and work as mute while pressed clear button.
8. Volume button	Adjust the headphone volume.

11. Reserved custom interface	This interface can be customized for connecting a mobile phone or handheld microphone, or inputting another sound source from the conference unit to the conference system.
12. Headphone socket	Standard 3.5mm headphone connector.
13. Power switch	Power switch for the conference unit.
15. Battery socket	Used to install the VIS-WBTY1 battery pack to power the wireless unit.
16. Battery cover	For VIS-WBTY1 battery pack reinforcement.

The dedicated VIS-WBTY1 battery pack has a pogo connector for charging. The enclosure with a fastener prevents battery drop or poor contact during charging. The battery pack contains high-efficiency lithium-ion battery cells. A built-in microprocessor controls fast charging and trickle charging.



VIS-WBTY1

Size(mm): 39(L)x70(W)x39(H)

Figure 3.6.1.7 Dedicated VIS-WBTY1 battery pack

The VIS-WCH1 charger for battery can be used to charge eight batteries at the same time. Empty batteries can be fully charged in four hours. The bi-color LEDs on the charger indicate the charging status. Up to four chargers can be cascaded for battery charging.

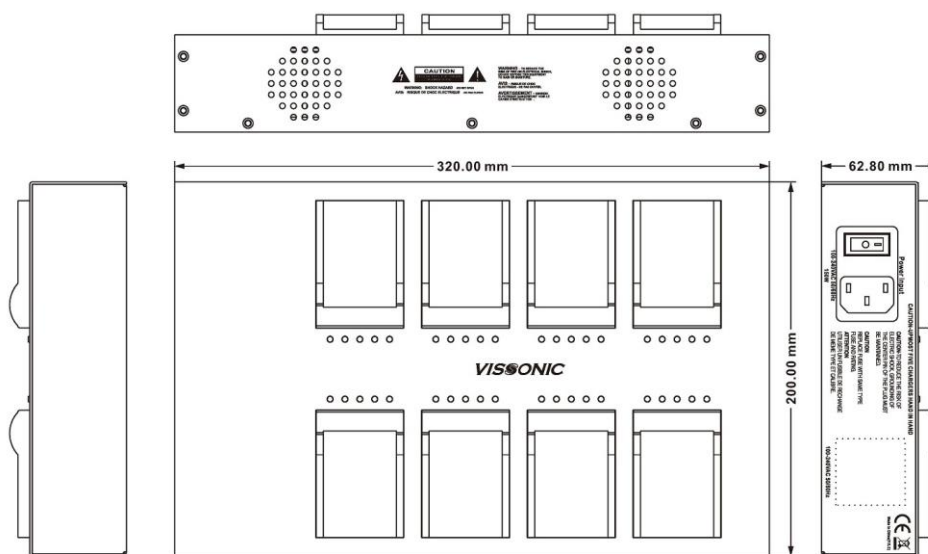

VIS-WCH1
Size(mm): 320(L)x200(W)x62.8(H)

Figure 3.6.1.8 VIS-WCH1 charger for battery

To remove the battery pack from a conference unit:

1. Turn the conference unit upside down.
2. Press the clip on the battery compartment cover (see Figure 3.6.1.6) with a thumb to loose the cover and then pull the cover outwards to remove it.
3. Slightly press on the middle of the battery pack (see Figure 3.6.1.5) and push the battery pack toward the left to loose the battery pack from the pogo pins.
4. Hold the battery pack and turn the conference unit upright to remove the battery pack.

3.6.2 Connection

A VIS-DCP2000-W wireless conference controller and VIS-AP4C APs are required to work with the wireless conference unit together, as shown in the following figure.

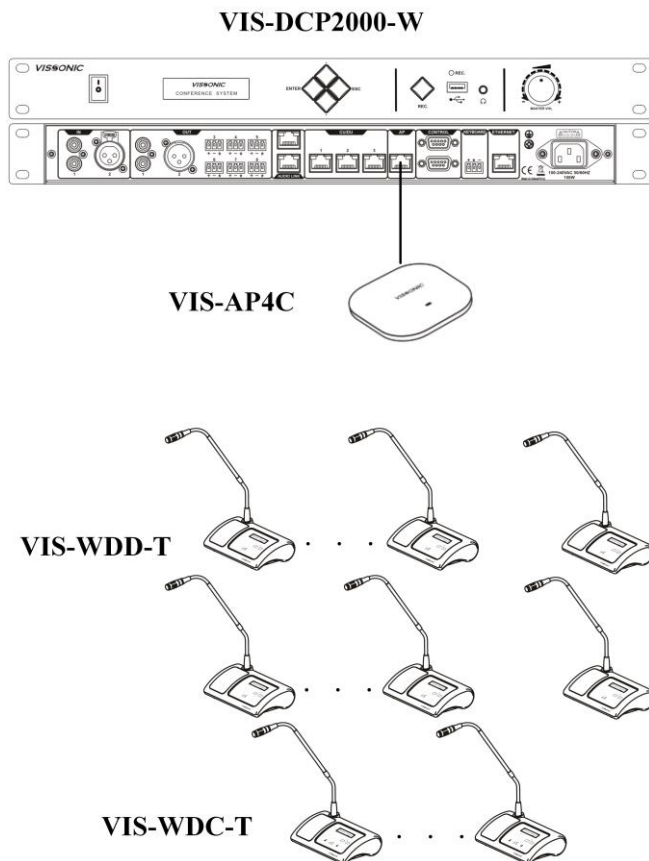

3.6.3 Settings and usage

- After the connection of all units, need to set the ID of each conference unit before first time using the conference system (If replace a unit with a new one or add a new unit, be sure to reset the new unit ID to prevent ID conflicts.), refer to Section 3.1.3.1.

Note: Unit IDs must be different. Units with the same ID may be turned on and off at the same time due to ID conflict. In addition, the corresponding microphones may buzz after being turned on or fail to output audio. If such issues occur, need to reset the units with different IDs.

- VIS-WVCIC/WVDIC-T has IC card sign-in function more than unit VIS-WVC/WVD-T (need to be set on PC software).
- If you need to change the AP frequency band or change the SSID and password of the wireless system, please refer to Section 6.4.
- The colors of the LEDs of the microphone buttons, the LED ring of MIC and display show the condition of the microphone that connected to the conference unit.

MIC button color	LED ring color	Display character	Condition
------------------	----------------	-------------------	-----------

Red (on)	Red (on)	Mic on	Microphone enabled
White (off)	Green (on)	Applying to speak Please wait...	Request to speak

- **Restore to factory settings.** When "Connecting..." is displayed on the screen after the conference unit is turned on, press the volume - and + buttons at the same time. The screen is displayed as follows:

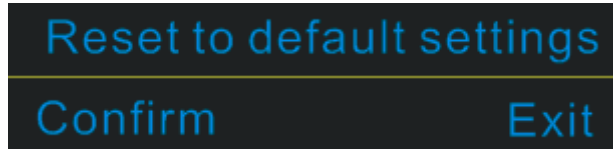

Select the "Confirm", then the conference unit is restored to factory settings.

3.7 VIS-MAW-T unit

3.7.1 Features and interfaces

VIS-MAW-T is a wireless multimedia conference unit with a 4.3-inch (800×480) touch screen. This unit supports network communication through CAT5e cable and 5G WiFi. The unit uses the dedicated VIS-WBTY2 battery pack and the VIS-WCH2 charger.

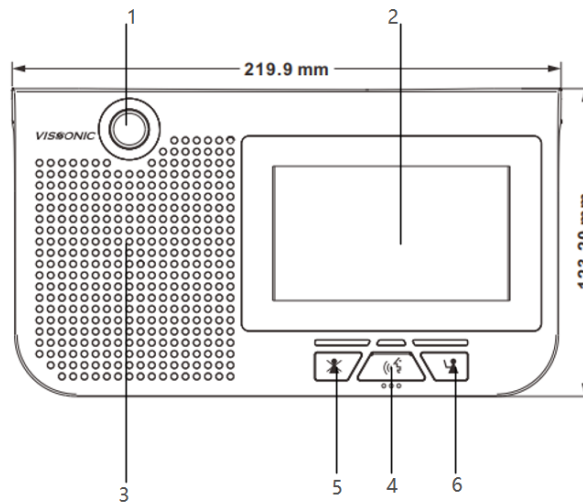

VIS-MAW-T

Figure 3.7.1.1 Top view of VIS-MAW-T

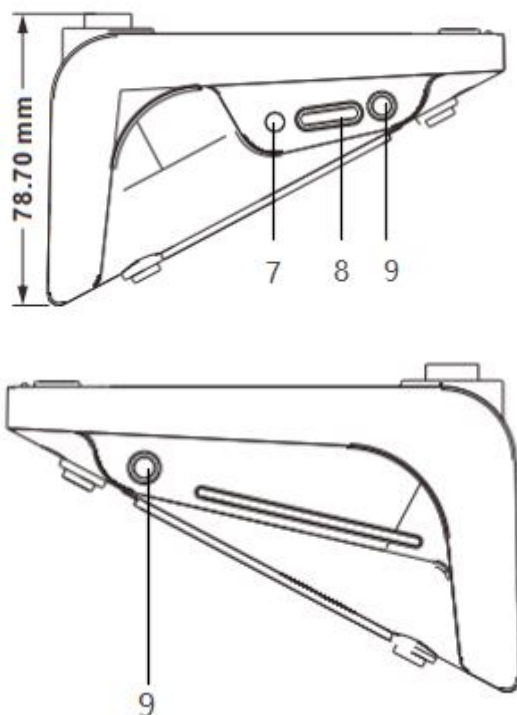

Figure 3.7.1.2 Left view and right view of VIS-MAW-T

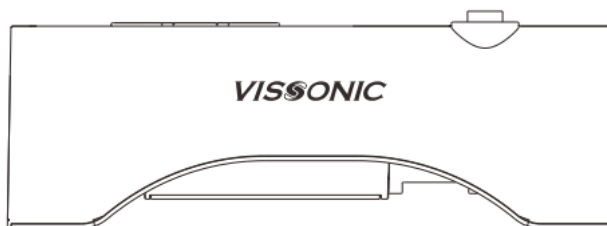
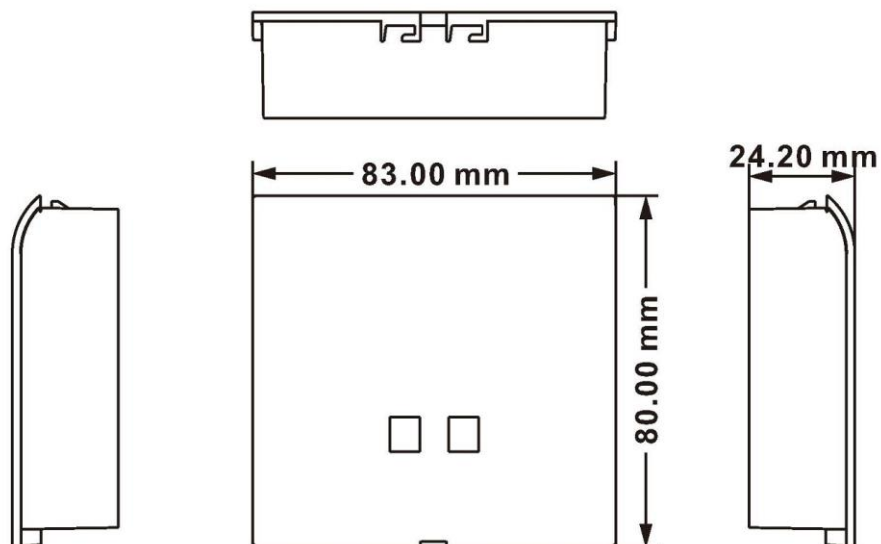

Figure 3.7.1.3 Rear view of VIS-MAW-T

No./Name	Description
1. Microphone socket	Connects a pluggable gooseneck microphone (VIS-M600, VIS-M410 or VIS-M330).
2. OLED display	Display the MIC status, volume bar, interpretation channel, voting information, speaking time, clock and date.
3. Loudspeaker	When the microphone is enabled, the signal of the loudspeaker is muted.
4. Microphone button	Turn on or off the microphone. The microphone button has a LED that shows the condition of the microphone.
5. Clear button	Clear/deactivate all active delegate microphone or mute the system.
6. Approval button	Approve the applying microphone to be enabled under the apply mode and work as mute while pressed clear button.
7. Power switch	Power switch for the conference unit.
8. Headphone Volume	Adjust the headphone volume.

Knob	
9. Headphone socket	Standard 3.5mm headphone connector.



VIS-WBTY2

Size(mm): 83(L)x80(W)x24.2(H)

Figure 3.7.1.4 VIS-WBTY2 battery pack

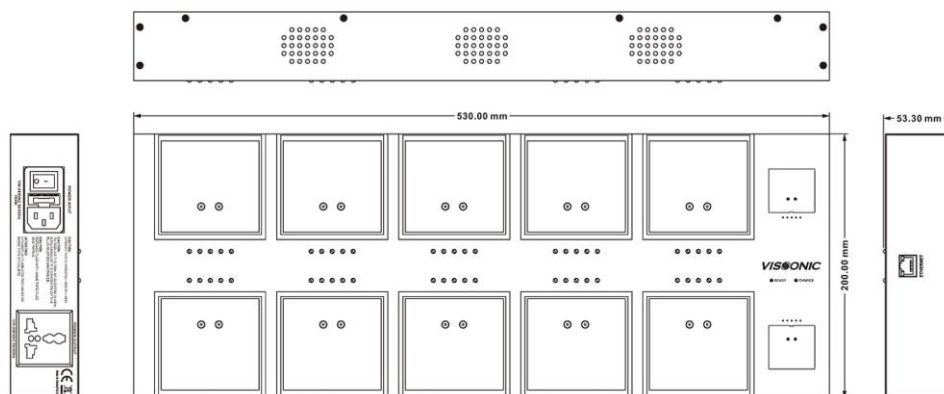

VIS-WCH2

Size(mm): 530(L)x200(W)x53.3(H)

Figure 3.7.1.5 VIS-WCH2 charger for battery

3.7.2 Connection

A VIS-DCP2000-W wireless conference controller and VIS-AP4C APs are required to work with the wireless conference unit together. VIS-MAW-T supports both wired and wireless connection, as shown in the following figure.

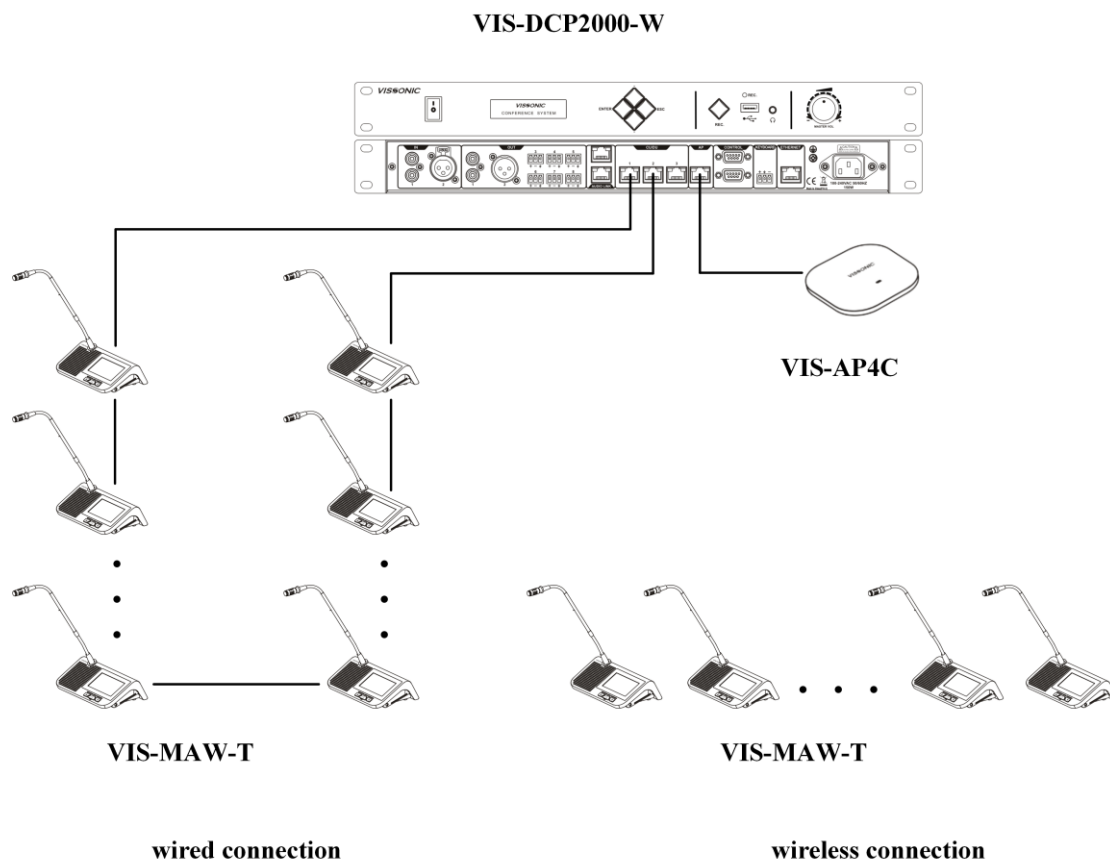

3.7.3 Settings and usage

3.7.3.1 Setting unit ID

After the connection of all units, need to set the ID of each conference unit before first time using the conference system (If replace a unit with a new one or add a new unit, be sure to reset the new unit ID to prevent ID conflicts.), refer to Section 3.1.3.1.

During the setting process, the unit will display the local ID (ID before setting) and the current ID (ID after setting) as shown in the figure below.

Note: Unit IDs must be different. Units with the same ID may be turned on and off at the same time due to ID conflict. In addition, the corresponding microphones may buzz after being turned on or fail to output audio. If such issues occur, need to reset the units with different IDs.

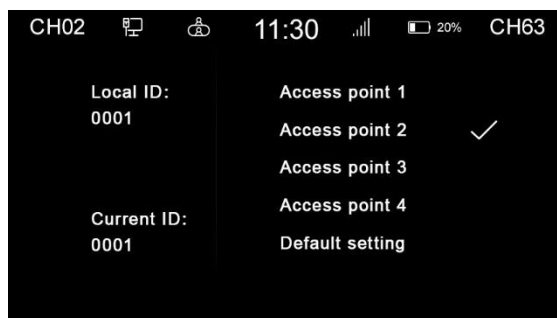

3.7.3.2 Setting unit types and rights

- Please refer to Section 3.1.3.2 for unit type setting. The unit type is displayed in the menu  → "About" → "Type".
- Use VISSONIC conference management software to set unit rights. In the management mode, right-click the unit icon and select personnel rights. Then set the unit rights, such as ID, speaking, voting, and sign-in.

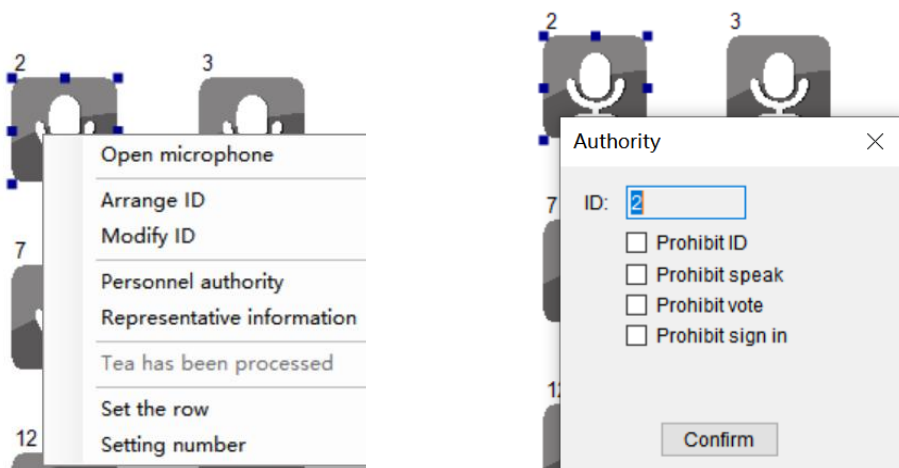



3.7.3.3 Usage

- The colors of the LEDs of the microphone buttons, the LED ring of MIC and display show the condition of the microphone that connected to the conference unit.

MIC button color	LED ring color	Display character	Condition
------------------	----------------	-------------------	-----------

Red (on)	Red (on)	Mic on	Microphone enabled
White (off)	Green (on)	Applying to speak Please wait...	Request to speak

- The unit has a concise and attractive appearance with a home screen displaying the following information: dual channel selectors that can be used by two users, both digital time and dial time, as well as the date. Tap the left setting button  to enter the unit feature setting screen or tap the right interpretation button  to enter the interpretation channel setting screen.



- Tap the setting button  to enter the settings menu. Then can set the unit language, screen brightness, sound effect, unit information, voting feature, and call service.

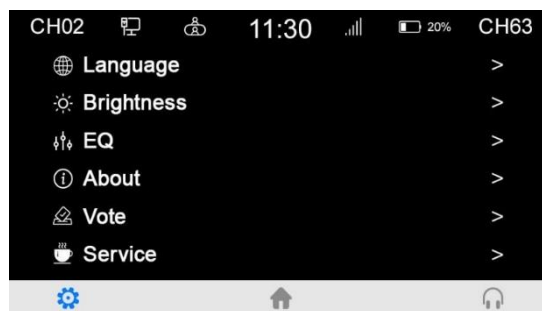

- Speech time and request to speak: After touch the microphone turn-on button, the screen displays the speech time of attendees in real time. After turn off the microphone, the screen displays the addresser information and the information of addressers in the request list. A chairman unit has the right to turn off the microphone of the addresser’s delegate unit and the right to accept or reject the request to speak from a delegate unit. Need to set corresponding user information of conference units in the VISSONIC conference management software.

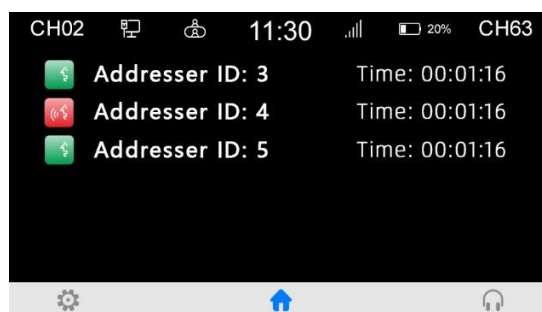

- Language and brightness: In the unit settings, the system allows to switch the unit language between Chinese and English. Language customization is available if a third language is required. You can also adjust the screen brightness as needed.

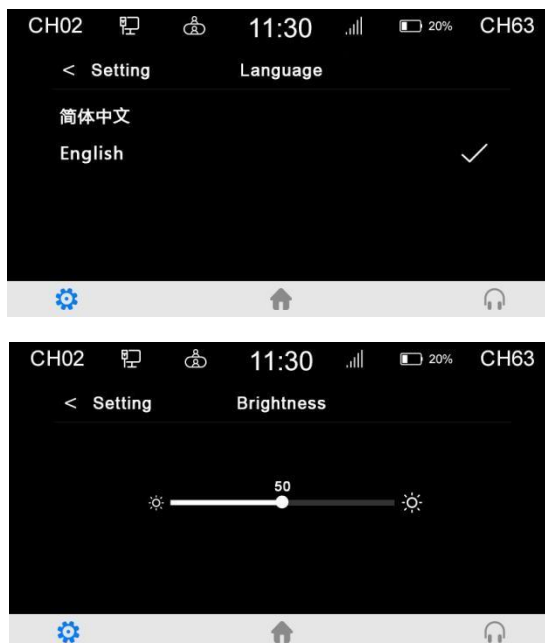

- The "Sound effect" setting provides 8-band EQ adjustment, EQ switch, EQ reset; and provides $\pm 12\text{dB}$ microphone sensitivity adjustment (although increasing the microphone sensitivity makes it easier to pick up small voices, it also makes it easier to pick up small noises and overload distortion, so please adjust carefully).

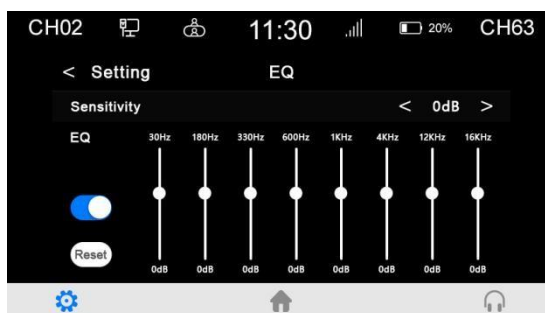

- In "About" settings, can view the unit authority and status information, including the unit type, current ID number, vote authority, speaking authority, and software version.

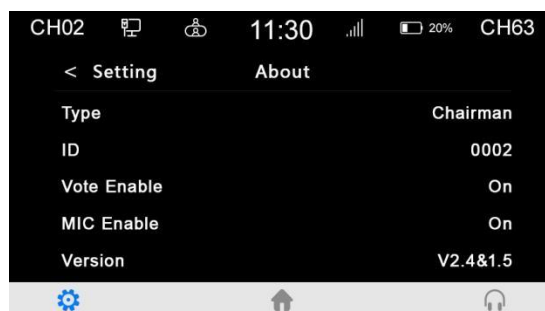

- Call service: The system provides a call service that can be customized for paper, pen, or tea service with one tap. The VISSONIC conference management software can receive calls from conference units. The call service feature provides comfortable and fast services during conference.

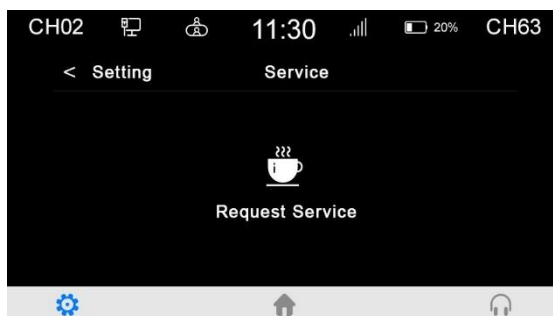

- You can turn off the conference controller directly when conference units are connected through WiFi. The conference units automatically shuts down in five minutes when they are not connected to an AP.
- When the wired mode is in use, if the unit connection cable is faulty or the unit needs to be moved, connect the AP to the conference controller. The connection cable can be removed when the unit is working, and the unit automatically connects to the AP without interrupting the speech.
- Restore to factory settings. In the wireless mode, open "About" settings and click the bottom-right corner of the version repeatedly.

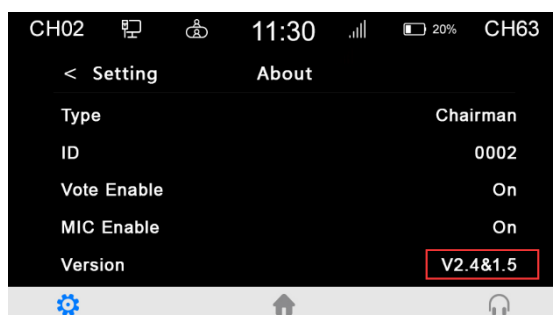

When the "Restore to factory settings" option is displayed on the screen, select this option. In addition, select the access point is also in this menu:

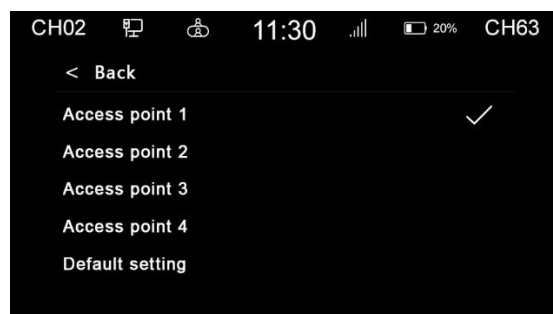

Then tap the microphone on/off button  and wait for reconnection.

- The conference unit supports three types of power supply: battery, unit base, and POE.
Note: If want to charge a unit over POE, need to connect the unit to a VIS-EXM directly, which is connected to the conference controller. In addition, be sure that the unit is not in communication state or connected to an AP.
- The battery capacity can be viewed on the unit screen, VISSONIC conference management software, and the Web page of the charger. For the Web-based management of the charger, see Section 3.7.4.

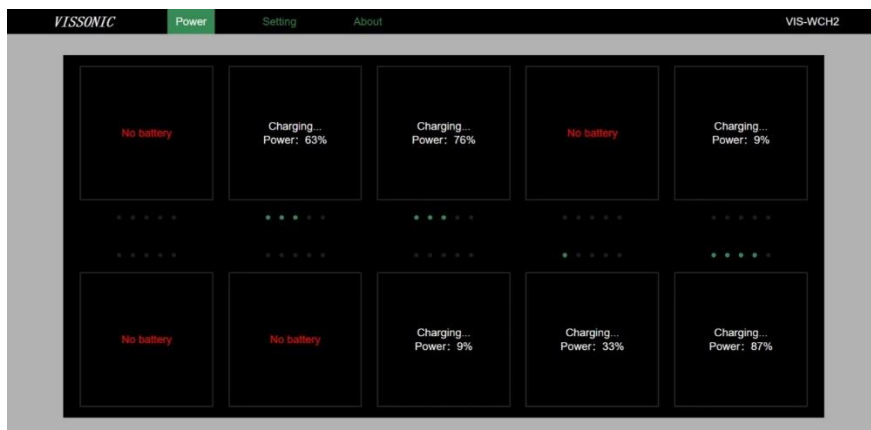

Figure 3.7.3.3 Battery capacity displayed on the Web page of the charger

- The optional features are as follows. For more details, see *VISSONIC VIS-MAW-T WiFi Wireless Multimedia Conference Unit User Manual V1.0*.
 - ▶ IC card sign-in and information display function (software license model: VIS-AIDEN)
 - ▶ Voting function (software license model: VIS-AVOTE)
 - ▶ Dual 64-channel selector software module (software license model: VIS-ALGE)
 - ▶ Dual-user software (software license model: VIS-ADUAL)

3.7.4 Web page of charger

3.7.4.1 Connection and login

1. A PC can be directly connected to a charger for battery or through a switch.
 - Connect the ETHERNET port to the network port of the PC. The connection is as follows.

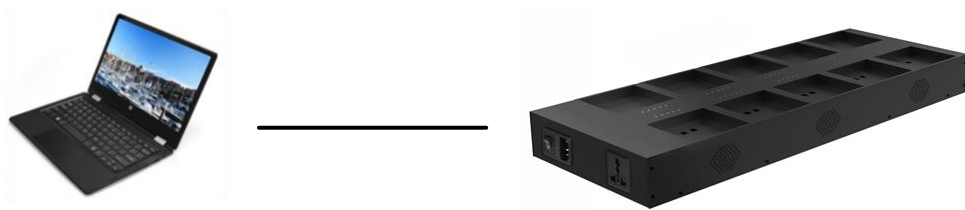

- The connection of a switch is shown in the following figure.



2. Open "Windows Settings" on the PC, select "Network & Internet", click "Change adapter options", right-click the Ethernet icon, and then click "Properties". In the "Ethernet Properties" dialog box, select "Internet Protocol Version 4(TCP/IPv4)", and then click the "Properties" button. Because the default IP address of the charger is 192.168.10.188, set an IP address in the same network segment as the charger for the PC, for example, 192.168.10.13, as shown in the following figure:

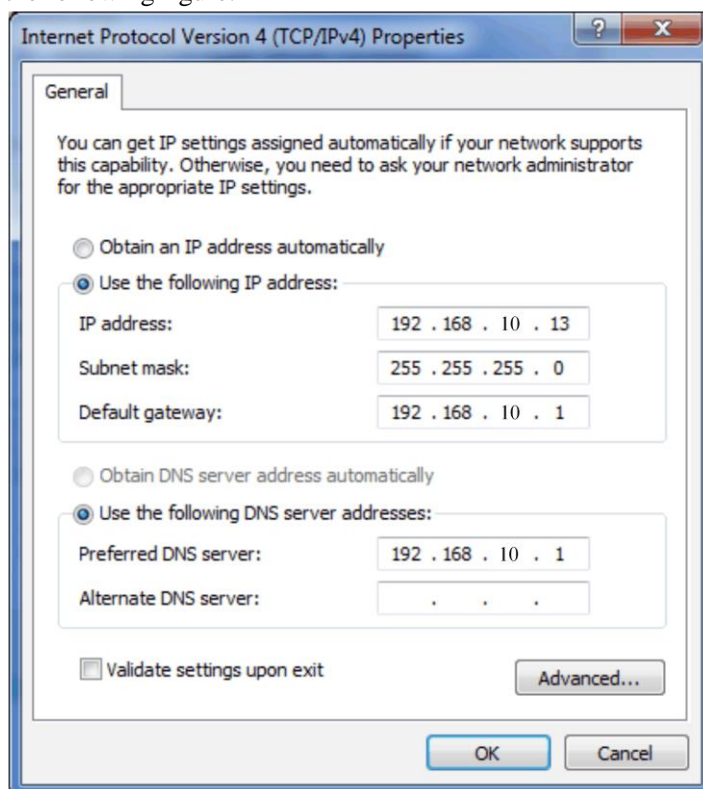

3. Enter the IP address 192.168.10.188 in the browser on the PC to log in to the Web page of the charger.

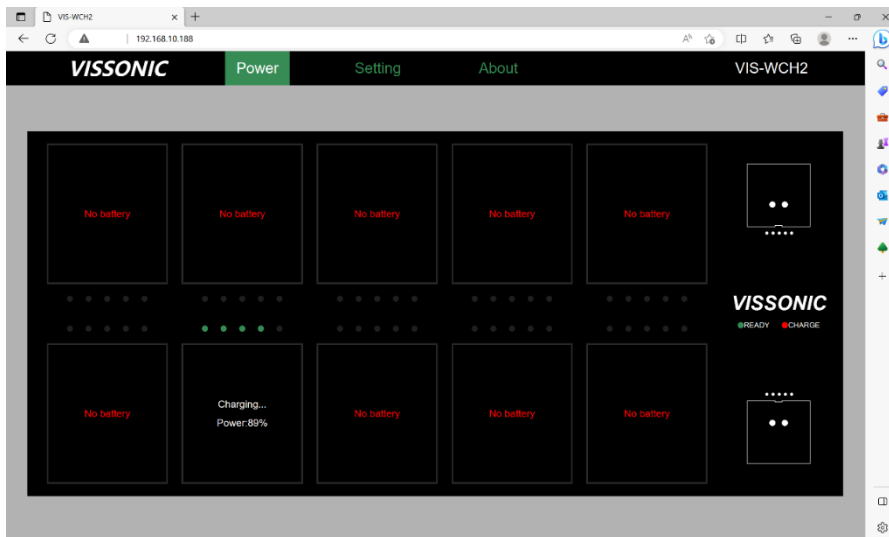

3.7.4.2 Web-based management

- Power page

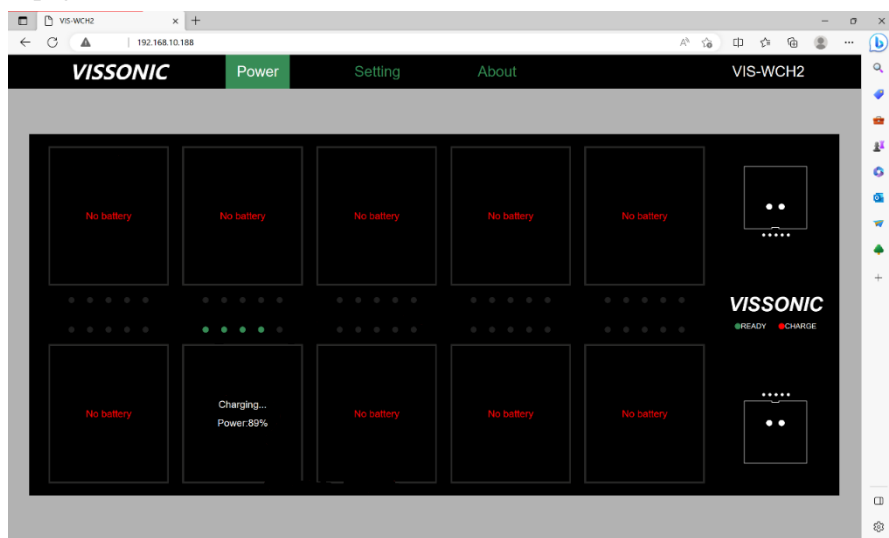

No battery is charged:

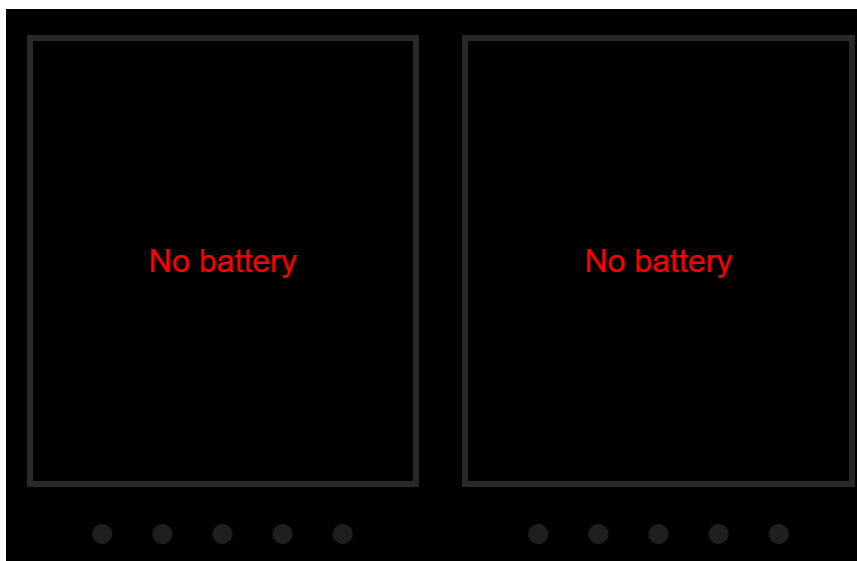

Batteries are being charged:

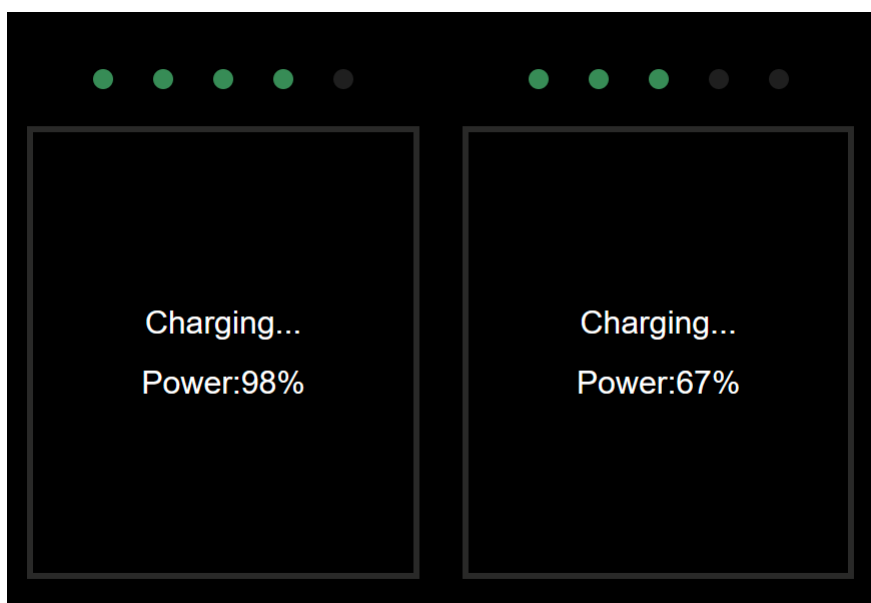

"Charging..." indicates that a battery is being charged. "Power:98%" indicates the current capacity of a battery.  Five indicators represent the capacity percentage of the corresponding battery. Each indicator represents 20% battery capacity. One indicator lit in green means that the capacity percentage reaches 20%. When all five indicators are lit in green, the battery is fully charged.

- Setting page

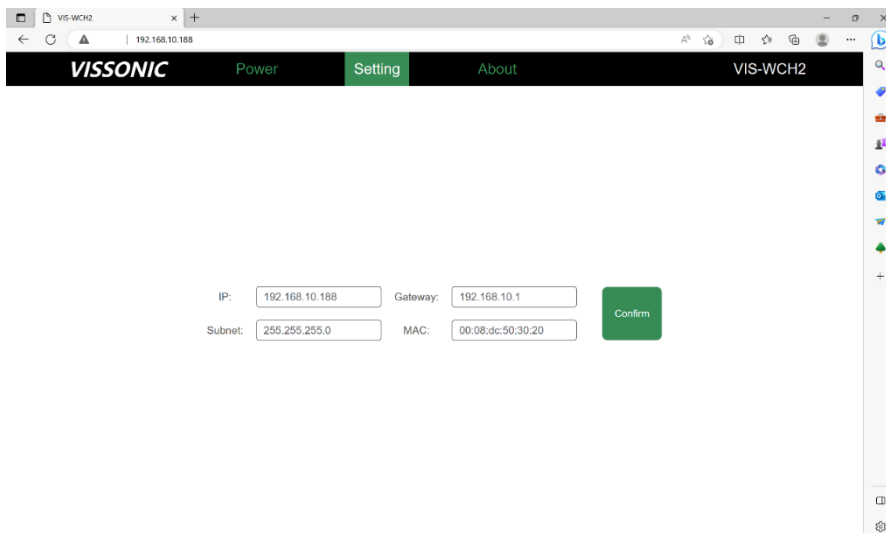

The page shows the IP address and gateway of the charger. You can change the IP address and gateway. Restart the charger to make the new settings take effect.

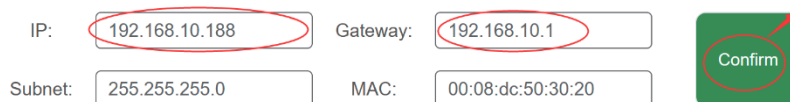

● About page

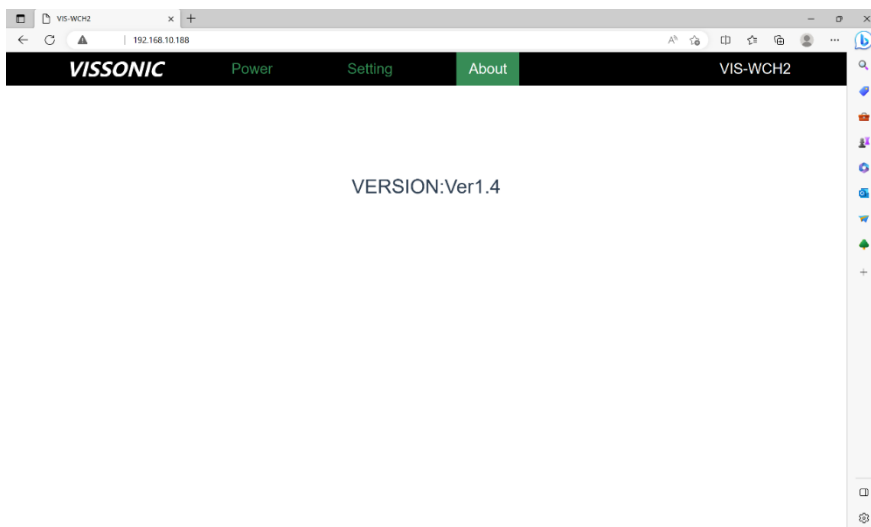

4. VIS-INT64 interpreter unit

The all-digital network interpreter unit VIS-INT64 is used by interpreter, which has 64 interpretation channels (include floor channel). Direct and relay interpretation are available. It has an LCD screen (resolution 320×64, white characters on a blue background), uses CAT5e wired network communication, and can be powered by POE or external 48V DC power supply.

VIS-INT64 can be connected to the conference controller, and also can be connected to the infrared transmitter.

4.1 Features and interfaces

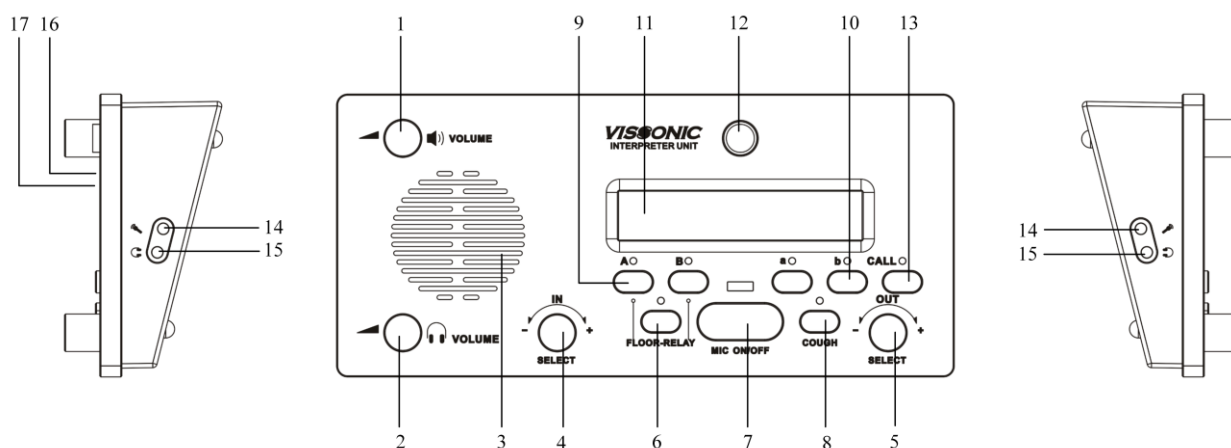

Figure 4.1 VIS-INT64

No./Name	Description
1. Speaker Volume Knob	Adjust speaker volume
2. Headphone Volume Knob	Adjust headphone volume
3. Built-in speaker	Realize the speaker function
4. IN SELECT knob	Select input channel
5. OUT SELECT knob	Select output channel
6. FLOOR-RELAY button	Used to switch between the floor channel and the relay interpretation channel.
7. Microphone button	Turn on or off the microphone. The microphone button has a LED that shows the condition of the microphone.
8. COUGH button	When the MIC is turned on, press and hold this button to mute the MIC for avoiding the cough voice output; release the button and the MIC resumes picking up voice.
9. Input channel shortcuts (A, B)	Press and hold the A or B button for 3 seconds, then the button is the shortcut of the current input channel.

10. Output channel shortcuts (a, b)	Press and hold the a or b button for 3 seconds, then the button is the shortcut of the current output channel.
11. LCD	320×64. The left half of the screen displays the input channel number and language, and the right half displays the output channel number and language.
12. Microphone socket	Connects a pluggable gooseneck microphone (VIS-M600, VIS-M410 or VIS-M330).
13. CALL button	Multi-function button. Used to switch the unit type to interpreter unit or operator unit, and to enter the service menu, see Section 4.3.2 and 4.3.3 for details.
14. Microphone jack	For connecting headphone with mic
15. Headphone jack	For connecting headphone with mic
16. CU/DU socket	2×RJ45, support POE, used to connect controller or interpreter unit.
17. power socket	48V DC power input

4.2 Connection

4.2.1 Connected to controller

Use a CAT5e cable to connect the CU/DU port of the VIS-INT64 to the CU/DU port of the conference controller, as shown in the figure below. Note that the delegate unit must be equipped with channel selector to listen.

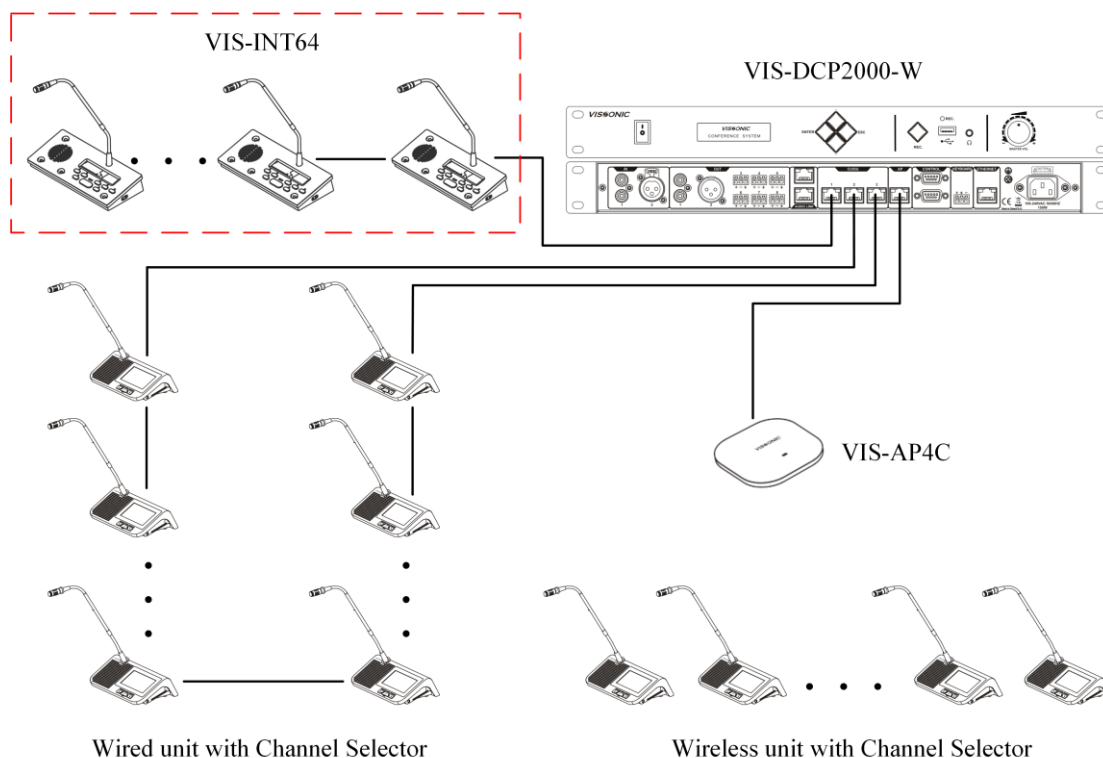

Figure 4.2.1 VIS-INT64 connected to controller

4.2.2 Connected to infrared transmitter

It is also possible to connect the CU/DU port of VIS-INT64 to the AUDIOLINK port of the infrared transmitter VIS-VLI1700A, as shown in the figure below (note that the first interpreter unit directly connected to the infrared transmitter needs to use a power adapter). Attendees use infrared receiver VIS-VLI703A to listen.

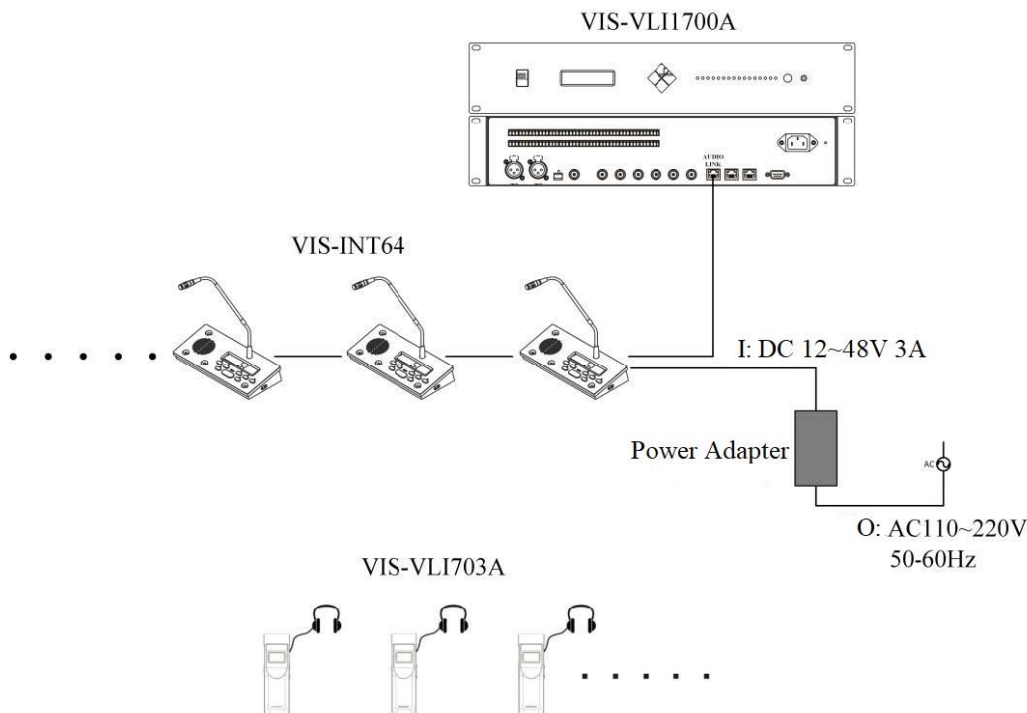

Figure 4.2.2 VIS-INT64 directly connected to infrared transmitter

4.3 Settings and usage

4.3.1 Setting unit ID (only for connected to controller)

Before first time using the conference system, need to set the ID of each VIS-INT64 in the same way as the conference unit, and also use the MIC button to select the ID, refer to Section 3.1.3.1.

During the setting process, the interpreter unit will display the local ID (ID before setting) and the current ID (ID after setting).

Including all interpreter units and conference units:

- ▶ Unit IDs must be different. Units with the same ID may be turned on and off at the same time due to ID conflict. In addition, the corresponding microphones may buzz after being turned on or fail to output audio. If such issues occur, need to reset the units with different IDs.
- ▶ If replace a unit with a new one or add a new unit, be sure to reset the new unit ID to prevent ID conflicts.

4.3.2 Setting interpretation channel

If VIS-INT64 is connected to the conference controller, set the number of interpretation channels and bind the channel language on the controller; if it is connected to the infrared transmitter, set and bind on VIS-INT64.

- **It is connected to the controller**

After setting the unit ID, need to set the relevant parameters in the "Interpretation" menu of the controller. For details, please refer to Section 2.1.4.7.

- **It is connected to the infrared transmitter**

1. When the VIS-INT64 is turned on, press the CALL button to enter the password input screen. The password is 2468. Use the CALL button to switch digits, use the OUT SELECT knob to select the value of the digit, and select "Enter" after input the password to enter the setting screen.
2. Use the OUT SELECT knob to select "CH MAP", press the CALL button to enter the screen for setting the maximum number of interpretation channels, use the OUT SELECT knob to select the maximum number (for example, if select 6, the screen will display "CH Total: 06"), press the CALL button to enter the binding channel language screen.
3. Because channel 00 is used for the floor, only 63 channels (01-63) can be set at most. Use the OUT SELECT knob to select the language, press the CALL button to enter the next channel. After setting the last channel, press the CALL button to return to the setting screen.
4. Use the OUT SELECT knob to select "EXIT" and press the CALL button to exit the setting screen, and then you can use it normally. For more information about infrared system, please refer to "VISSONIC IR Language Distribution System User Manual 1.0".

4.3.3 Usage

4.3.3.1 Setting operator

VIS-INT64 can be configured as operator unit. The method of setting the operator unit is as follows:

- ① When the VIS-INT64 is turn off, press and hold the "CALL" button;
- ② Then turn on the VIS-INT64, release the button until displays the operator screen, and the setting is completed.

- ③ Use the same method to set the operator unit back to the interpreter unit.

The operator unit is usually installed in the equipment room. It can monitor the interpretation channel and the floor channel, and call with other interpreter units. The "IN SELECT" knob is used to select the channel to be monitored.

The display of the operator unit LCD is as follows:

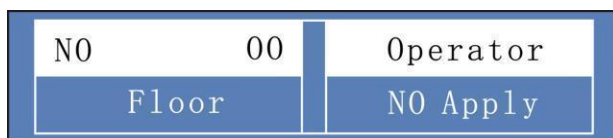

When there is a call request, the display as follows:

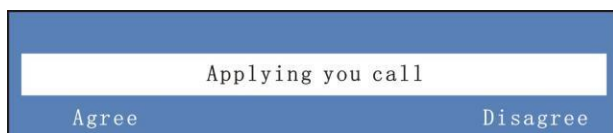

Select "Agree", the call starts, and the displays as follows:



After the call, select "Exit" to end.

4.3.3.2 Screen contents

The display content of the interpreter unit LCD is as follows:

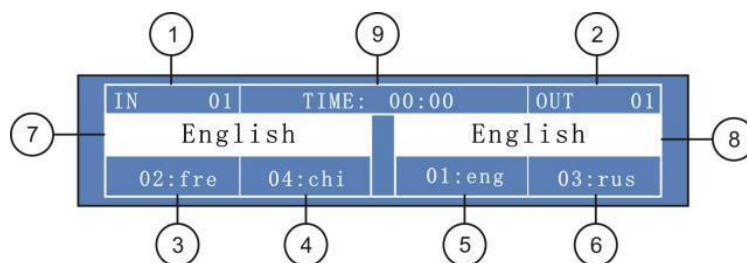

- ① Input channel number.
- ② Output channel number.
- ③ Input channel and language corresponding to the input channel shortcut A.

- ④ Input channel and language corresponding to the input channel shortcut B.
- ⑤ Output channel and language corresponding to the output channel shortcut a.
- ⑥ Output channel and language corresponding to the output channel shortcut b.
- ⑦ Current input channel language.
- ⑧ Current output channel language.
- ⑨ Interpretation timing, the maximum timing is 99 minutes and 59 seconds.

In the conference mode, press the "CALL" button to enter the service screen as shown in the figure below, where can make internal calls, apply for tea, and view short message services.

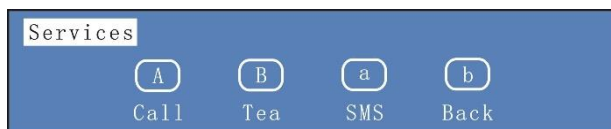

Press the "A" button to enter the intercom; press the "B" button to enter the tea application; press the "a" button to view the SMS; press the "b" button to exit the service screen.

5. Extension devices

5.1 VIS-EXM extension main unit

The extension main unit VIS-EXM is used for connecting more conference units in a conference system and increasing the communication distance of the conference system.

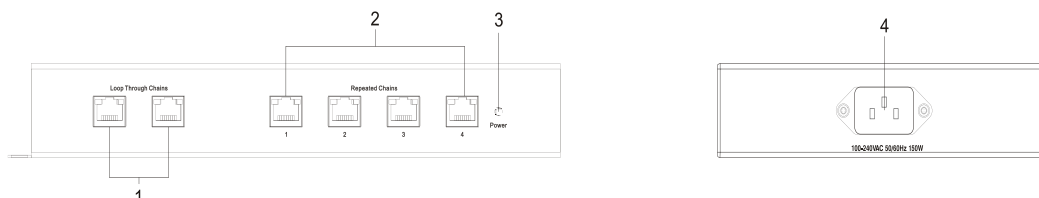

Figure 5.1 Front and side panels of VIS-EXM

No./Name	Description
1. Loop Through Chains	One is used to connect the controller/the previous extension main unit, and one is used to connect the next extension main unit.
2. Repeated Chains	Provide 4 channels for delegate/chairman units or 2 POE loudspeakers.
3. Power indicator	Indicate status of the power inlet connection.
4. Power inlet	Connect the extension main unit with power cable, supports 100V to 240V 50/60Hz power input.

5.2 VIS-CNB splitter box

The splitter box is used for split connections and array units.

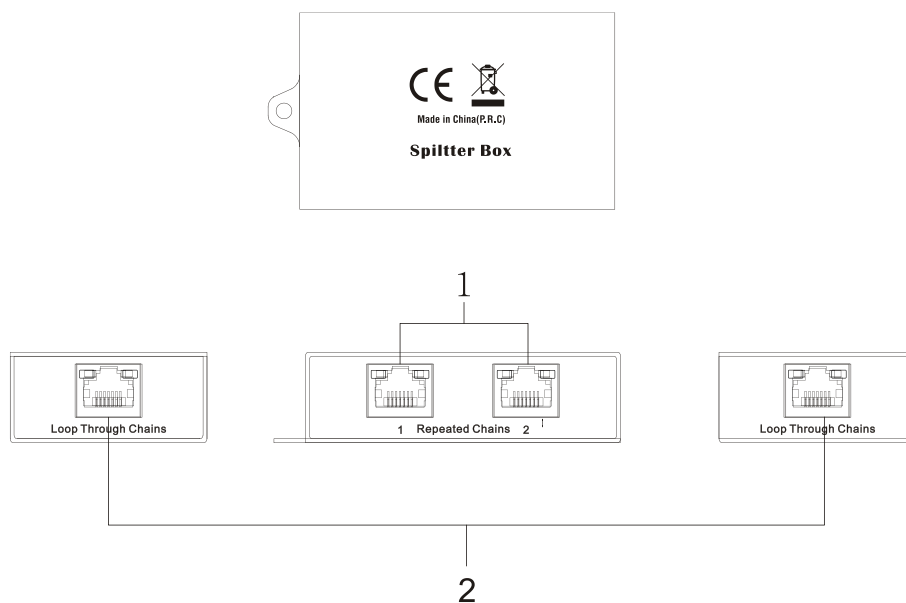

Figure 4.2 Front and rear panels of VIS-CNB and top cover

No./Name	Description
1. Repeated Chains	Spilt two chains for delegate/chairman units
2. Loop Through Chains	Connect to the controller, extension main unit or loop to next splitter box.

5.3 VIS-HL network cable

The series network cable includes VIS-HL002 2-meter network cable, VIS-HL005 5-meter network cable, VIS-HL010 10-meter network cable, VIS-HL020 20-meter network cable, VIS-HL050 50-meter network cable, VIS-HL100 100-meter network cable in various specifications.

6. AP

6.1 Features and interfaces

The dedicated APs VIS-AP4C is used to communication between a wireless conference controller and wireless conference units.

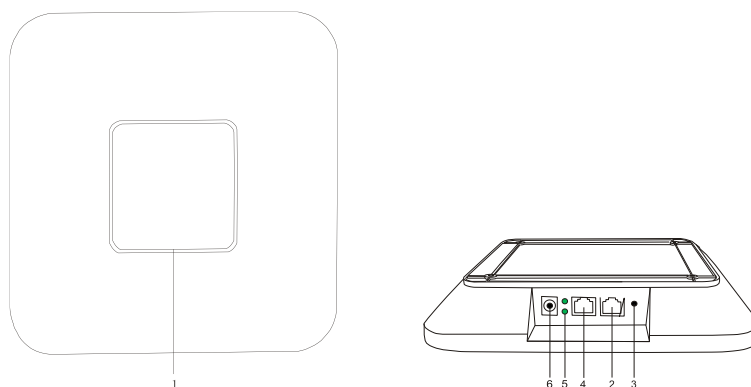

Figure 5.1 Top panel and side interfaces of VIS-AP4C

No./Name	Description
1. Working signal indicator	When the AP is connected with power, it will be static blue light. When AP is communicating, the indicator is flashing.
2. LAN port	Connect to PC or POE switch.
3. Reset button	Restore the device to the original factory settings.
4. WAN/POE port	Connects to the AP port of conference controller, POE switch, or VIS-CNB splitter box.
5. LED indicator	Indicates the network connection status.
6. Power socket	It can be powered by an external DC 12V power adapter.

Note: It is not recommended to connect other devices to the POE switch. It should connect the VIS-DCP2000-W and up to 8 VIS-AP4C.

6.2 Installation

6.2.1 Installation diagram

The AP need to install in the same room as the conference units. The AP can be wall-mounted or ceiling installation, as shown below.

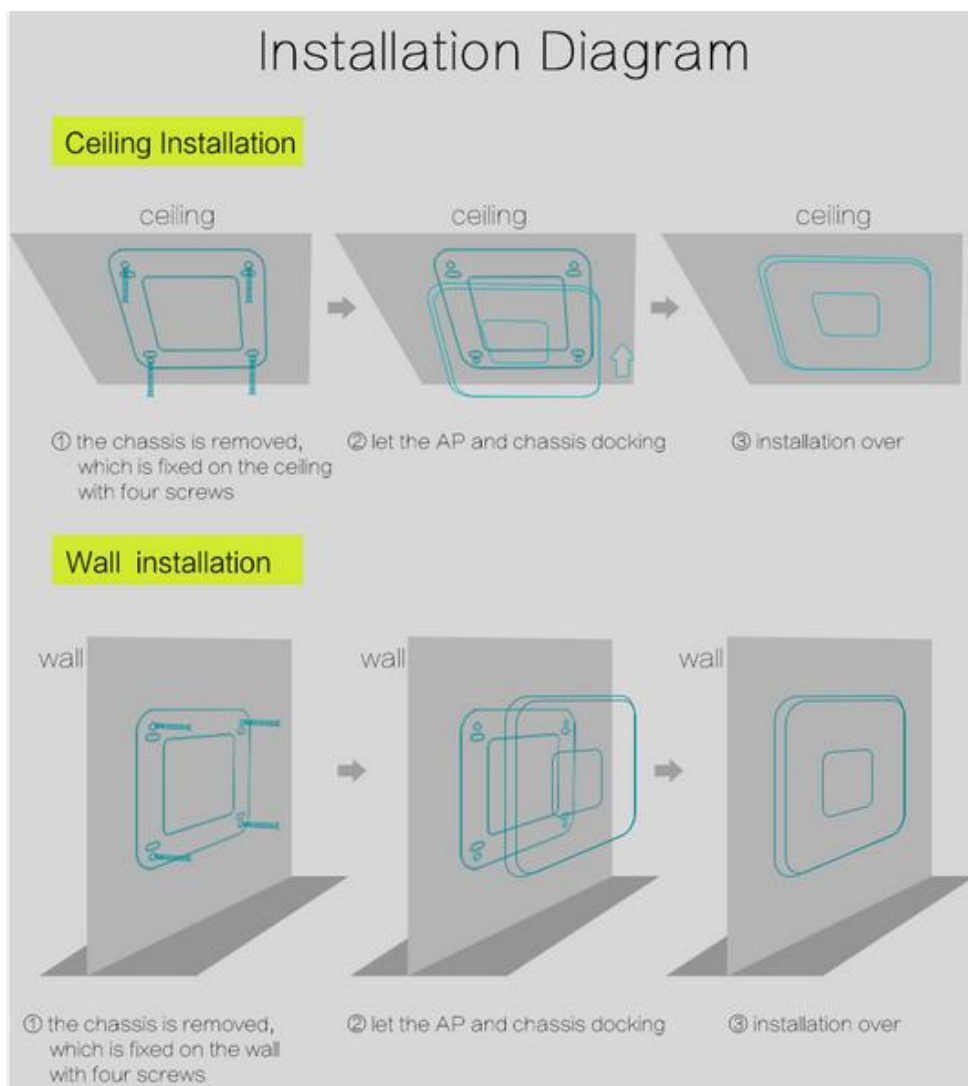

6.2.2 Installation precautions

Ensure that the signal intensity displayed on the conference unit is 3 bars or higher, and the system signal is in the ideal state, if low in grid 3, it is necessary to change the installation position or add AP to strengthen the signal coverage.

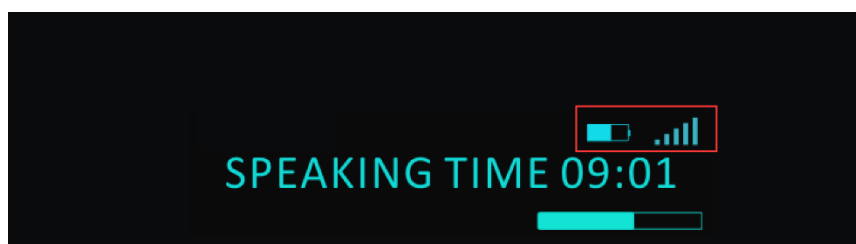

6.3 Connection

Connect the WAN/POE port (No.4 in Figure 6.3.1) of the AP to the AP port of the conference controller. If want to change SSID of the AP, connect a PC to the LAN port (No.2 in Figure 6.3.1) of the AP.

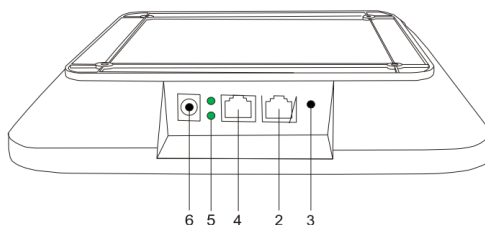

Figure 6.3.1 Network ports of the AP

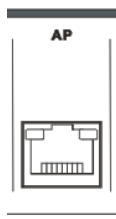

Figure 6.3.2 Network port of the conference controller

6.4 Settings and usage

6.4.1 Changing the AP channel

6.4.1.1 Connection

1. Connect the WAN/POE port of the AP to the AP port of the conference controller. Connect the LAN port of the AP to the network port of the PC.

VIS-DCP2000-W

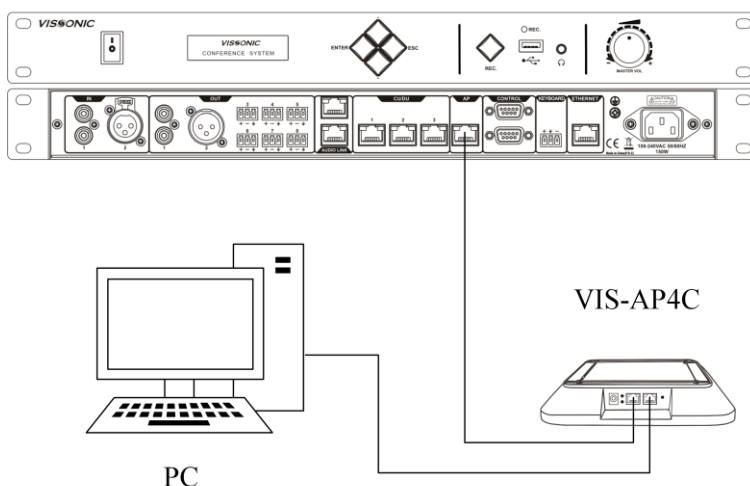

- Open "Windows Settings" on the PC, select "Network & Internet", click "Change adapter options", right-click the Ethernet icon, and then click "Properties". In the "Ethernet Properties" dialog box, select "Internet Protocol Version 4 (TCP/IPv4)", and then click the "Properties" button. Because the default IP address of the AP is 192.168.2.1, set an IP address in the same network segment as the AP for the PC, for example, 192.168.2.13, as shown in the following figure:

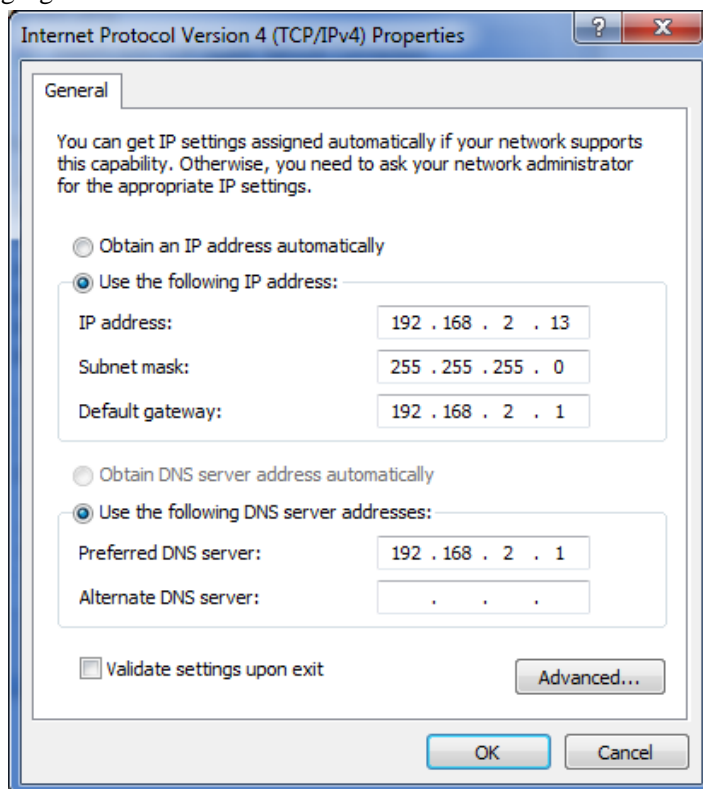

6.4.1.2 Configuration on Web page

1. Open the browser on the PC, enter the IP address 192.168.2.1 in the address bar, press Enter to log in to the AP.
2. On the login page, enter the password "admin" and click "Login".

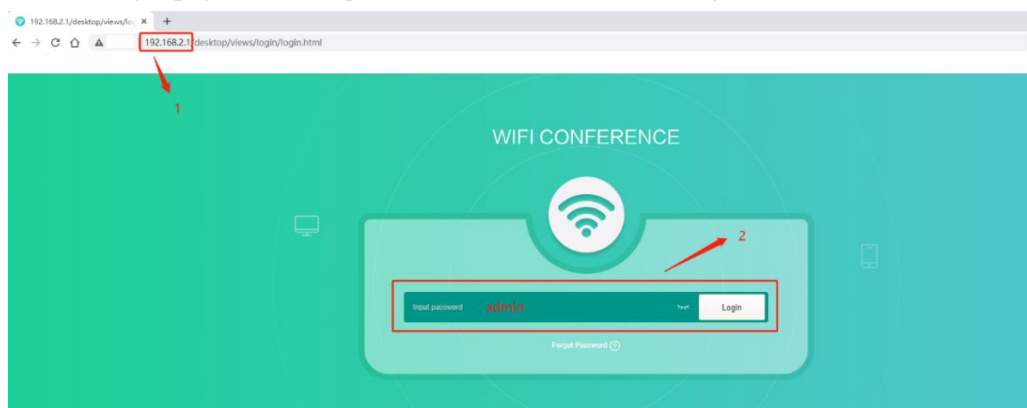

3. After login to the home page, click "WIFI" in the left navigation pane.
4. On the "WIFI" page, click "5G WIFI". The "Channel" field shows that the current AP (WIFI_CONFERENCE) occupies channel 48.
5. Click WIFI Analyzer, as shown in the following figure.

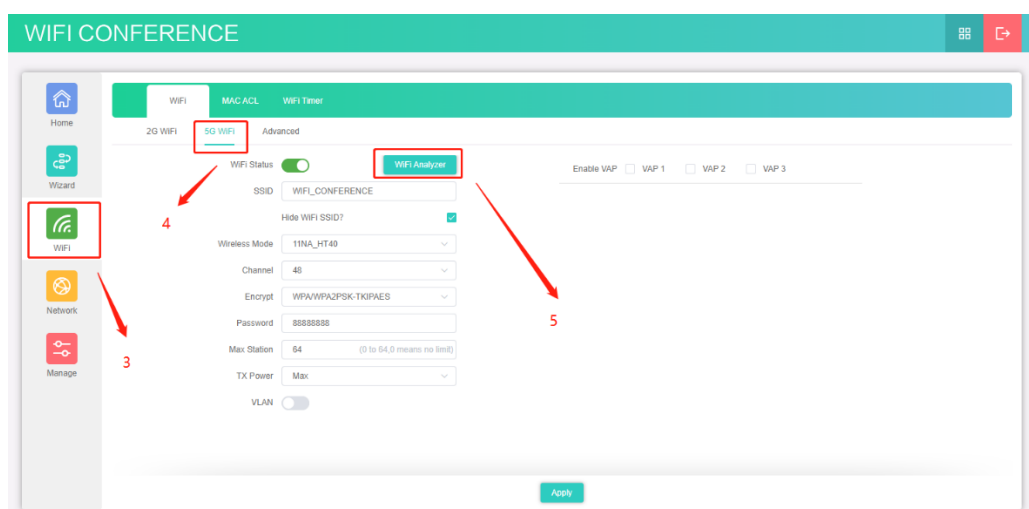

6. Click the "Refresh" button multiple times. Check the usage of 5G signals on site, including channel 48 occupied by the current AP and the other 5G channels occupied by other APs.

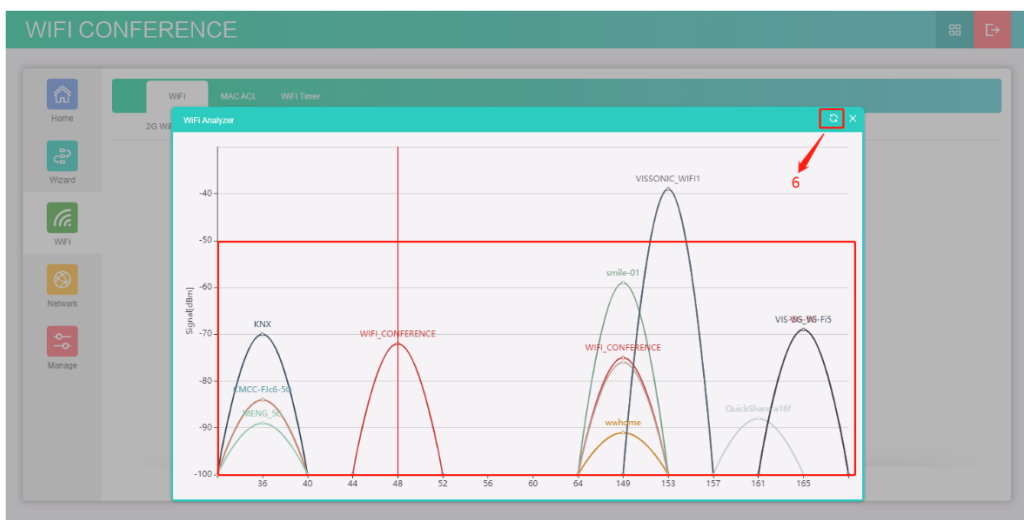

7. Click the "Close"  button. Click "Advanced" and then select an unused channel. An unused channel from channels 36 to 64 or channels 149 to 165 can be used in the system.
8. After selecting a channel, click "Apply".

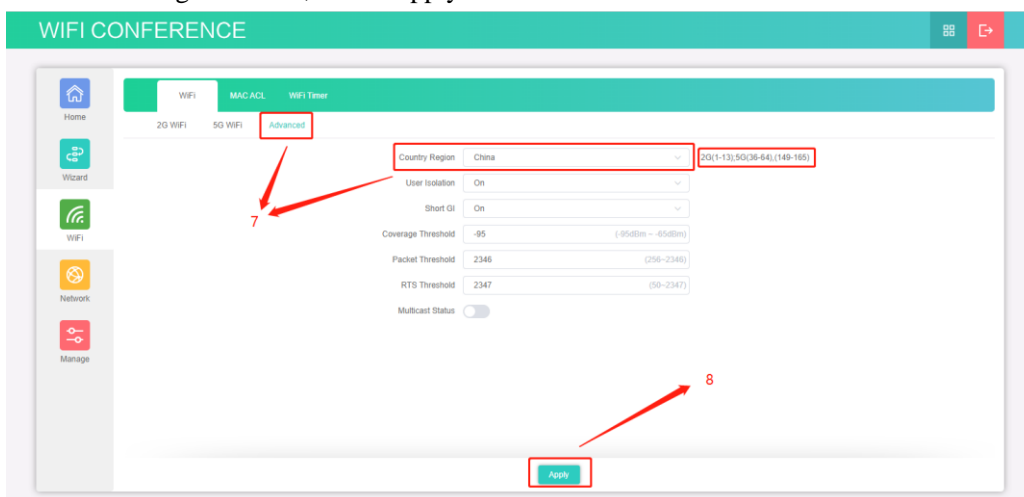

9. Click "5G WIFI" to return to the "5G WIFI" page, select the channel from "Channel", and then click "Apply".

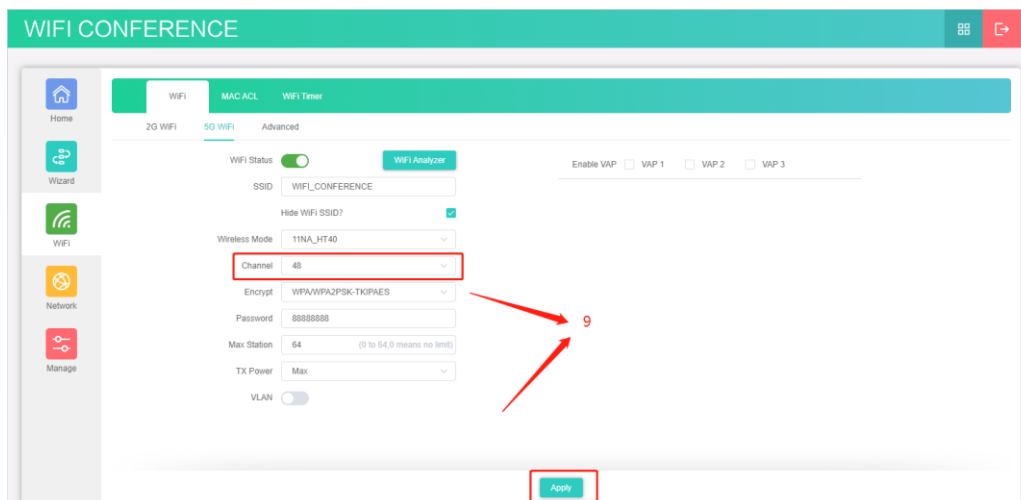

10. Disconnect the AP from the PC. The channel of the AP is changed.

6.4.2 Changing the SSID and password

When multiple wireless conference systems are used in the same building, need to set different SSIDs for these conference systems.

1. Set the "WiFi" menu on the conference controller to change the SSID and password and send the new SSID and password to all conference units.
2. Log in to the AP and change the SSID and password of the AP. The connection method is similar to that for changing the AP channel. For details, see Section 6.4.1.1.

Note: When a VIS-MAW-T wireless unit is connected in the wireless conference system, add a number (1, 2, or 3) after the new name if change the SSID. For example, WIFI_ROOM, WIFI_ROOM1, WIFI_ROOM2, and WIFI_ROOM3 correspond to conference room 1, 2, 3, and 4 in the menu of the VIS-MAW-T unit respectively.

6.4.2.1 Changing the SSID and password of wireless conference system

The SSID and password of the wireless conference system are modified in the "WiFi" menu of the conference controller, which includes the submenus "SSID", "PASSWORD", and "Start Set", as described in the following table.

Menu item	Parameter/Value	Description
-----------	-----------------	-------------

SSID	16 bits	16 bit SSID. Default is WIFI_CONFERENCE.
PASSWORD	8 bits	8 bit password of SSID. Default is 88888888.
Start Set	On/Off	<p>Command used to start the setting, which is set to Off by default.</p> <p>If change SSID and Password on the conference controller, need to set this command to On so as to send the new SSID and Password information to wireless conference units. An update success message is displayed when units receives the information. Be sure to set this parameter to Off after all units are successfully updated with the new SSID and password.</p> <p>Note: After wireless conference units updates the SSID and password, need to restart the units manually. The units cannot connect to the conference controller only after log in to the VIS-AP4C AP and change the SSID and Password accordingly.</p>

For example, to change the SSID to "WIFI_VISSONIC" and password to "88888888", perform the following steps:

1. Press "ENTER" to enter the "Menu" screen from the home screen. Then press "▼" to scroll down and locate the "Wifi" submenu.



2. Press "ENTER" to enter the "Wifi" submenu. Then press "▼" to scroll down. The "SSID", "PASSWORD", and "Start Set" submenus are displayed in order.



3. Set the SSID first. Press "ENTER" to enter the "SSID" submenu. Press "▼" or "▲" to set the current character and then press "ENTER" to activate the next character. Repeat this operation until the SSID is modified to "WIFI_VISSONIC". Then press "ESC" to exit the setting.



4. Set the PASSWORD. Press "ENTER" to enter the "PASSWORD" submenu. Perform the operations similar to those for changing the SSID until the password is modified to "88888888". The press "ESC" to exit the setting.



5. Make sure that all wireless conference units are turned on and in operating state. Press "ENTER" to enter the "Start Set" submenu. Press "▼" to locate "On" and then press "ENTER". The screen displays "Start set:On", as shown in the following figure. The conference controller sends the SSID and PASSWORD set in Step 3 and Step 4 to the wireless conference units. A "updated successfully" message is displayed when a wireless conference unit receives the information successfully.

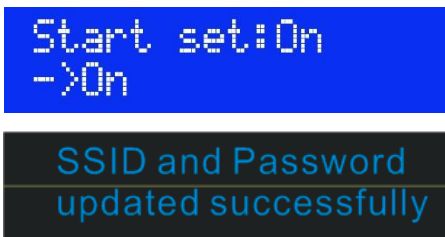

6. After all wireless conference units shows update success, press "▲" in the "Start Set" submenu to locate "Off" and then press "ENTER". The screen displays "Start set:Off", as shown in the following figure. Then restart all wireless conference units manually. These wireless conference units will prompt a connection failure and attempt to reconnect to the controller continuously. Need to update the SSID and PASSWORD of the AP for successful reconnection. For operation details, see Section 6.4.2.2.



6.4.2.2 Changing the SSID and password of AP

1. Connect a PC to the AP and then change the IP network segment of the PC to the same segment as the AP. For operation details, see Section 6.4.1.1. Open the browser on the PC and

enter the default IP address 192.168.2.1 of the AP. The following page is displayed.

2. Enter the password "admin" and click "Login".

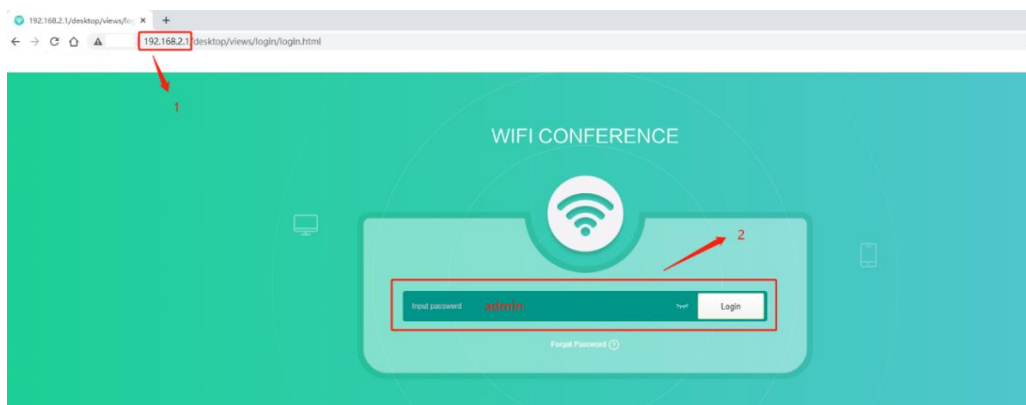

3. Click "WIFI" in the left navigation pane and then click "5G WIFI" to enter the "5G WIFI" page. The default SSID "WIFI_CONFERENCE" is displayed, as shown in the following figure. Change the SSID to the same one set on the controller, for example, "WIFI_VISSONIC". You can select "Hide WiFi SSID?" to hide the SSID. Set the wireless network password in "Password" and click "Apply" at bottom of the page. Wait for 15 seconds until the new settings are uploaded and saved. The setting is complete.

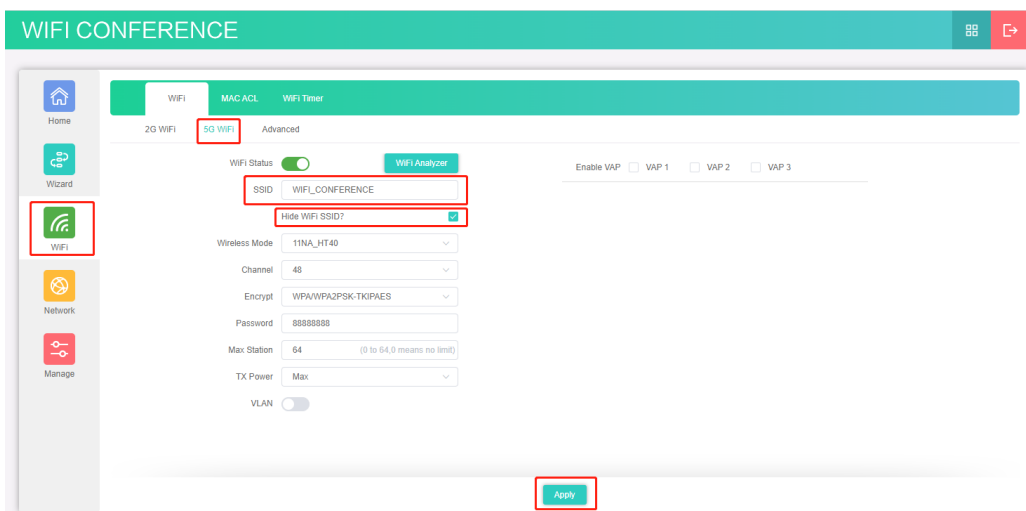

6.4.3 Restoring to factory settings

Press the Reset button on the rear panel of the AP for about 10 seconds and then release the button. Then press the Reset button again and release the button until the indicator lights off. The AP is restored to factory settings.

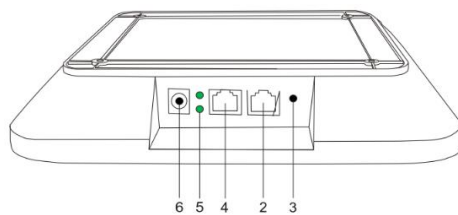

Figure 6.4.3 Ports on the side of VIS-AP4C

Note: It is not recommended to connect other devices to the POE switch. It should connect the VIS-DCP2000-W and up to 8 VIS-AP4C.

7. System connection and use case

7.1 System planning

Before using CLEANCON conference system, there are some basic points to plan/design a conference room.

The conference controller is powered by 110V-220V wide range power supply, while it has a basic control capacity (with VIS-EXM it can load more units). Here list a basic capacity of active units for one conference controller.

CLEANCON series conference system capacity table											
Model	Extension cable (m)	VIS-DCP2000-D/W				VIS-EXM					
		CU/ DU1	CU/ DU2	CU/ DU3	Max. total	CU/ DU1	CU/ DU2	CU/ DU3	CU/ DU4	Max. total	
VIS-DCC-T	2m	30	30	30	90	30	30	30	30	120	
VIS-DCD-T		VIS-DIC-T	5m	29	29	29	87	29	29	29	116
VIS-DID-T	VIS-DVC-T	10m		28	28	28	84	28	28	28	112
VIS-DVD-T	VIS-DSC-T		20m	24	24	24	72	24	24	24	96
VIS-DSD-T	VIS-DCC-F	50m		20	20	20	60	20	20	20	80
VIS-DCC-F	VIS-DCD-F		100m	15	15	15	45	15	15	15	60
VIS-FFC-F1	VIS-FFD-F1	2m		25	25	25	75	25	25	25	100
VIS-FFC-F2	VIS-FFD-F2		5m	24	24	24	72	24	24	24	96
VIS-MAU-T	VIS-MAW-T			10m	23	23	23	69	23	23	23
VIS-DMD-T			20m		19	19	19	57	19	19	19

	50m	15	15	15	45	15	15	15	15	60
	100m	10	10	10	30	10	10	10	10	40

The capacity is decided by:

1. Number of active conference units in the system.
2. Length of extension cable from the first conference unit to the VIS-DCP2000-D/W, or the first conference unit to the VIS-EXM.

Note: Extension cable has direct effect on the control capacity. The longer extension cable is used, the less power is available to drive the devices connected in the system. The length of the cable needs to be selected according to the practical situation.

7.2 System connection

The CLEACON conference system has five connection modes:

- **Hand-in-Hand-Loop-Network.** This connection mode is an important feature of the CLEACON series conference system, making the system more stable and reliable. The failure of any unit or disconnection of a cable does not affect the other units. Both CU/DU ports communicate and supply power to the unit.

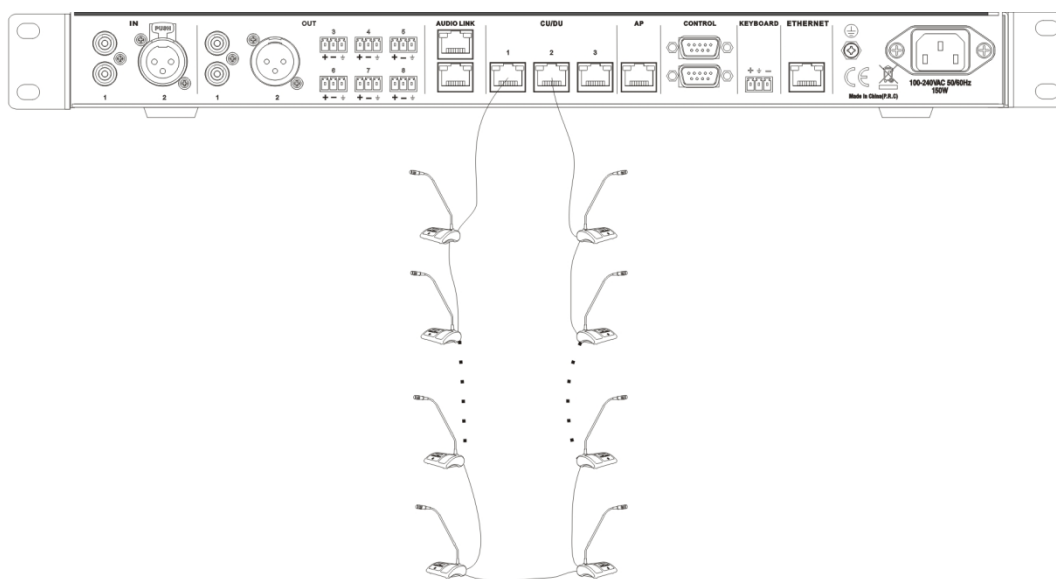

 "Hand-in-Hand-Loop-Network" connection is only available between CU/DU socket 1 and CU/DU socket 2, or CU/DU socket 2 and CU/DU socket 3. But it is not valid between CU/DU socket 1 and CU/DU socket 3.

● **Hand in Hand Connection**

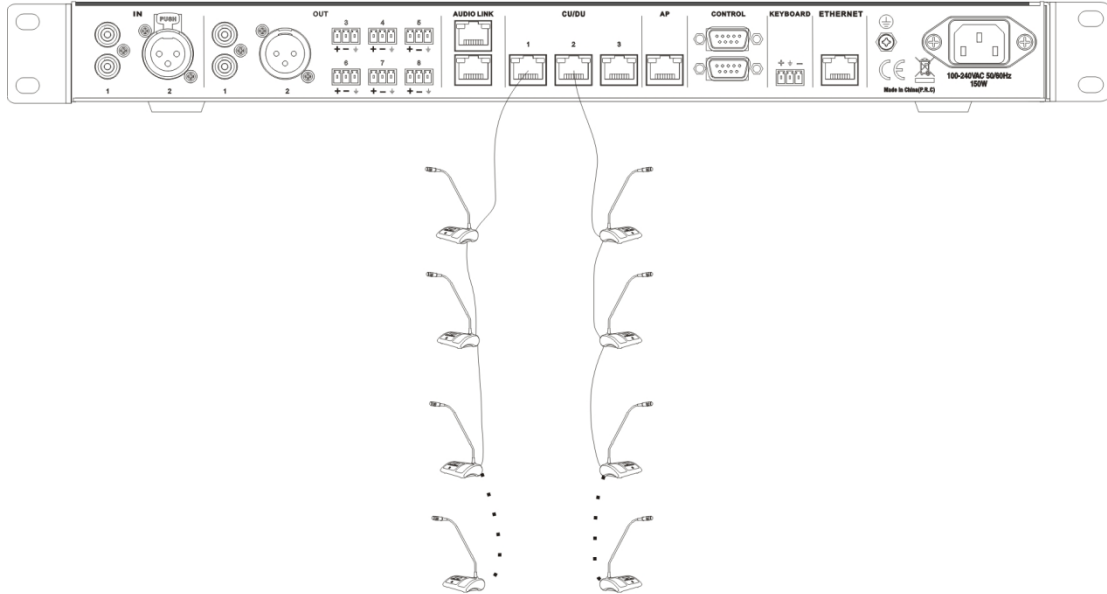

● **Hand-in-Hand connection Hand-in-Hand-Loop connection**

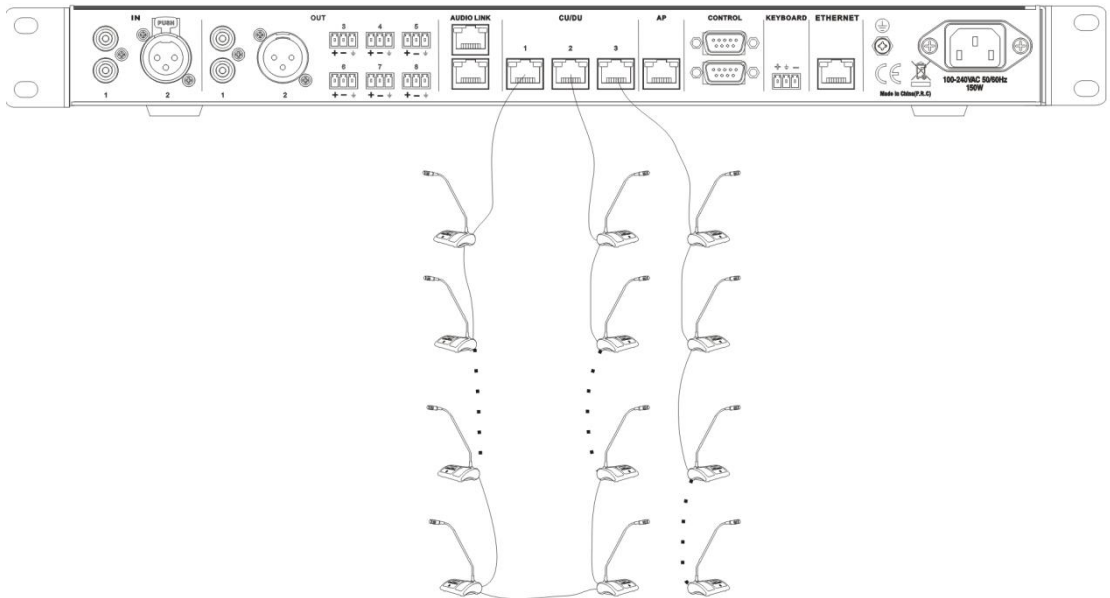

● **Extension main unit VIS-EXM + Hand-in-Hand-Loop connection**

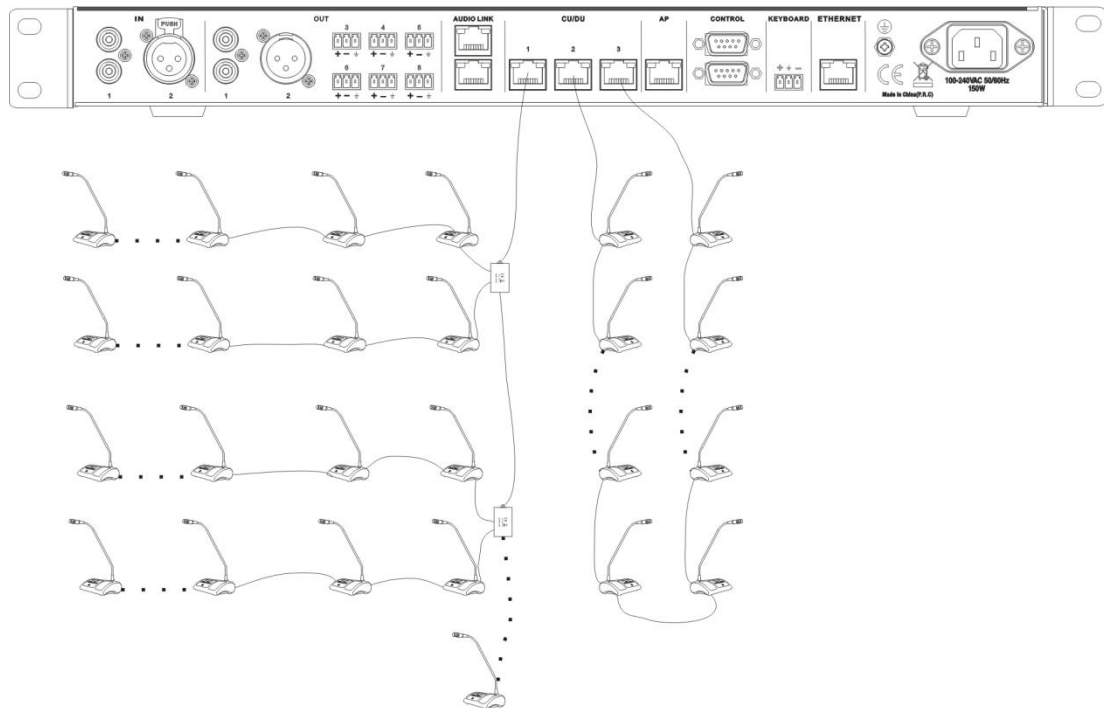

● **Extension main unit connection**

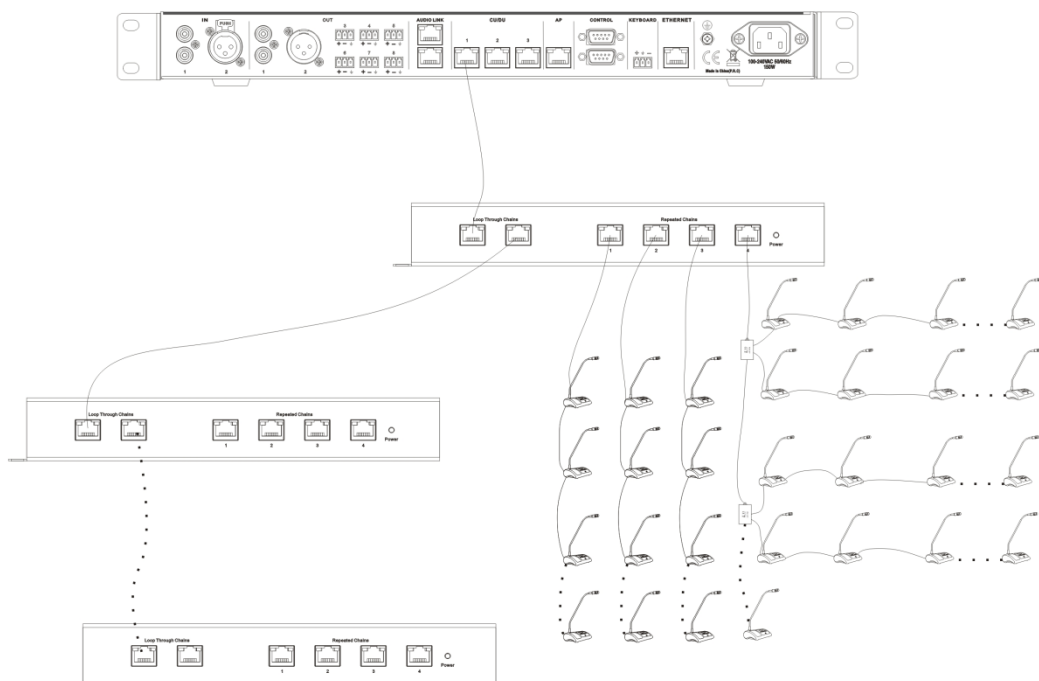

7.3 Use case

Under the default settings of the conference controller, unit and AP, generally there is no need to configure. After the system is connected, the conference system can already be used. The current time can be displayed on the unit. After the controller is connected to the audio system, there will be sound output.

The following is an example of a simple wired conference system that consists of a VIS-DCP2000-D conference controller, eight VIS-DCD-T delegate units, and two VIS-DCC-T chairman units. The connection diagram is as follows:

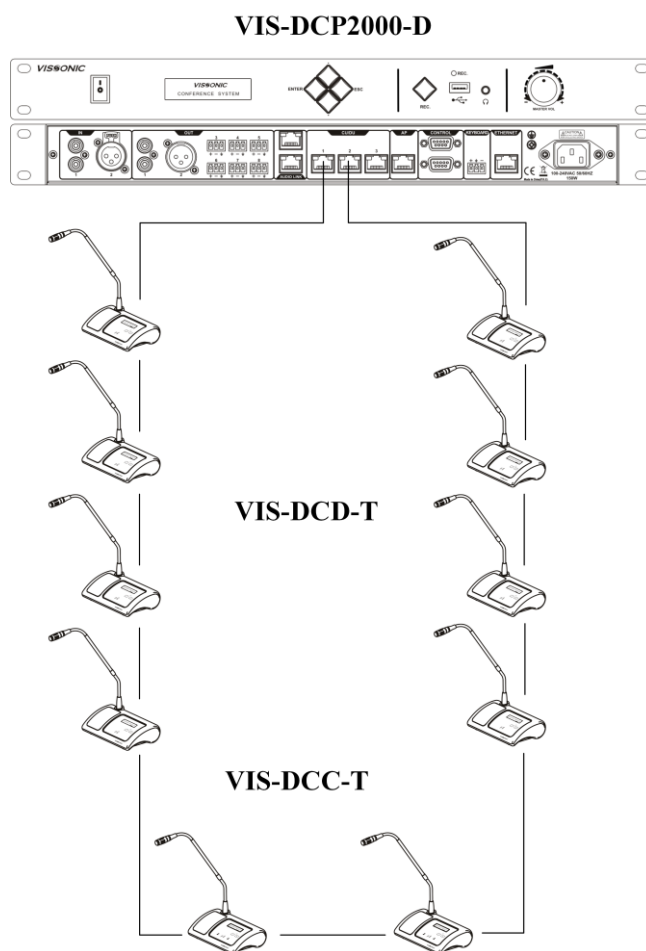

1. Turn the volume knob of the conference controller, control the output gain, and cooperate with the peripherals to get the required sound pickup distance on the premise of avoiding howling.
2. Set the "MIC mode" to "Open" and set the "Active MIC" to "1" of the controller menu. For the other settings, see the corresponding sections in this manual.

Note:

- If replace or add a conference unit, the new unit needs to reset the ID. See Section 3.1.3.
- For a wireless conference system, determine whether to change the AP channel according to the wireless network environment on site. See Section 6.4.1.
- If multiple wireless conference systems are used in the same building, need to set a unique SSID for each system. See Section 6.4.2.

8. Technical specifications

8.1 Camera tracking protocol

Format: A0 [XX] 10 00 07 [YY] FF FF FF AF [ZZ]

1. Explain: [XX], [YY], [ZZ] are all hexadecimal, where [YY] represents ID code.
2. Algorithm: [ZZ] = 0xFFFF - ([xx]+10+00+07+[YY]+FF+FF+FF), result low.
3. The conference unit ID starts from 1 and increases progressively.
4. Use the "256 base system", for example ID 256, [YY] = 00, [XX] plus 1.

As shown in the table below:

Conference unit ID (in decimal); Serial port code (conference controller serial port common, protocol set to "CUSTOM", in hexadecimal)

0 A0 10 10 00 07 00 FF FF FF AF DB (Panorama code, all microphones are off)

1 A0 10 10 00 07 01 FF FF FF AF DA

2 A0 10 10 00 07 02 FF FF FF AF D9

3 A0 10 10 00 07 03 FF FF FF AF D8

4 A0 10 10 00 07 04 FF FF FF AF D7

...

127 A0 10 10 00 07 7F FF FF FF AF 5C

128 A0 10 10 00 07 80 FF FF FF AF 5B

256 A0 11 10 00 07 00 FF FF FF AF DA

257 A0 11 10 00 07 01 FF FF FF AF D9

258 A0 11 10 00 07 02 FF FF FF AF D8

259 A0 11 10 00 07 03 FF FF FF AF D7

260 A0 11 10 00 07 04 FF FF FF AF D6

....

512 A0 12 10 00 07 00 FF FF FF AF D9

513 A0 12 10 00 07 01 FF FF FF AF D8

514 A0 12 10 00 07 02 FF FF FF AF D7

515 A0 12 10 00 07 03 FF FF FF AF D6

516 A0 12 10 00 07 04 FF FF FF AF D5

...

768 A0 13 10 00 07 00 FF FF FF AF D8

769 A0 13 10 00 07 01 FF FF FF AF D7

770 A0 13 10 00 07 02 FF FF FF AF D6

771 A0 13 10 00 07 03 FF FF FF AF D5

772 A0 13 10 00 07 04 FF FF FF AF D4

8.2 Devices

8.2.1 VIS-DCP2000-D

Power	AC 100V-240V
Static power consumption	12W
Maximum power consumption	150W
Frequency Response	20Hz-20KHz
Noise ratio (S/N)	> 96dBA
Total harmonic distortion	< 0.05%
Channel Crosstalk	> 85dB
Dynamic range	> 94dB
RS232 control	1×9-pole Sub-D female socket 1×9-pole Sub-D male socket
Ethernet control	RJ45 connected to PC
Mounting	19" standard rack
Dimensions (mm)	483L × 260W × 43.6H
Weight	3kg
Max. audio inputs	LINE IN 1: +10dBu LINE IN 2: +10dBu
Max. audio outputs	LINE OUT 1: +12dBu BAL LINE OUT 2: +12dBu BAL LINE OUT 3: +12dBu BAL LINE OUT 4: +12dBu BAL
Output impedance	> 1kΩ
PC communication method	TCP/IP
Camera control method	RS232/UDP
Network Interface	RJ45
Display	LCD1602
Limit on the number of active MIC	1/2/4/6
Camera Tracking Protocol	PELCO-P/PELCO-D/VISCA
Operating temperature	0°C-45°C
Storage temperature	20°C-50°C

8.2.2 VIS-DCP2000-W

Power	AC 100V-240V
Static power consumption	12W
Maximum power consumption	150W
Frequency Response	20Hz-20KHz
Noise ratio (S/N)	> 96dBA
Total harmonic distortion	< 0.05%
Channel Crosstalk	> 85dB
Dynamic range	> 94dB
RS232 control	1×9-pole Sub-D female socket 1×9-pole Sub-D male socket
Ethernet control	RJ45 connected to PC
Mounting	19" standard rack
Dimensions (mm)	483L × 260W × 43.6H
Weight	3kg
Max. audio inputs	LINE IN 1: +10dBu
	LINE IN 2: +10dBu
Max. audio outputs	LINE OUT 1: +12dBu BAL
	LINE OUT 2: +12dBu BAL
	LINE OUT 3: +12dBu BAL
	LINE OUT 4: +12dBu BAL
Transmission technology	WIFI 802.1n
Encryption technology	WPA2-PSK AES
Working frequency	5.2-5.8GHz
Output impedance	> 1kΩ
PC communication method	TCP/IP
Camera control method	RS-232/UDP
Network Interface	RJ45
Display	LCD1602
Limit on the number of active MIC	1/2/4
Camera Tracking Protocol	PELCO-P/PELCO-D/VISCA
Operating temperature	0°C-45°C
Storage temperature	20°C-50°C

8.2.3 VIS-

DCC/DCD/DVC/DVD/DVCIC/DVDIC/DIC/DID/DSC/DSD-T

Button	Touchable interface
Sound Pickup	heart type capacitance
Display	OLED display 128 × 32
Sensitivity	-46 dBV/Pa
Maximum power consumption	2.0W
Directivity	0°/180°> 20 dB (1 KHz)
Headphone load	16Ω
Headphone volume	10mW
Headphone jack	3.5mm stereo
Input impedance	2kΩ
SNR	70dB
Frequency response	20-20KHz
Connection	CAT5/CAT6 cable + snap
Equivalent noise	20dBA (SPL)
Main material	ABS
The maximum sound pressure	125dB (THD<3%)
Weight	1.1kg (with microphone)
Dimension	195L × 120W × 60H mm (without microphone)
Operating temperature	0°C to + 55°C
Color	Black

8.2.4 VIS-DMD-T

Screen size	109.22 mm (5.0 inches)
Resolution	800 × 480
Screen type	Capacitive multi-touch
Contactless NFC cards in following standards	ISO/IEC14443 Type A
Connection method	CAT5/CAT6 cable + buckle
Electrical parameters	
Power	48V DC
Supply consumption	5 W
Frequency response	20Hz-20KHz

THD at rated level	< 0.1%
Dynamic range	> 90 dB
SNR	> 90 dB
Audio input	
Nominal microphone input	80 dB SPL in accordance with IEC60914
Maximum sound pressure	125dB (THD < 3%), in line with IEC60914
Sensitivity	-46 dBV/Pa
Audio output	
Headphone load	16Ω
Headphone volume	10mW
Headphone port	3.5mm stereo socket. Input impedance 2kΩ
Mechanical parameter	
Installation: desktop	Desktop
Dimensions (mm, without microphone)	160L × 100W × 65H
Color	Black
Weight	0.7KG (base)
Environmental parameters	
Operating temperature	5°C to +55°C
Relative humidity	< 90%

8.2.5 VIS-MAU-T

Screen size	109.22 mm (4.3 inches)
Resolution	800 × 480
Screen type	Capacitive and color multi-touch
Contactless NFC cards in following standards	ISO/IEC14443 Type A
Connection method	CAT5 / CAT6 cable
Sound Pickup	Heart type capacitance
Power	DC 48V
Power consumption	3.4W
Frequency response	20Hz-20KHz
THD at rated level	<0.1%
Dynamic range	>90dB
SNR	≥96dB
Audio input	
Nominal microphone input	80 dB SPL in accordance with IEC60914
Maximum sound pressure	125dB (THD <3%), in line with IEC60914
Sensitivity	-46 dBV/Pa
Audio output	

Headphone load	16Ω
Headphone volume	10mW
Headphone jack	3.5mm stereo
Input impedance	2kΩ
Mechanical parameter	
Installation	Desktop
Dimensions (mm, without microphone)	217.5L × 138.5W × 69H
Color	Black
Main material	ABS
Weight (without microphone)	1.0 KG
Environmental parameters	
Operating temperature	5°C to +55°C
Relative humidity	<90%

8.2.6 VIS-DAC/DAD-T

Button	Touchable interface
Sound Pickup	Up to 120CM
Maximum power consumption	1.0W
Headphone load	16Ω
Headphone volume	10mW
Headphone jack	3.5mm stereo
Input impedance	2kΩ
SNR	70dB
Frequency response	20Hz–20KHz
Connection	CAT5/CAT6 cable + RJ45
Equivalent noise	20dBA (SPL)
Main material	Aluminum
Weight	0.7kg
Dimension	305L × 45W × 42H (mm)
Operating temperature	0°C to + 55°C
Color	Silver or Black

8.2.7 VIS-DCC/DCD/CSU/DVU/SPK/FFC/FFD-F/FS/FS1/FS2/F1/F2

Button	Touchable interface
Sound Pickup	Heart type capacitance
Sensitivity	-46 dBV/Pa

VIS-FFD/FFC-F1/F2 display	OLED 128 × 32
Maximum power consumption	VIS-DCD/DCC/FFD/FFC-F/F1/F2: 2.0W; VIS-CSU-F: 1.8W; VIS-SPK-F: 3W.
Directivity	0°/180°> 20dB (1 KHz)
Headphone load	16Ω
Headphone volume	10mW
Headphone jack	3.5mm stereo
Input impedance	2kΩ
SNR	70dB
Frequency response	20Hz-20KHz
Equivalent noise	20dBA (SPL)
Connection	CAT5/CAT6 cable + RJ45
Main material	Aluminum
The maximum sound pressure	125dB (THD<3%)
Weight	VIS-DCD/DCC-F: 0.6kg (with microphone); VIS-CSU/DVU-F/FS1/FS2: 0.2kg; VIS-FFD/FFC-F1/F2: 1.1kg (with microphone).
Dimension(mm)	VIS-DCD/DCC/CSU/DVU-F/FS1/FS2: 100L × 40W × 65H (without microphone); VIS-SPK-F: 100L × 40W × 30H; VIS-FFD/FFC-F1/F2: 265L × 85W × 72H (without microphone).
Operating temperature	0°C to + 55°C
Color	Black
Drill hole size	VIS-DCD/DCC/CSU/DVU/SPK-F/FS1/FS2: 93×33 mm (One Unit); 193×33 mm/93×33 mm+middle distance 41 mm (Two Combined Unit); 293×33 mm (Three Combined Unit). VIS-FFD/FFC-F1/F2: 248×76 mm.

8.2.8 VIS-WDC/WDD/WVC/WVD/WVCIC/WVDIC-T

Button	Touchable interface
Sound Pickup	Heart type capacitance
Display	OLED 128 × 32
Sensitivity	-46 dBV/Pa
Maximum power consumption	2.0W

Directivity	0 °/180 ° > 20dB (1 KHz)
Headphone load	16Ω
Headphone volume	10mW
Headphone jack	3.5mm stereo
Input impedance	2kΩ
SNR	70dB
Frequency response	20Hz-20KHz
Equivalent noise	20dBA (SPL)
Main material	ABS
Operating temperature	0°C to + 55°C
Color	Black
The maximum sound pressure	125dB (THD <3%)
Weight	1.1kg (with microphone)
Dimension	195L × 120W × 60H mm (without microphone)

8.2.9 VIS-MAW-T

Screen size	109.22 mm (4.3 inches)
Resolution	800 × 480
Screen type	Capacitive and color multi-touch
Contactless NFC cards in following standards	ISO/IEC14443 Type A
Connection method	CAT5/CAT6 cable + WiFi wireless + buckle
Sound Pickup	Heart type capacitance
Power	DC 48V
Power saving mode consumption	1.4W
Maximum power consumption	3.8W (connection with wireless and wired together)
Frequency response	20Hz-20KHz
THD at rated level	< 0.1%
Dynamic range	> 90dB
SNR	≥ 96dB
Audio input	
Nominal microphone input	80 dB SPL in accordance with IEC60914
Maximum sound pressure	125dB (THD < 3%), in line with IEC60914
Sensitivity	-46 dBV/Pa
Audio output	
Headphone load	16Ω
Headphone volume	10mW
Headphone jack	3.5mm stereo
Input impedance	2kΩ

Mechanical parameter	
Installation	Desktop
Dimensions (mm, without microphone)	217.5L × 138.5W × 69H
Color	Black
Main material	ABS
Weight (without microphone)	1.0 KG
Environmental parameters	
Operating temperature	5°C to +55°C
Relative humidity	< 90%

8.2.10 VIS-WBTY1

Battery capacity	4900mA
Output voltage	7.2V DC
Weight	285g
Operation temperature	-20°C-60°C
Full charge time	Four hours needed to fully charge
Battery life	24 hours (MIC on continuously)

8.2.11 VIS-WCH1

Input	100-240V, AC, 50-60Hz
Output	7.2V, 1000mA
Power consumption	20W
Dimension	320L × 200W × 50H (mm)
Weight	2KG
Full charge time	Four hours needed to fully charge
The number of batteries charged at one time	8 pcs VIS-WBTY1 at one time

8.2.12 VIS-WBTY2/VIS-WBTY2-H

Battery capacity	VIS-WBTY2: 5000mAh; VIS-WBTY2-H: 6500mAh.
Output voltage	DC 7.2V
Weight	240g

Operation temperature	-20°C-60°C
Full charge time	Four hours needed to fully charge
Battery life	20 hours (with power save mode); 14 hours (MIC on and screen is highlighted continuously).

8.2.13 VIS-WCH2

Input	100-240V, AC, 50-60Hz
Output	7.2V, 1000mA
Power consumption	20W
Dimension	530L×200W×52H (mm)
Weight	2kg
Full charge time	Four hours needed to fully charge
The number of batteries charged at one time	10 pcs VIS-WBTY2 at one time

8.2.14 VIS-INT64

Power	DC 48V from controller or adaptor
Power consumption	3W
LCD	320 × 64 dot (blue white)
Microphone	
Transducer	Electret-condenser
Polar pattern	Uni-directional
Sensitivity	-46dBV/pa
Frequency response	20Hz-20KHz
Input impedance	2.2kOhm
Headphone	
Frequency Response	30-20KHz
Headphone load	> 8ohm
Headphone volume	10mW
Directivity 0°/180°	> 20 dB (1KHz)
Equivalent noise	20 dBA (SPL)
Maximum sound pressure level	125 dB (THD<3%)
Mechanical	
Dimension (mm)	280H × 128W × 55D
Weight	1.5kg

8.2.15 VIS-EXM/VIS-CNB/VIS-AP4C

● VIS-EXM

Power	48V, DC, 3A
Dimension (mm)	223W × 37H × 92D
Weigth	0.5KG

● VIS-CNB

Interface	2×RJ45 loop ports; 2×RJ45 for repeated chains ports.
Dimension (mm)	80L × 50W × 23H
Weigth	0.1KG

● VIS-AP4C

WLAN Standard	IEEE802.11ac, IEEE802.11a, IEEE802.11g, IEEE802.11b
RF Frequency Bands	5GHz UNII
Max Transmission Power	27dBm
Antenna Type	Four built-in 5dBi antennas
Supply Type	Power Over Ethernet, 802.3at, DC 12V 1.5A
Supply Voltage (at Power Consumption)	≤13W
Interface	1×Gigabit WAN/POE Port, 1×Gigabit LAN Port
Link Speed	1200Mbps
Networking Addressing Capability	DHCP or Manual IP address
Cable Length	100m (max)
Cable Type	≥ Cat5e (shielded/unshielded)
Connector Type	1× RJ45
Connector LED	WAN/POE Port (UP LED), LAN Port (Down LED)
Dimension (mm)	220L×220W×45H
Color	White
Weight	0.3KG
Mounting Type	Ceiling, Wall or Stand Rack