



# VIS-NP Series Electronic Nameplate User Manual V1.0









VISSONIC Electronics Limited

# The indications of symbols

■ **Safety instructions**

Some symbols pointing out the potential risk of injury and property loss are used in the instructions and devices, to help you use the devices safely and properly. Symbols and their indications are as follows. Please make sure that you have known these instructions before reading the manual.

	Remind users to operate and maintenance according to the instructions attached to the devices. If ignoring this information, it may cause death or injury due to wrong operations.
	Remind users that uninsulated dangerous voltage in devices may lead to electric shock.
	CE certification means that the product has reached the safety requirements specified by EU regulations, users can be assured.
	SGS certification means that the product has reached the quality standards of the world's largest Societe Generale de Surveillance.
	This product has passed ISO9001 international quality certification (certification bodies: Rheinland TUV).
	WARNING: To avoid electric shock, do not open the cover, and do not place unnecessary portion in the chassis. Please contact qualified service personnel.

■ **General information indications**

	Information that may lead to an unsuccessful operation or setting and other relevant information needed to be noticed is listed.
---	--

## Important notes



### Warning

To ensure reliable use of devices and safety of personnel, please observe the following items in the installation, use and maintenance.

### Notes in installation

- ◆ Do not use this product in the following places: Where exists dust, smoke, conductive dust, corrosive gases or flammable gases; where exposes to high temperature, condensation or wind and rain; where exists vibration and shock. Electric shock, fire, incorrect operation will also lead to product damage and deterioration;
- ◆ During screw hole processing and wiring, metal chips and wire heads shall not be dropped into ventilation holes of controllers, which may cause a fire, malfunction or incorrect operation;
- ◆ When the installation work is done, make sure that no foreign body is left on the surface of ventilation, including contact paper and other packaging materials, otherwise it may lead to poor run-time heat, causing a fire, malfunction or incorrect operation;
- ◆ Avoid wiring or inserting/pulling plugs in charged state, otherwise it may easily lead to electric shock or cause damage to the circuit;
- ◆ Installation and wiring must be solid and reliable, poor contact may result in incorrect operation;
- ◆ For application in occasions with severe interference, shielded cables should be used to input and output high-frequency signal so that anti-interference performance of the system could be improved.

### Notes in wiring

- ◆ All of the external power supply must be cut off before carrying out installation, wiring and other operations, or it may cause electric shock or equipment damage;
- ◆ This product is grounded through the grounding conductor of the power cord. In order to avoid electric shock, the grounding conductor must be connected to earth. Before connecting the input or output terminals of the product, make sure that the product is properly grounded;
- ◆ Once wiring is completed, foreign matters should be immediately removed. Please cover the terminal covers of product before power connection to avoid electric shock;

### Notes in operation and maintenance

- ◆ Do not touch the terminal when power is on, or it may cause electric shock or incorrect operation;
- ◆ Perform cleaning and terminal tightening when power is off, for these operations may cause electric shock when power is on;
- ◆ Perform connection, removal or other operations of the communication signal cables and the cables of expansion board or control unit after power is off, or it may cause equipment damage or incorrect operation;
- ◆ Do not disassemble the equipment, so as not to damage the internal electrical components;
- ◆ Always read the manual, after security fully recognized, changing the program, commissioning, starting and stopping operations after security is fully recognized;
- ◆ Button batteries must be replaced when the power is off. When you indeed need to replace the button batteries with the power on, the operation should be performed by a qualified electrical technician wearing insulated gloves.

### Notes in product obsolescence

- ◆ Explosive electrolytic capacitors: It may cause explosion when electrolytic capacitor on the circuit board burns;
- ◆ Please collect and process separately, it cannot be put in the life garbage.
- ◆ Please process it as industrial waste, or process it in accordance with local environmental regulations.

# Preface

This manual mainly describes the use, performance parameters and troubleshooting of VISSONIC Ilang digital network DSP conferencing systems - including desktop, embedded, array, and 5GWiFi wireless conferencing systems.

The manufacturer will update the version number of the manual upon the change of technical parameters and system use. Please use the latest product manual.

VISSONIC Electronics Limited possesses the copyright of this manual. This manual is protected by the Copyright Law of the People's Republic of China and other intellectual property laws. No part or all of this manual may be copied or modified without permission.

Version	Description	Date
1.0	Released	2023-03-28

# Contents

<b>User Manual</b> .....	- 1 -
<b>V1.0</b> .....	- 1 -
VISSONIC Electronics Limited .....	- 1 -
Chapter One System overview .....	- 5 -
Chapter Two Devices .....	- 6 -
2.1 Conference controller .....	- 6 -
2.2 Features .....	- 6 -
2.3 Host panel introduction .....	- 7 -
2.4 Controller specifications .....	- 8 -
2.5 7" dual-screen electronic nameplate.....	- 9 -
2.6 Panel dimensions .....	- 10 -
2.7 Specifications of the 7-inch dual-screen electronic nameplate.....	- 11 -
2.8 10" dual-screen electronic nameplate.....	- 12 -
2.9 Panel dimensions .....	- 13 -
2.10 Specifications of the 10-inch dual-screen electronic nameplate .....	- 14 -
Chapter Three Software description .....	- 16 -
3.1 Configuration .....	- 16 -
3.2 Login .....	- 16 -
3.3 Login to the home page of the electronic nameplate conference system.....	- 17 -
3.5 User management .....	- 19 -
3.6 Nameplate binding.....	- 19 -
3.7 Terminal device .....	- 20 -
3.8 Nameplate template.....	- 20 -
3.9 Setting the nameplate template.....	- 21 -
3.10 Adding a conference room .....	- 22 -
3.11 Editing a conference room .....	- 23 -
3.12 Conference reservation .....	- 24 -
3.13 Conference preparation.....	- 26 -
3.14 Conference sign-in .....	- 27 -
3.15 Conference process .....	- 28 -
3.16 Suspend the conference .....	- 29 -
3.17 Archiving a conference.....	- 30 -

# Chapter One System overview

## ■ Overview

The VISSONIC conference software can control the conference controller through the LAN and achieve unit and electronic nameplate control. A single unit supports POE from 1 to 24 bits. The number and the scope of use can be expanded through POE switch expansion.

The VISSONIC management software is installed on the nameplate controller and allows local operation through the keyboard. The software can control the conference units, electronic nameplates, and voting units through the conference controller over the LAN. You can also use the VISSONIC management software to set advanced functions, manage conference discussions, manage recordings, and so on.

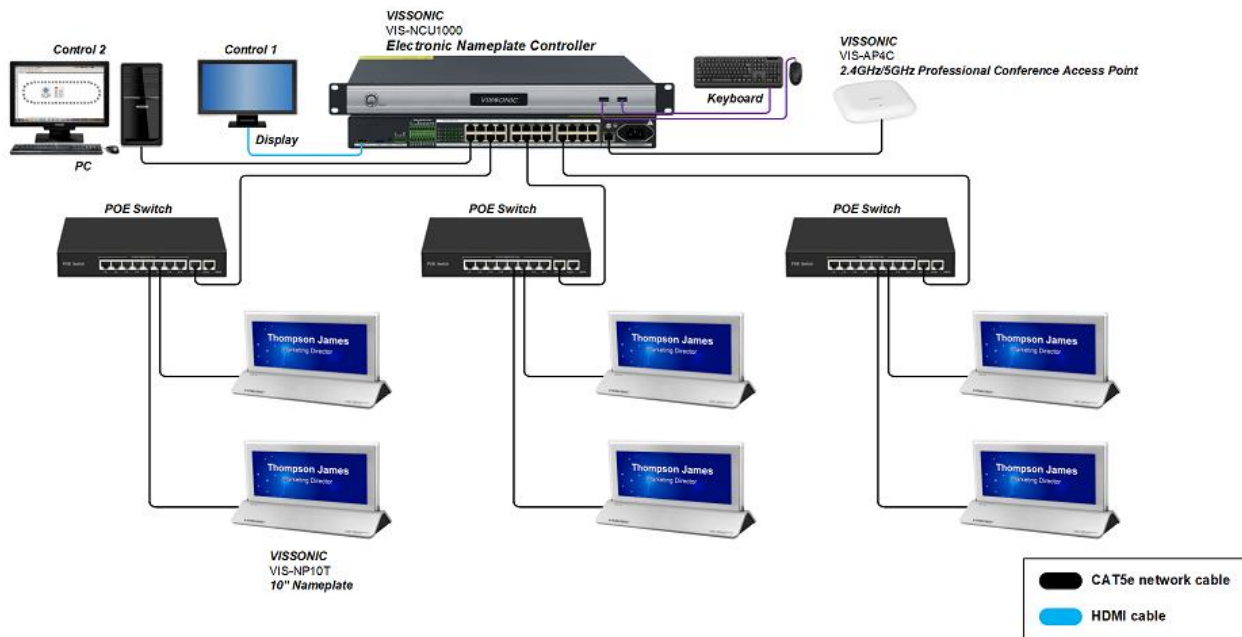

Figure 1.1 System diagram(Connection diagram Extended connection diagram of a POE switch)

**System composition:**

- ✓ Electronic Nameplate Controller VIS-NCU1000
- ✓ Control 1(Display)
- ✓ 2.4 GHz/5 GHz Professional Conference AP VIS-AP4C
- ✓ Keyboard
- ✓ Control 2(PC)
- ✓ CAT5e network cable
- ✓ HDMI cable
- ✓ POE Switch VIS-SWICH12
- ✓ 10"Nameplate VIS-NP10T

**NOTE:**

- ① 7" and 10" nameplate system connection in same methods
- ② Once the number of Nameplate exceeds 22, you need to use POE switches to expand the number and usage.

# Chapter Two Devices

## 2.1 Conference controller

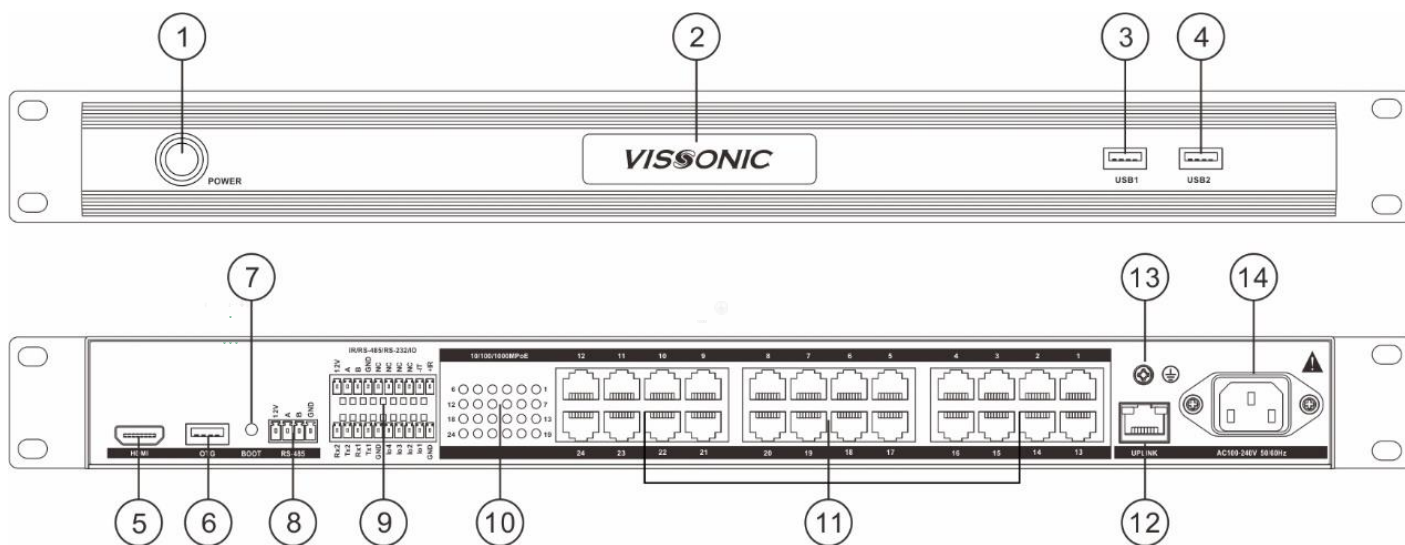

Figure 2.1 Controller diagram

## 2.2 Features

1. Supports 24 PoE power supplies, up to 13 W per port.
2. Supports the simultaneous online operation of up to five operators.
3. Supports local operations and operations performed on all kinds of browsers.
4. Allows you to connect the tablet PC to the management controller via Wi-Fi to quickly configure the nameplate information.
5. Supports USB mouse and keyboard connection, HDMI display output, as well as setting and modification of nameplate information through the software.
6. Provides ubiquitous wireless control.
7. Provides advanced function setting and control on-site.
8. Manages conference discussions, electronic nameplates, sign-in, audio recordings, and video recordings.
9. Creates conferences and schedules each seat in advance.

## 2.3 Host panel introduction



1. Power switch (with indicator) : Press down to "On", flip up to "off".
2. Host brand label.
3. USB1 port - Connects to a mouse and keyboard.
4. USB2 port - Connects the mouse and USB flash drive.
5. HDMI port - Connects to the monitor through an HDMI output port.
6. OTG interface - Used for engineering debugging
7. BOOT button - dedicated for engineering debugging.
8. RS485 port (reserved).
9. Multifunctional interface (reserved).
10. Network connection indicator - Identifies whether the network connection is successful.
11. RJ45 port - 24 100/1000 MBPS adaptive RJ45 ports that support standard POE power supply and can be used to connect to PCS and electronic tables.
12. UPLINK Ethernet port - The IP address of the port on the left is configured by default for connecting to the network.
13. Ground screw - Connects the processor unit to the ground
14. Power port - System power input. The switching power supply is AC100V to 240V 50/60Hz.



## 2.4 Controller specifications

Item	Specifications
Power supply interface	3C standard power supply interface
Uplink port	1 × uplink RJ45 interface
PoE	24 × RJ45 interfaces for PoE power supply
VO	4 × I/O Phoenix interfaces
IR	1 × IR Phoenix interface
RS-232	2 × IR Phoenix Interfaces
RS-485	2 × IR Phoenix Interfaces
Indicator	24 × status indicators
USB	X2
OTG	X1
HDMI	X1
BOOT	X1 button
Power switch	1 × power switch with indicator
Dominant frequency	2 G
Memory	16 G (eMMC)
RAM	2 G
Power supply	AC 100–240V 50/60 Hz
Dimension (mm)	483(L) × 180(W) × 44.5(H)

## 2.5 7" dual-screen electronic nameplate



Figure 2.4 7" dual-screen electronic nameplate

### ■ Overview

This high-end electronic nameplate adopts a 7" TFT dual-screen display and true color design. It supports a screen resolution of 1024x600 and POE power supply. It has an integrally formed aluminum base and a plexiglass transparent frame, delivering smooth lines and a compact structure. The attractive and modern appearance design sets a new trend for the nameplate industry.

The double-screen electronic nameplate boasts a high refresh rate, which eliminates display flickering when you take a picture with any camera. By connecting to the management controller, you can set the name and background of each electronic nameplate individually for different nameplate IDs, or set them in batches.

### ■ Features

1. 7" TFT dual-screen display, 10-bit true color enabling vivid design in red, green, and blue, display of participants' names, positions, and other information.
2. An integrally formed aluminum alloy base, and a plexiglass transparent frame, bringing a stylish appearance.
3. Supports a resolution of 1024x600.
4. High refresh rate, preventing screen flicking during photographing.
5. Supports both POE and independent power supply (DC 12V).
6. Supports local and wireless control, and batch entry of information.

## 2.6 Panel dimensions

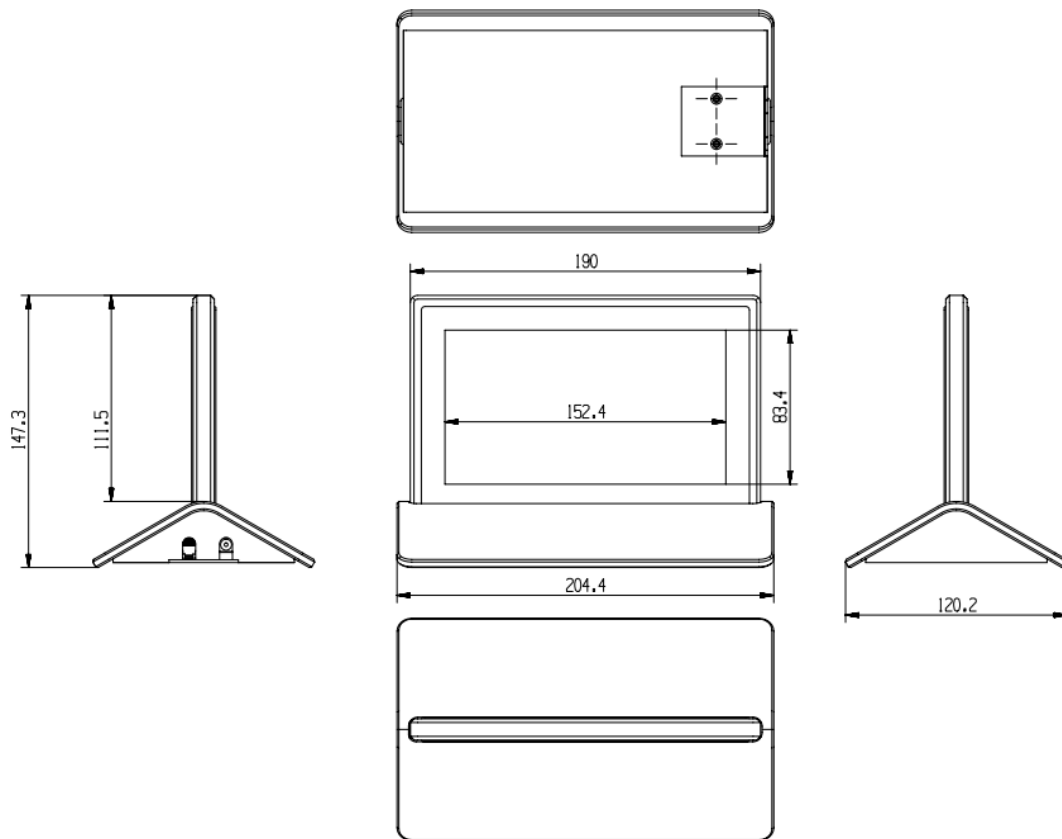

Figure 2.5 Dimensional drawing of the 7" electronic nameplate panel

1. 7" LCD, with a resolution of 1024x600
2. Reset button for clearing the nameplate binding information
3. 100M Ethernet interface, standard PoE power supply
4. DC 12V power supply

## 2.7 Specifications of the 7-inch dual-screen electronic nameplate

Item	Specifications
Display	16:9 TFT, 7", 2 pieces
Resolution	1024x600
Display color	True color 10-bit, vivid display in red, green, and blue
Brightness	450 nl
Dominant frequency	1.3 G
Memory	1 GB
Storage	16 GB
PoE power supply	Rj45 interface
Power supply interface	DC 12V
Weight	1050 g
Dimension	225(L) × 100(W) × 150(H)

## 2.8 10" dual-screen electronic nameplate



Figure 2.6 10" dual-screen electronic nameplate

### ■ Overview

The electronic nameplate adopts a 10" TFT dual-screen display. The primary screen is a touch screen. The secondary screen is not a touch screen, and it displays only the names of participants.

This nameplate adopts a true color design, enabling vivid display in red, yellow, and green. It supports a screen resolution of 1600x600 and a POE power supply. It has an integrally formed aluminum base and a plexiglass transparent frame, delivering smooth lines and a compact structure. The attractive and modern appearance design sets a new trend for the nameplate industry.

### ■ Features

1. Supports both POE and independent power supply (DC 12V).
2. Supports local and wireless control, and batch entry of information.  
Touch screen, supporting sign-in, call service, seat management, and other functions.
3. An integrally formed aluminum alloy base, and a plexiglass transparent frame, bringing a stylish appearance.
4. 10" TFT dual-screen display, 10-bit true color enabling vivid design in red, green, and blue, display of participants' names, positions, and other information.

## 2.9 Panel dimensions

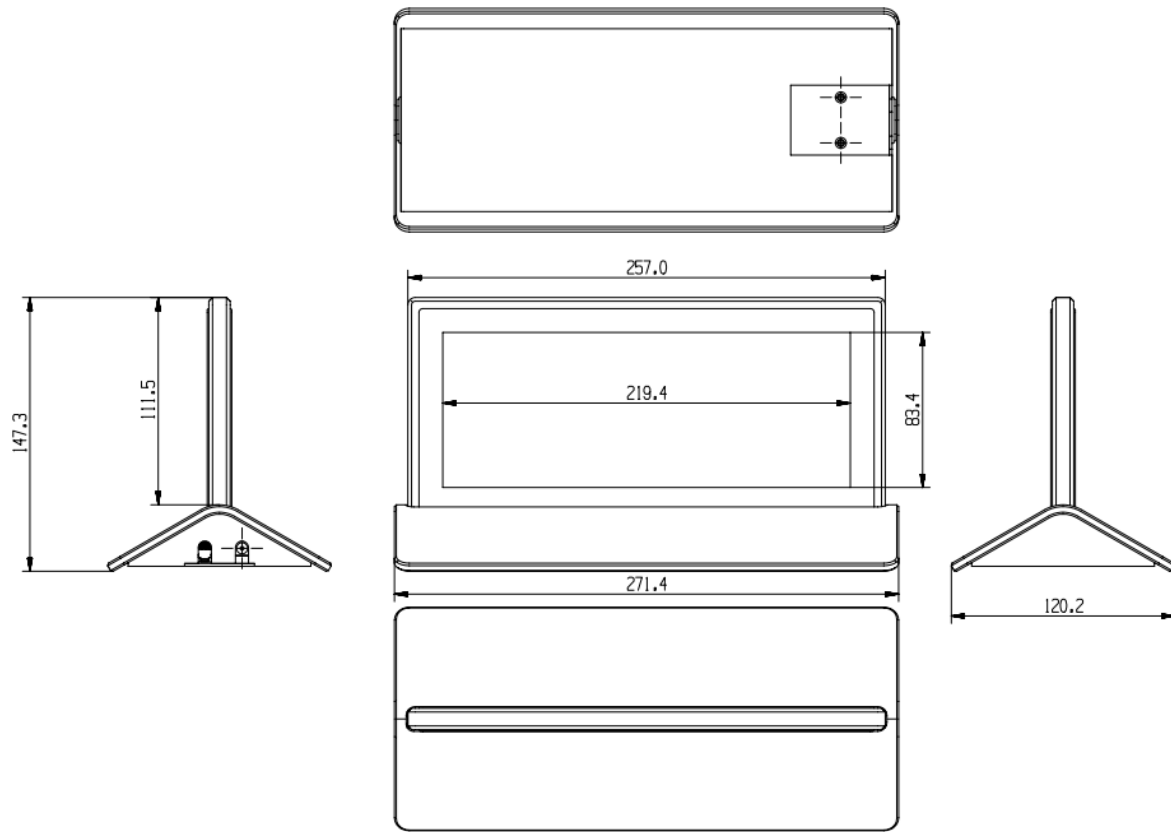

Figure 2.7 Dimensional drawing of the 10" electronic nameplate panel

1. 10" LCD, touch screen with a resolution of 1600x600
2. 10" LCD, with a resolution of 1600x600
3. Reset button for clearing the nameplate binding information
4. 100M/1000M Ethernet interface, supporting standard PoE power supply
5. DC 12V power supply

## 2.10 Specifications of the 10-inch dual-screen electronic nameplate

Item	Specifications
Display	16:9 TFT, 10", 2 pieces
Resolution	1600x600
Display color	True color 10-bit, vivid display in red, green, and blue
Brightness	450 nl
Dominant frequency	2 G
Memory	2 G
Touch screen	10" capacitive touch screen
Storage	16 GB
PoE power supply	Rj45 interface
Power supply interface	DC 12V
Weight	1500 g
Dimension	271(L) × 104(W) × 146(H)

■ 10" System connection diagram

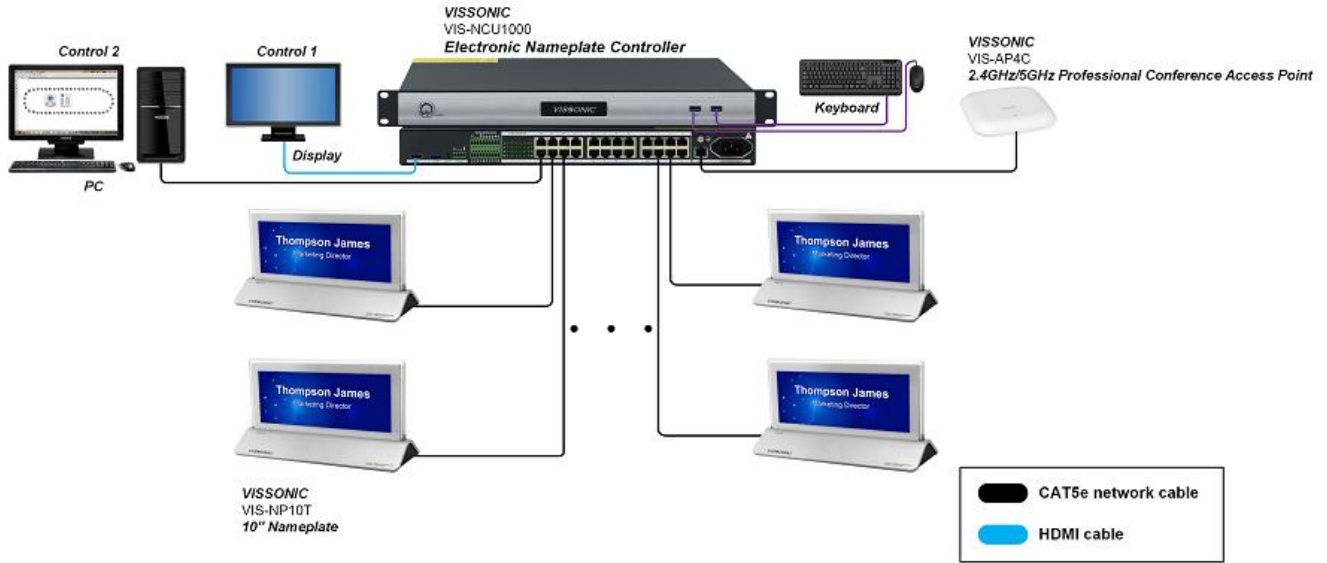

■ 7" System connection diagram

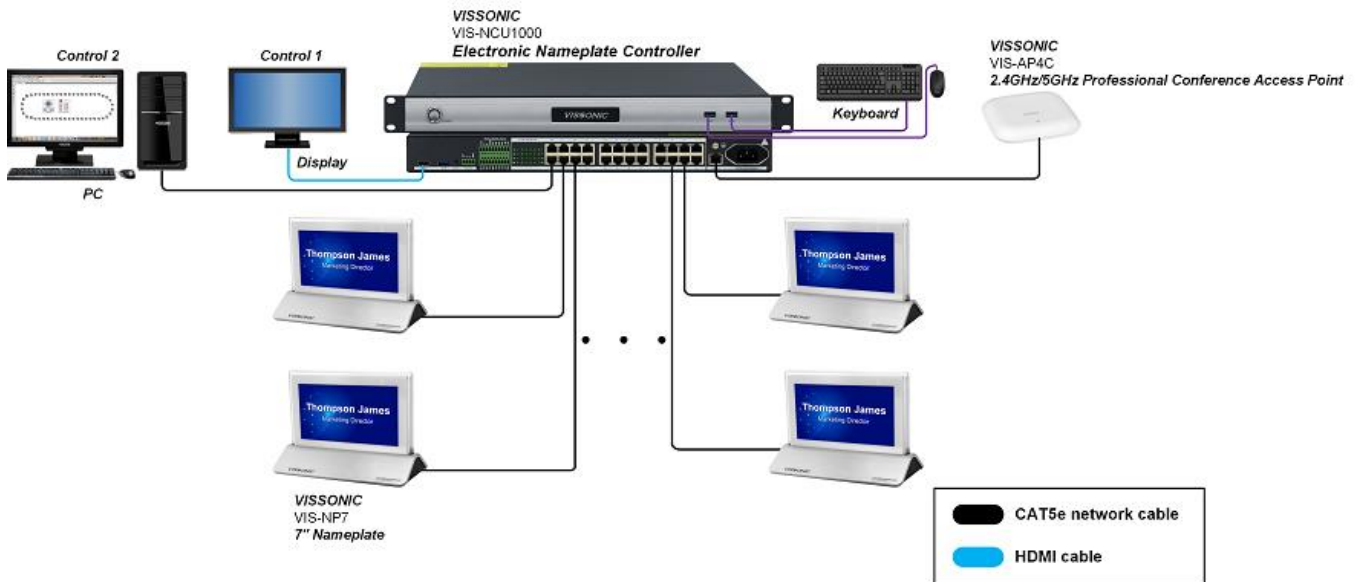

✧ You can extend the quantity and scope of use of the electronic nameplate through a POE switch.

**Attention please:** The system provides two ways to connect to the controller ,choose one of the two.

- ① Connect the host to controller 1;
- ② Connect the host to controller 2.



# Chapter Three Software description

## 3.1 Configuration

1. The default controller IP is 192.168.1.252.
2. configuration: Set the PC network, configure the relevant computer IP address, subnet mask, gateway.

**NOTE:** The computer IP address must be on the same network segment as the electronic table host IP address.

3. The default IP address of the host is 192.168.1.252.

## 3.2 Login

Connect the computer and the nameplate controller to the same route. Enter 192.168.1.252 in the browser to go to the electronic nameplate conference system.

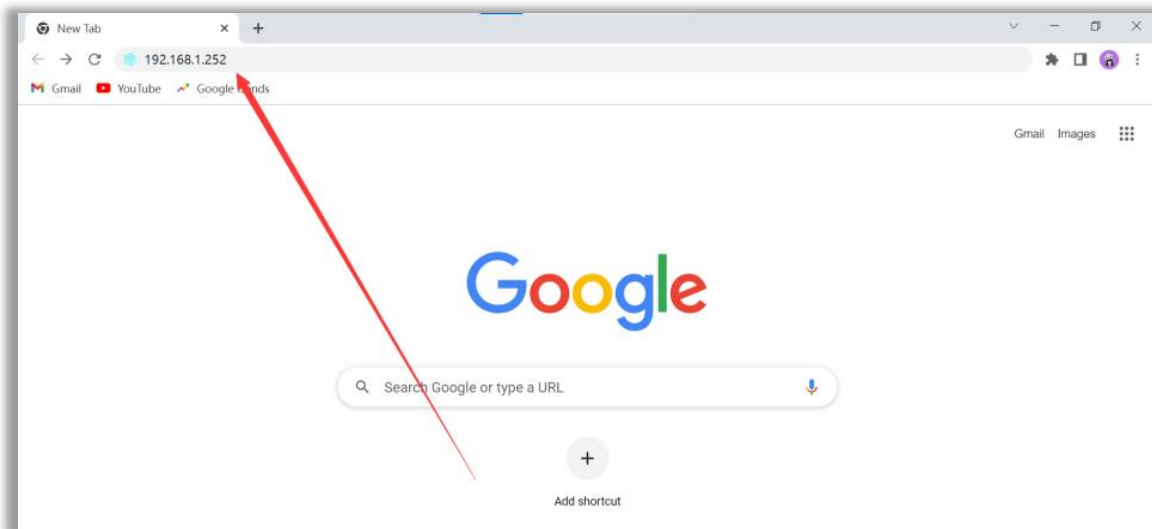

On the login page of the electronic nameplate conference system:

- (1) Enter the user name. The administrator account is **admin**.
- (2) Enter the user password. The administrator account password is **admin**.
- (3) You can select the system language.

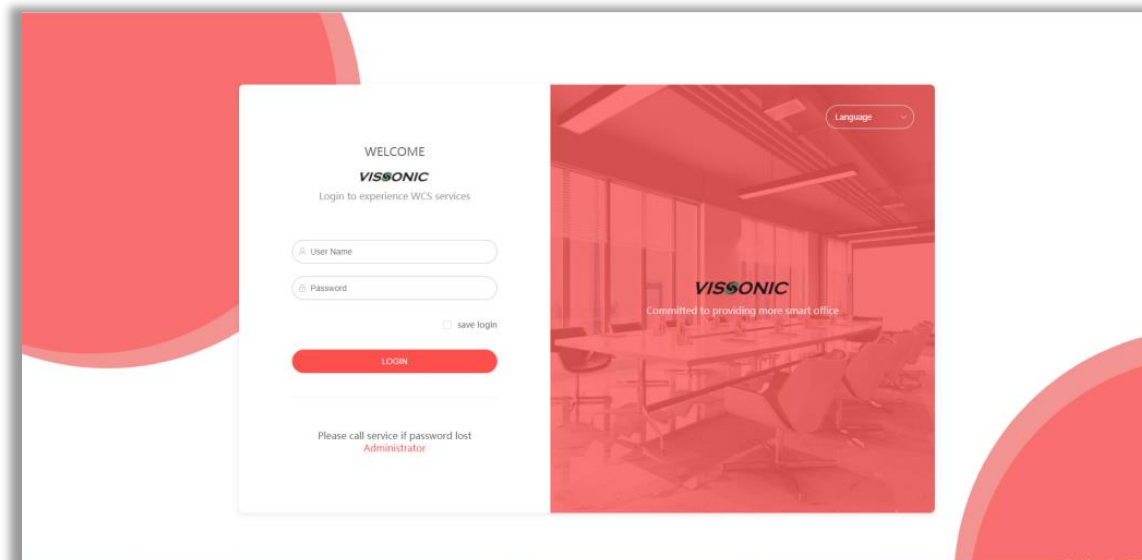

### 3.3 Login to the home page of the electronic nameplate conference system

On the home page of the electronic nameplate conference system:

- (1) You can view the indexes.
- (2) You can view the daily, weekly, and monthly data.
- (3) You can view the booked conferences and conference rooms

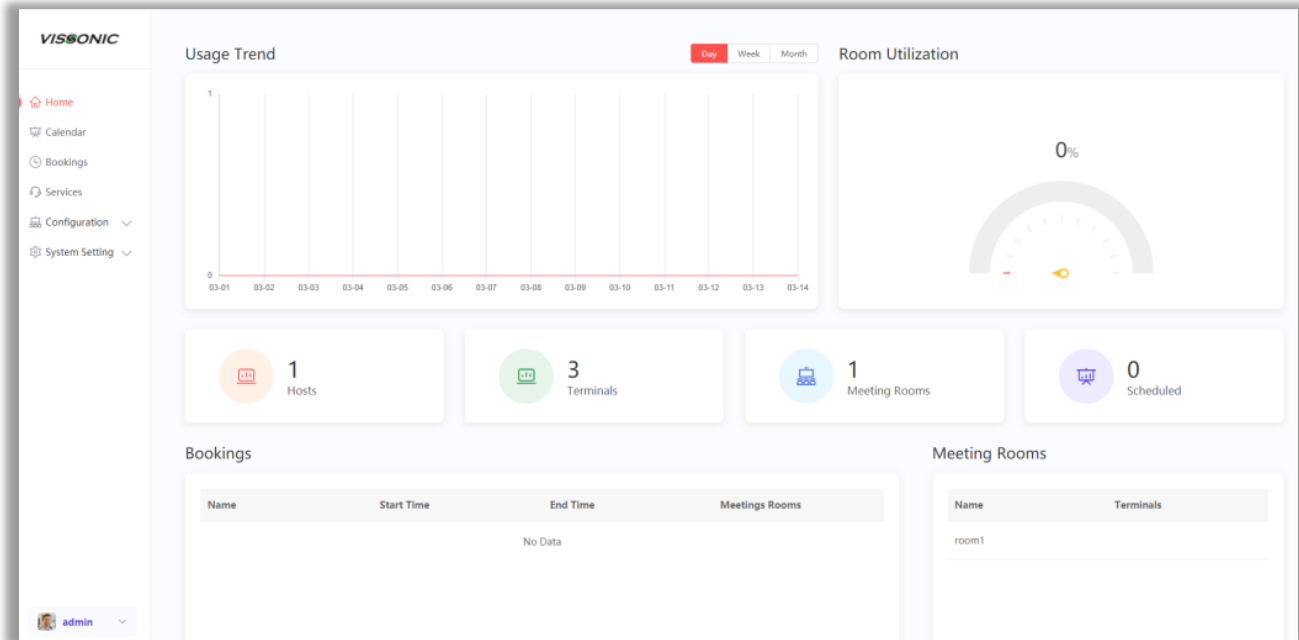

## 3.4 Controller configuration

- (1) Click "System Setting".
- (2) Select "Server Config".
- (3) On the "Basic Settings" tab, you can change the **IP address**, **gateway**, and **terminal language**. Through time settings, you can synchronize the time of the controller.

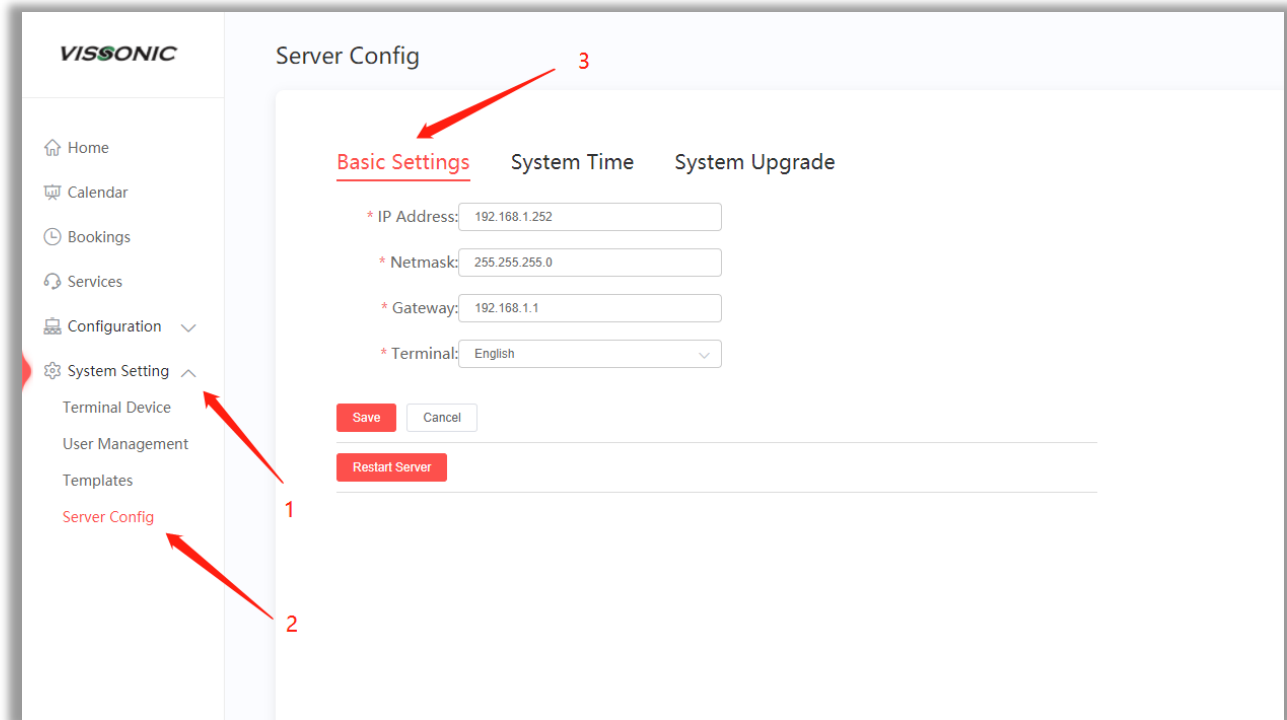

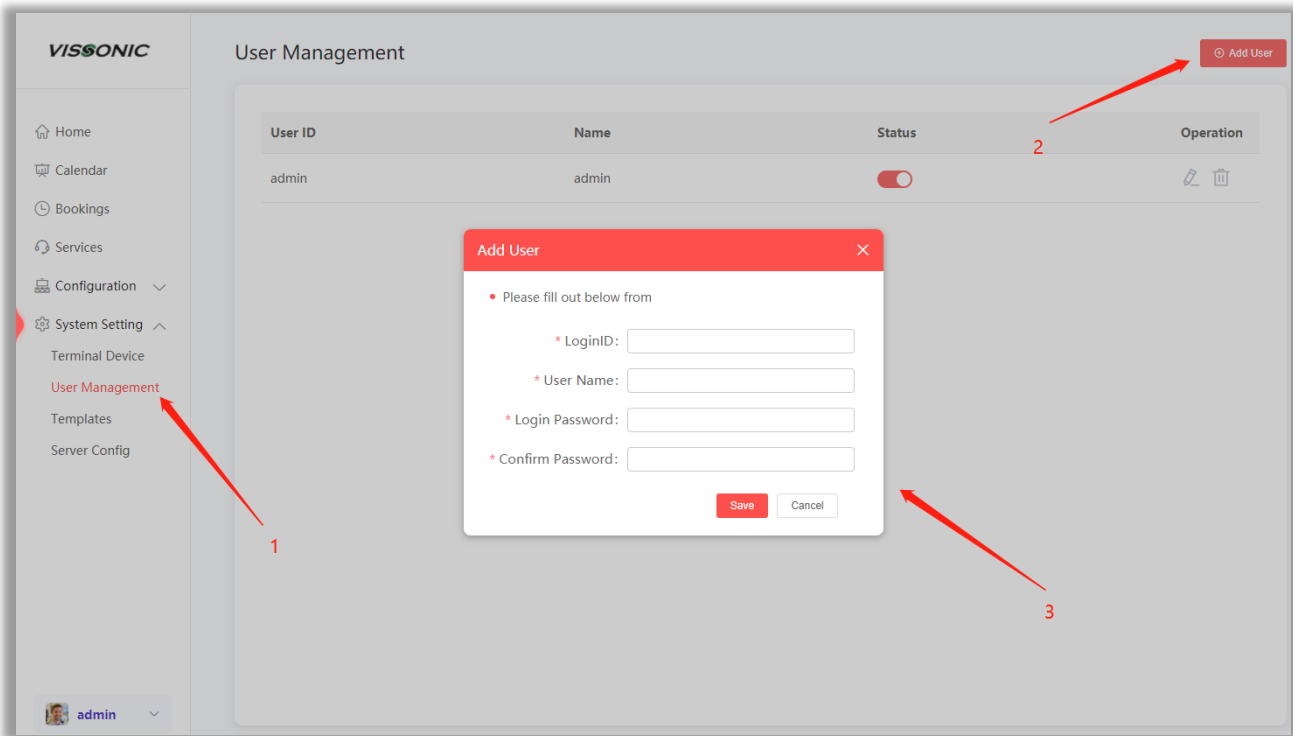

### 3.5 User management

- (1) Select "User Management" in "System Setting", and click "Add User".
- (2) After you fill in and save the user information, a user will be added.



### 3.6 Nameplate binding

- (1) Click "System Setting".
- (2) Select "Terminal Device".
- (3) Click "Auto Discovery".
- (4) The nameplates scanned by auto-discovery will be listed.
- (5) You can click the nameplate flash icon  to locate a nameplate.
- (6) You can click the bind icon  to bind a nameplate. After you click "OK", the nameplate is bound successfully.

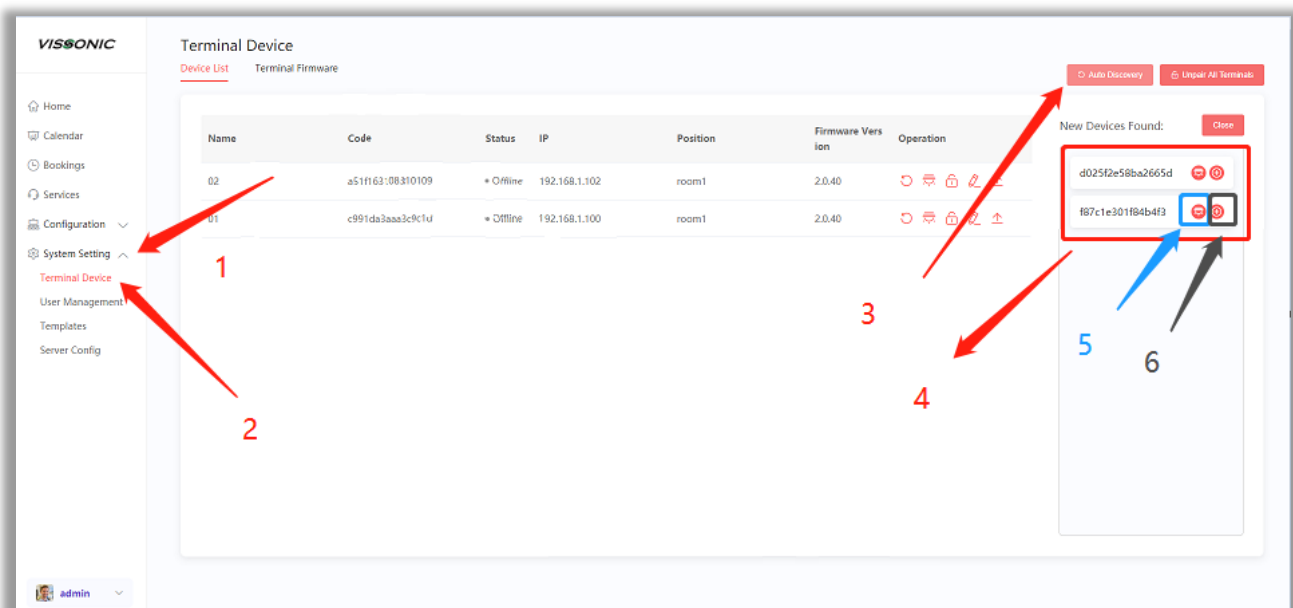

### 3.7 Terminal device

- (1) The operations from left to right in the box are restart, flash, unbind, edit, and upgrade, all of which correspond to a single nameplate. You can click the edit icon to change the nameplate name or click the unbind icon to unbind the nameplate.
- (2) You can click "Unpair All Terminals" to unbind all the nameplates in batches.

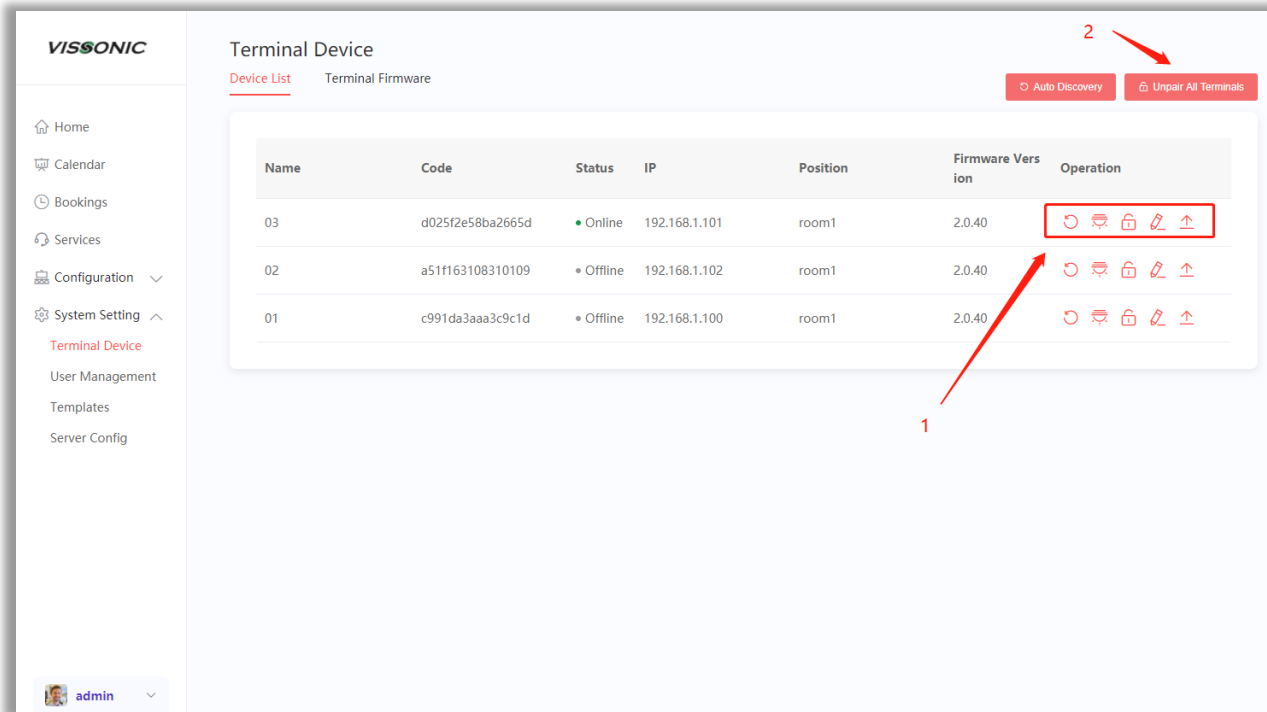

### 3.8 Nameplate template

- (1) Click "Templates".
- (2) Click "Add Templates".

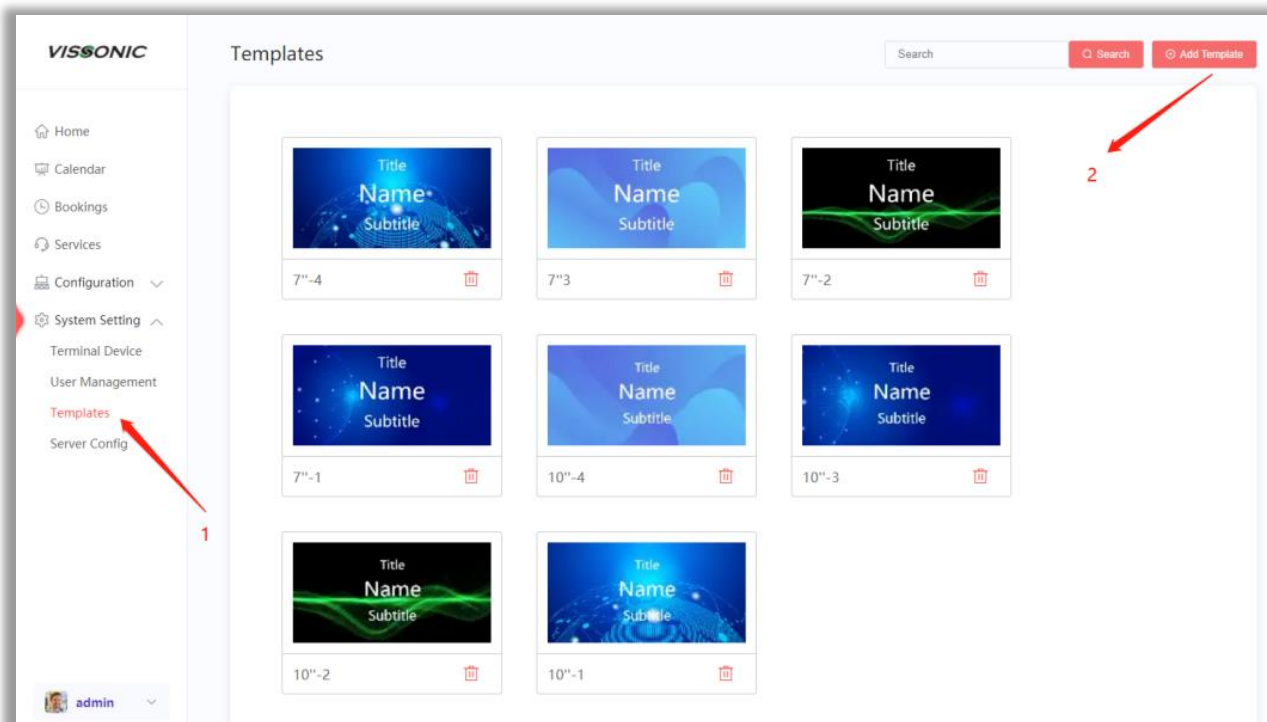

### 3.9 Setting the nameplate template

- (1) Edit the layout name.
- (2) The template is available in three sizes, and each size is marked with the template resolution
- (3) The supported terminal model is displayed for the selected size.
- (4) Click "Upload" to upload a custom template image.

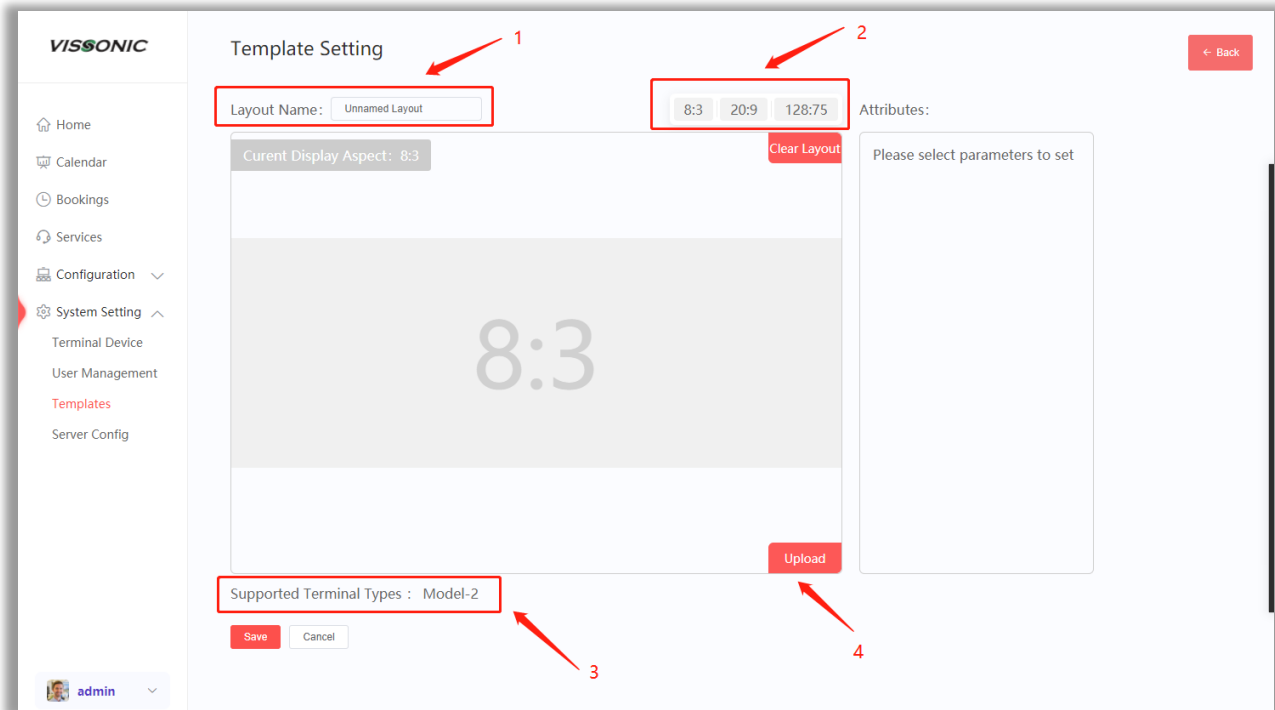

- (5) After uploading the image, you can edit the title, name, subtitle, and ID, and drag them to the desired position.
- (6) You can click the title, subtitle, name, and ID to change their attributes in the attribute area on the right.
- (7) After editing the attributes, click "Save". The template will be added successfully.

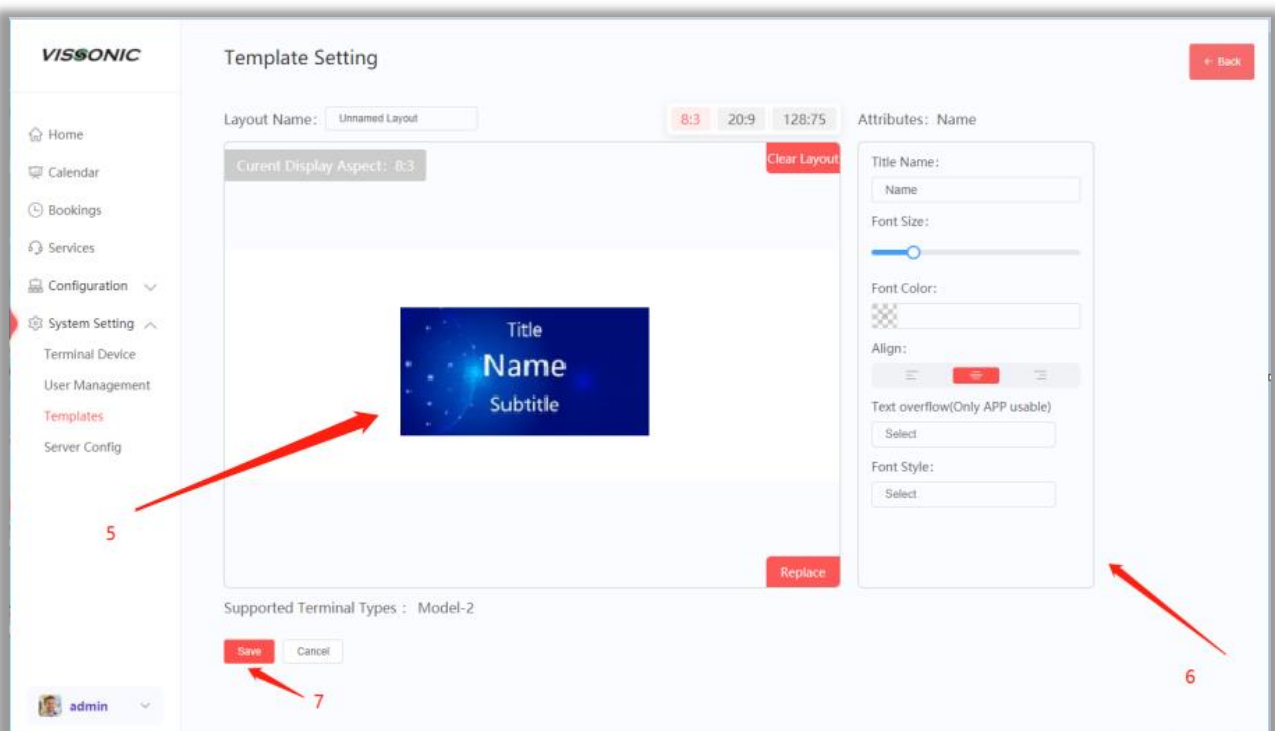

### 3.10 Adding a conference room

- (1) Click "Configuration".
- (2) Click "Regions".
- (3) Click "Add".
- (4) Add the address, for which you can edit the name, type, and address code. The type options include the region, building, floor, and room. The address code is user-defined.

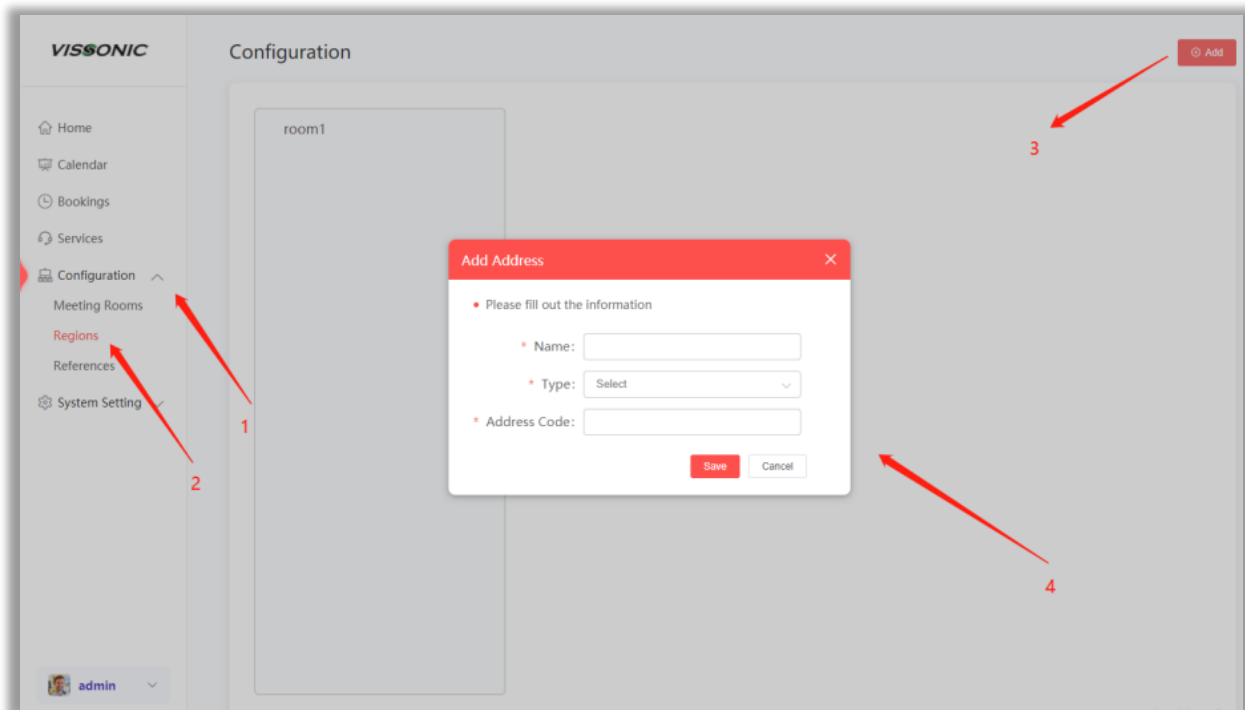

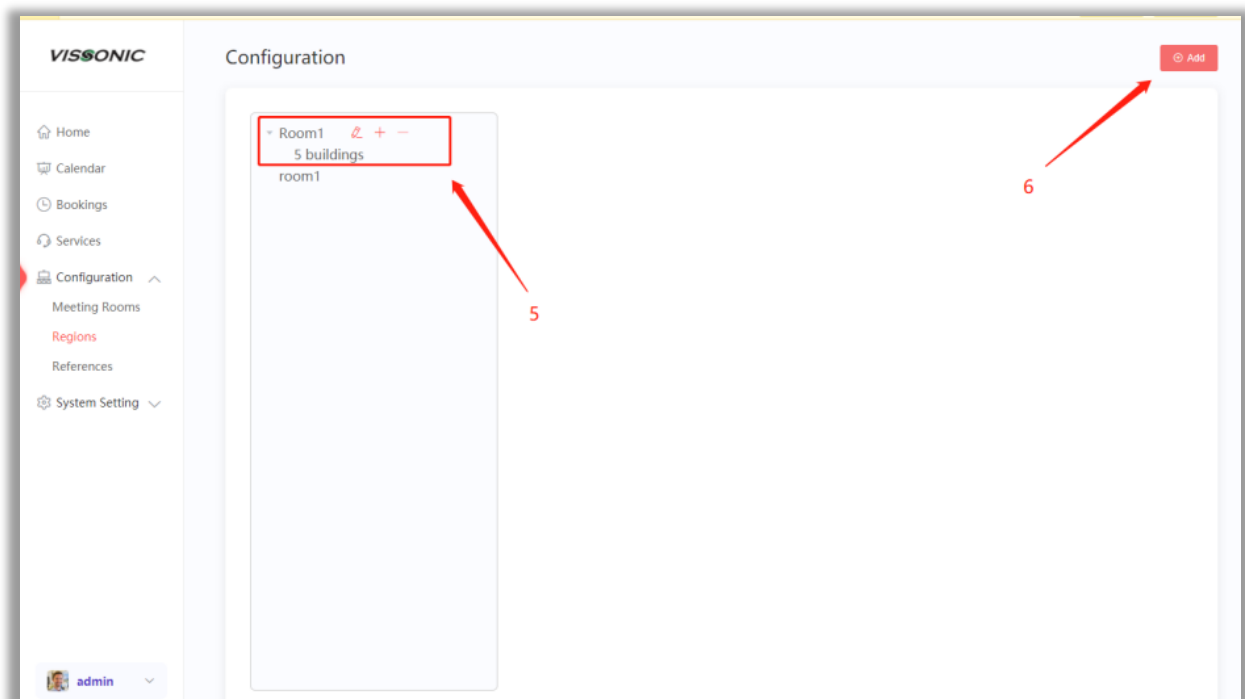

- (5) After adding a region, building, or floor, you can perform the edit, add, or delete operation. The add operation is to add a floor or room to a building.
- (6) Rooms can be added individually.

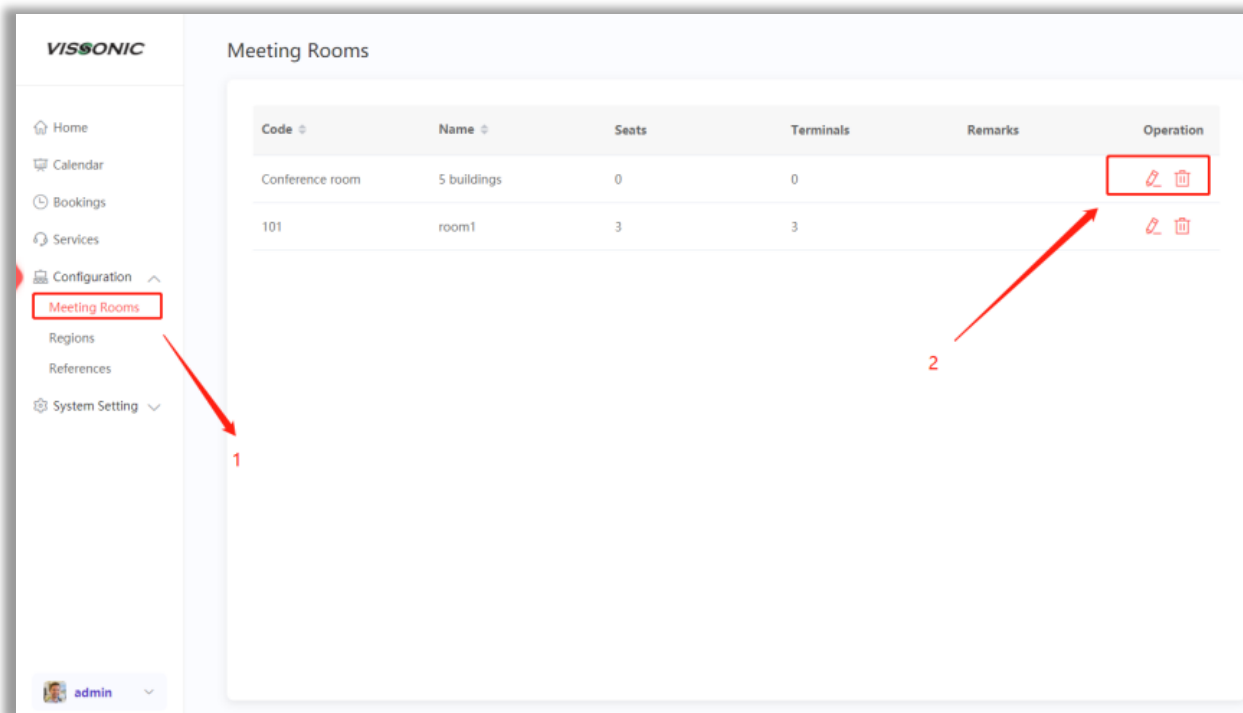

### 3.11 Editing a conference room

- (1) After adding a conference room, click "Meeting Rooms" to view the added conference rooms here.
- (2) The edit and delete icons are available in the "Operation" column. Click the edit icon to enter the edit page, or click the delete icon to delete a conference room.



- (3) After entering the edit page, select "Rooms Layout".
- (4) You need to click the unlock icon  before editing the layout.
- (5) Drag the seat to the layout box.
- (6) You can select multiple seats to align them with one click, or manually set the layout.
- (7) Click the seat to configure the code. The code is user-defined.
- (8) Drag the terminal to the seat.
- (9) Click "Save". The conference room layout will be successfully edited.

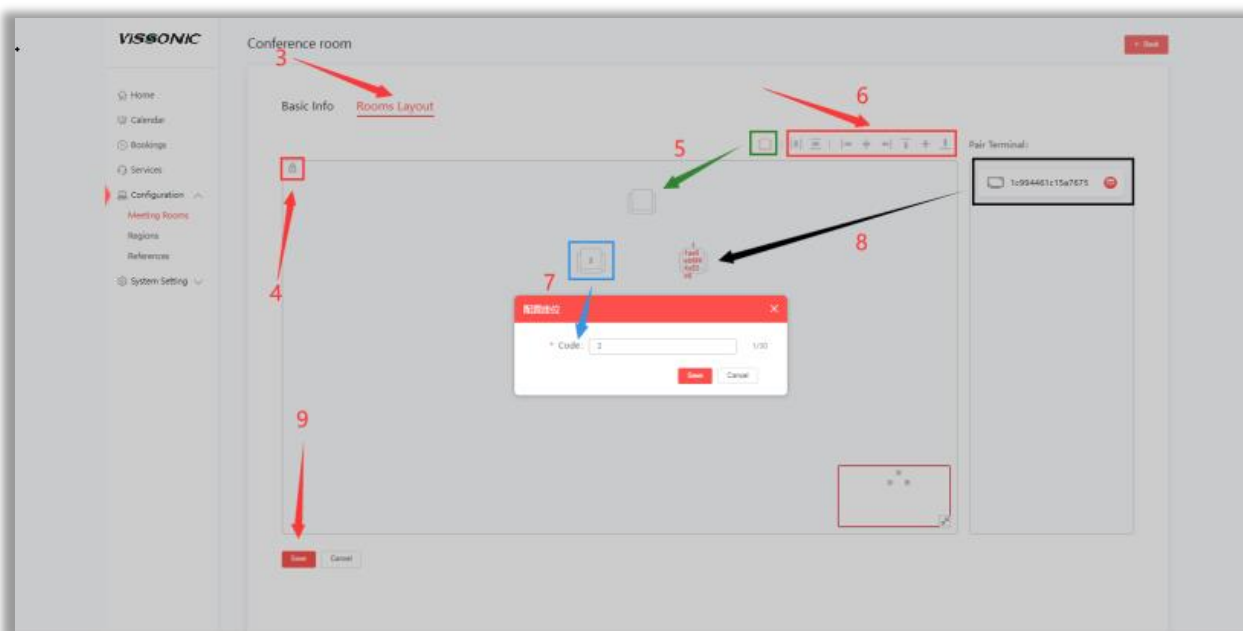





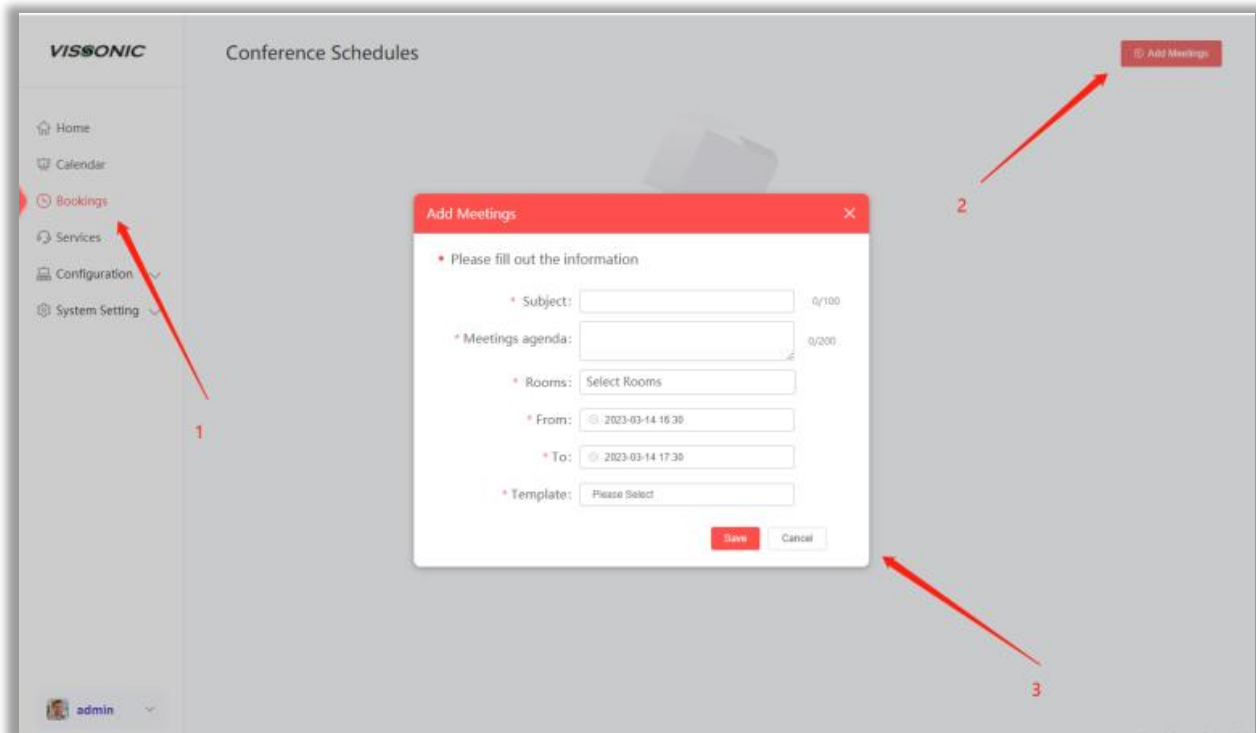

## 3.12 Conference reservation

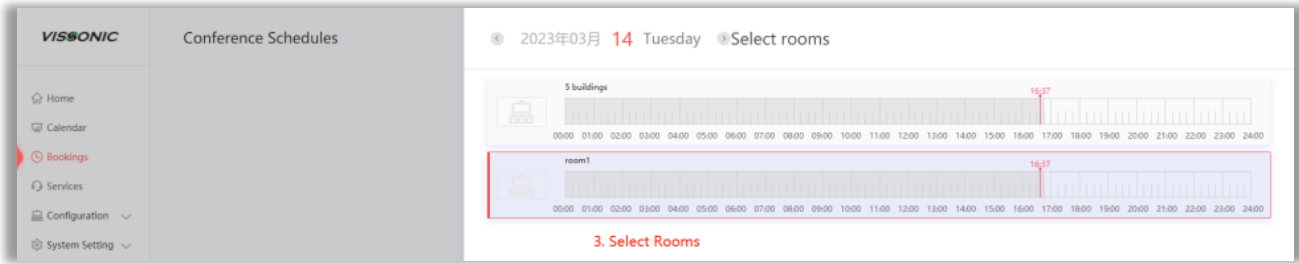
- (1) Click "Bookings".
- (2) Click "Add Meetings".
- (3) Fill in the conference information. You can select a conference room that has been added.





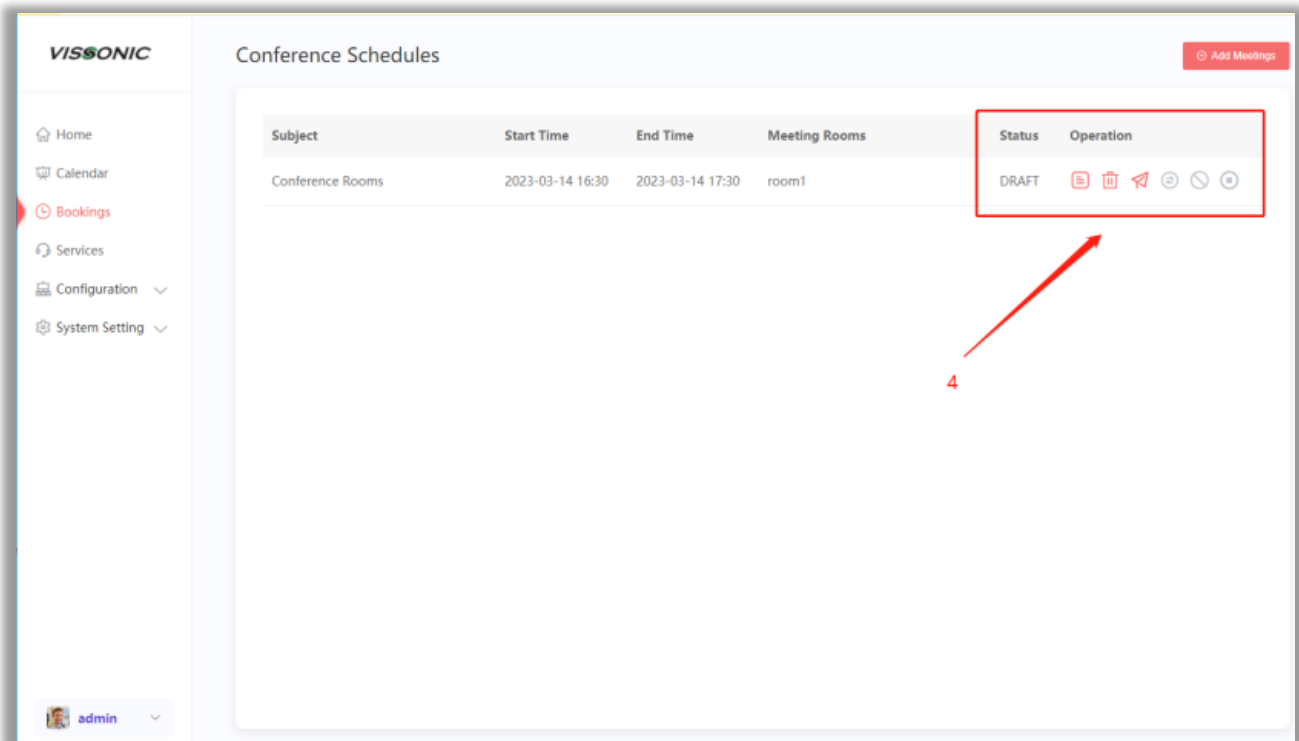

(4) After adding a conference, you can edit , delete , or publish  the conference.



### 3.13 Conference preparation

- (1) This toolbar displays the icons of conference publishing, conference editing, conference deleting, and going back to the previous level from left to right.
- (2) You can click the  icon to import a roster and click the  icon to add a single participant. After the addition, drag it to the seat.
- (3) You can also click the seat to add a participant.
- (4) Edit the participant information. You can select a nameplate template. If no template is selected, the default one is the nameplate template you selected in the process of conference information editing.
- (5) The smart allocation and dry run functions are available.

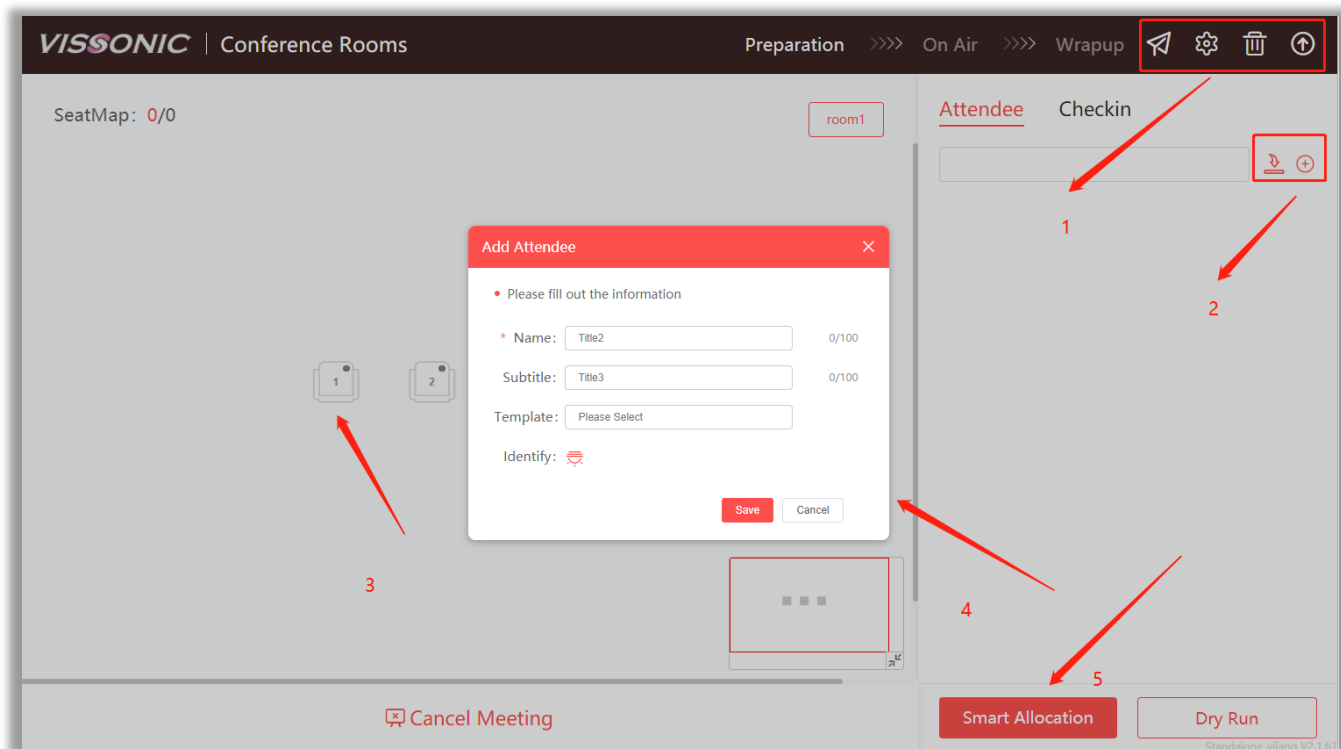

### 3.14 Conference sign-in

- (1) The sign-in function is available only after a conference has been started.
- (2) Fill in the relevant information. Then, click "Save". The countdown is calculated **in seconds**.
- (3) Click "Start Checkin" at the bottom right corner to complete the check-in.

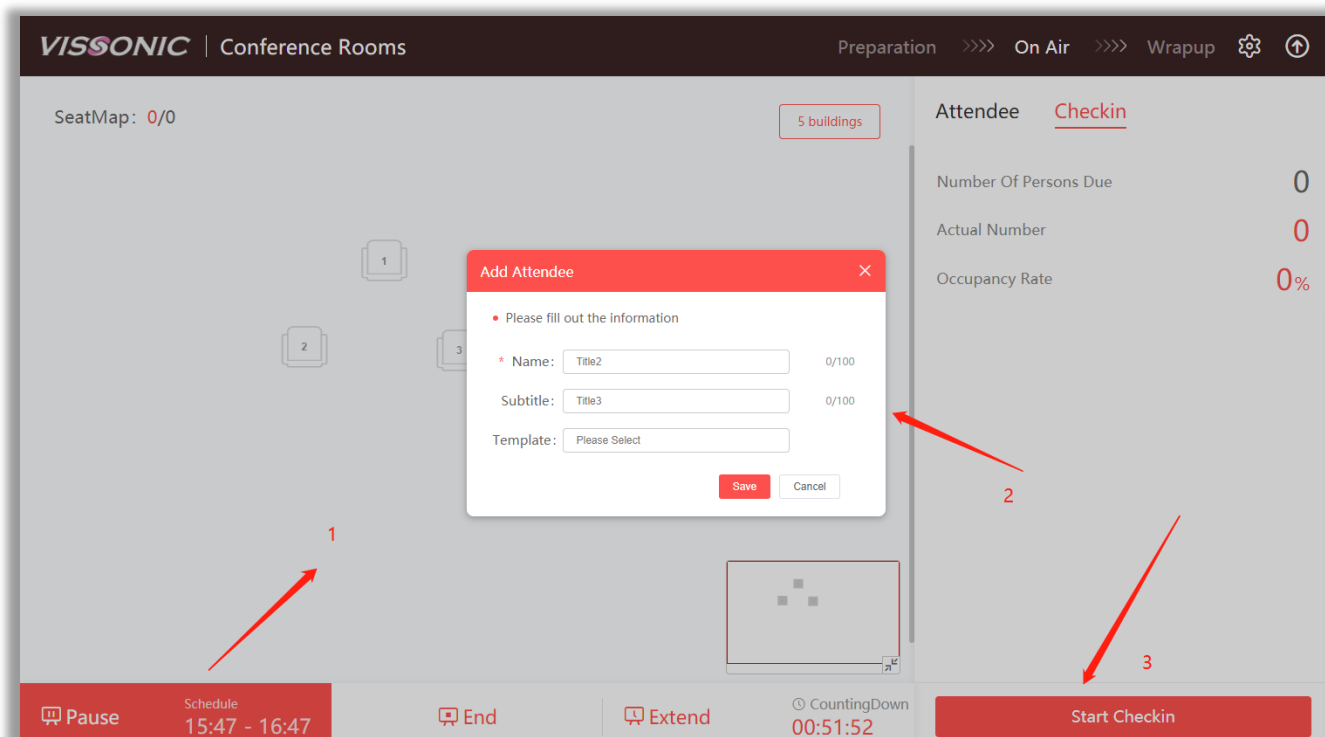

### 3.15 Conference process

- (1) After publishing a conference, you can manually start the conference. Otherwise, the conference will be automatically started at the scheduled time. During a conference, you can suspend, end, or delay the conference, change seat management, and perform sign-in.
- (2) The sign-in function can be repeatedly enabled. The signed-in participants will not be displayed.

The screenshot displays the VISSONIC Conference Rooms interface. At the top, the status is 'Preparation >>> On Air >>> Wrapup'. The main area shows a 'SeatMap: 0/0' with a 'room1' label. A red arrow labeled '1' points to the 'Start Checkin' button in the bottom control bar. The right-hand panel shows 'Attendee Checkin' with the following statistics:

Metric	Value
Number Of Persons Due	2
Actual Number	0
Occupancy Rate	0%

The bottom control bar contains the following elements from left to right: 'Pause' button, 'Schedule 15:25 - 16:25', 'End' button, 'Extend' button, 'CountingDown 00:56:26', and 'Start Checkin' button. A red arrow labeled '2' points to the 'Start Checkin' button.

## 3.16 Suspend the conference

(1) If you want to rest during the meeting, you can choose to suspend the meeting. Click the button  in the lower left corner, set the name of the meeting, and click OK to suspend the meeting.

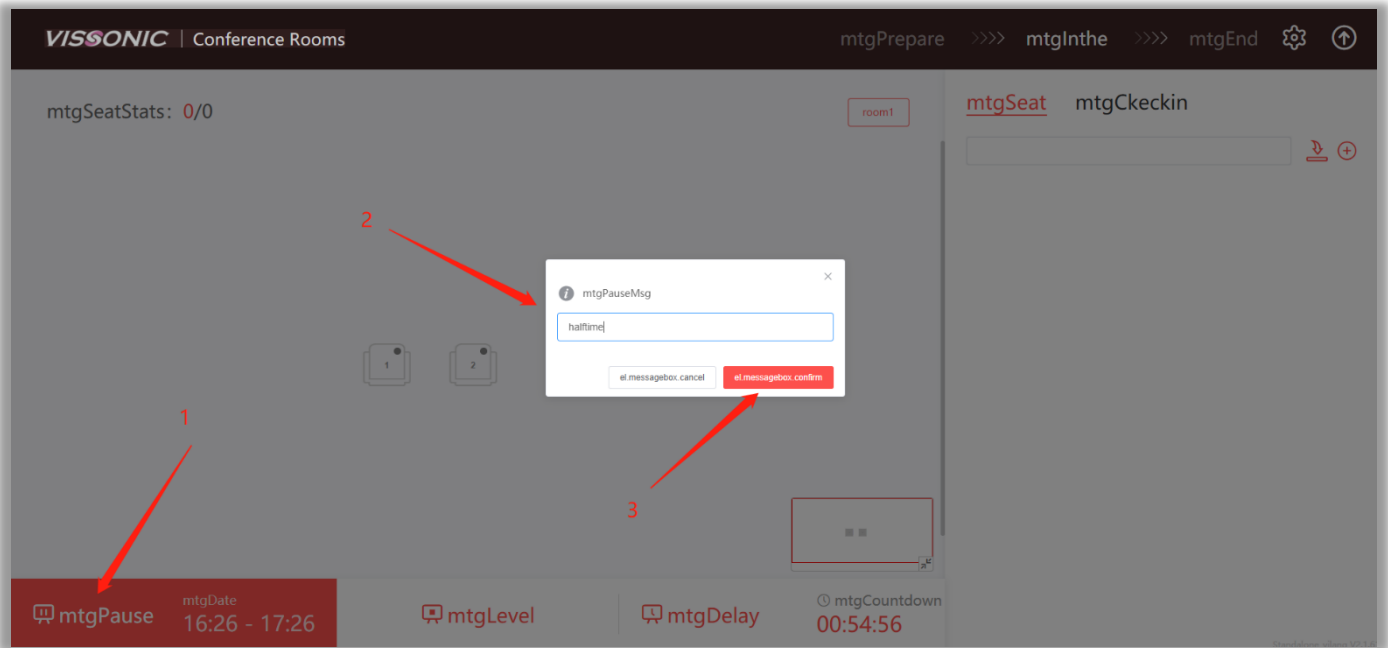

### 3.17 Archiving a conference

(1) After the conference, click "Archive" to download and archive the conference summary.

