



## OWNER'S MANUAL

# LG Digital Signage (MONITOR SIGNAGE)

---

Please read the user manual before using this product to ensure safe and convenient use.

43UH7J

49UH7J

55UH7J

65UH7J

43UH5J

49UH5J

55UH5J

65UH5J

# TABLE OF CONTENTS

## **BASIC ..... 3**

- Checking the Accessories ..... 3
- Checking the Optional Accessories..... 4
- Learning the Buttons..... 5

## **GETTING READY ..... 6**

- Connecting the IR Sensors ..... 6
- Mounting and Removing the  
LG Logo Bracket..... 7
- Kensington Lock Device ..... 8

## **CHECKING BEFORE INSTALLATION ..... 9**

- Installation Orientation ..... 9
- Installation Location..... 10
- Wall Mount Holder ..... 11

## **PRECAUTIONS FOR USE..... 12**

- Dust..... 12
- Afterimage ..... 12

## **PRODUCT SPECIFICATIONS..... 14**

## **LICENCE..... 20**

**WARNING** - This equipment is compliant with Class A of CISPR 32. In a residential environment this equipment may cause radio interference.

## BASIC

### ! NOTE

- The accessories provided with your product may vary depending on the model or region.
- Product specifications or contents in this manual may be changed without prior notice due to upgrade of product functions.
- SuperSign Software & Manual
  - Visit <https://partner.lge.com> to download the latest SuperSign software and manual.

## Checking the Accessories

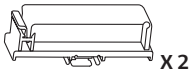
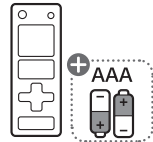
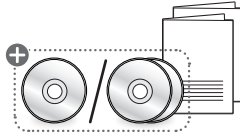
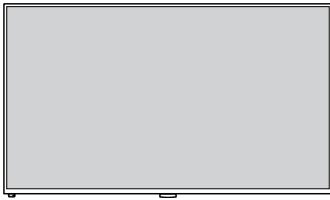

X 2

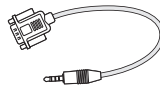
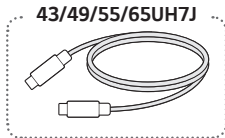

+ Depending on country

## Checking the Optional Accessories

In order to improve product performance, optional accessories are subject to change without prior notice. The illustrations in this manual may differ from the actual product and its accessories. Refer to the product manual for the components of the optional accessories.

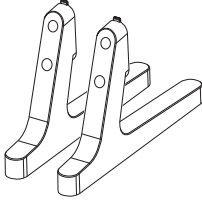

**ST-653T**

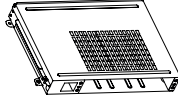

**KT-OPSF**

### **!** NOTE

- Before you attach the OPS (Open Pluggable Specification) PC, connect the cable to the port.

## Learning the Buttons

The illustrations may differ depending on the model.

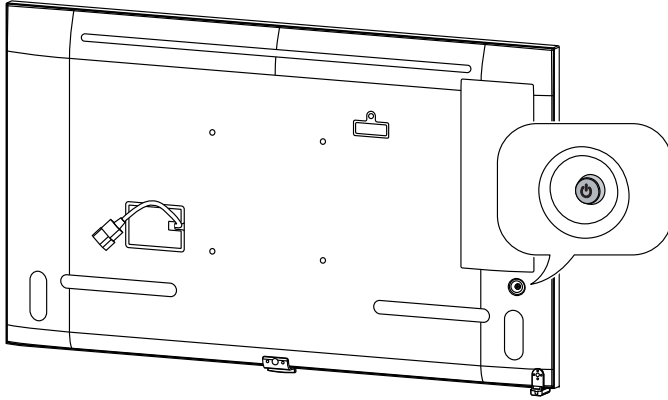

Power On (Press)  
Quick Menu (Press <sup>1</sup>)  
Menu Selection (Press <sup>2</sup>)  
Power Off <sup>3</sup> (Press and Hold)



Volume Control  
Menu Control <sup>2</sup>



Menu Control <sup>2</sup>

- 1 When the monitor is turned on, press the  button one time.
- 2 You can use the function when you control menu.
- 3 All running apps will close.

### Quick Menu



Turns the power off.



Accesses the main menu.



Changes the input source.



Close the quick menu.

# GETTING READY

## Connecting the IR Sensors

Connecting the cable to the product allows it to receive signals from the remote control.

Rotate the IR sensor according to horizontal or vertical use.

- The illustrations may differ depending on the model.

### Default Mount - Horizontal Use

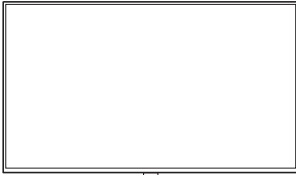

(Front)

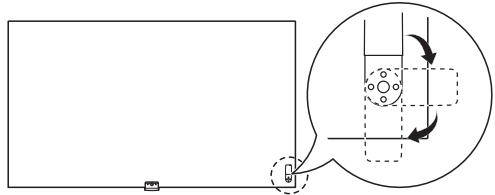

(Back)

### Vertical Use

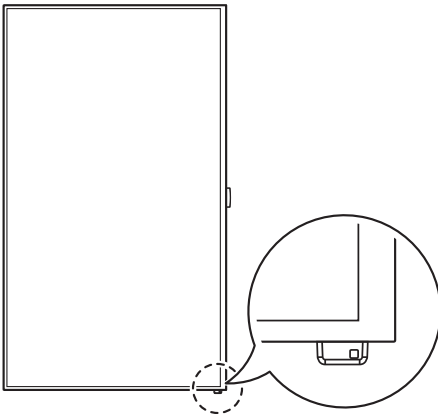

(Front)

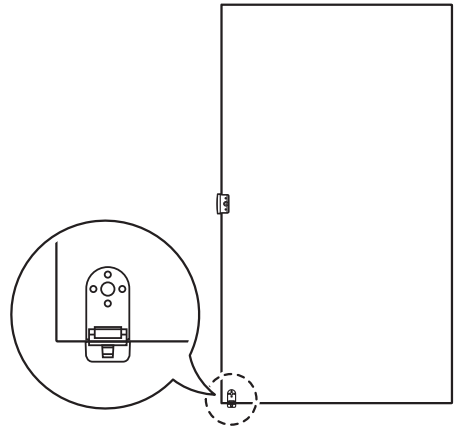

(Back)

## Mounting and Removing the LG Logo Bracket

- Applies only to some models.
- The illustrations may differ depending on the model.

### Removing the LG Logo Bracket

Place a clean cloth on the floor, and remove one screw from the LG logo bracket on the lower back of the monitor with a screwdriver.

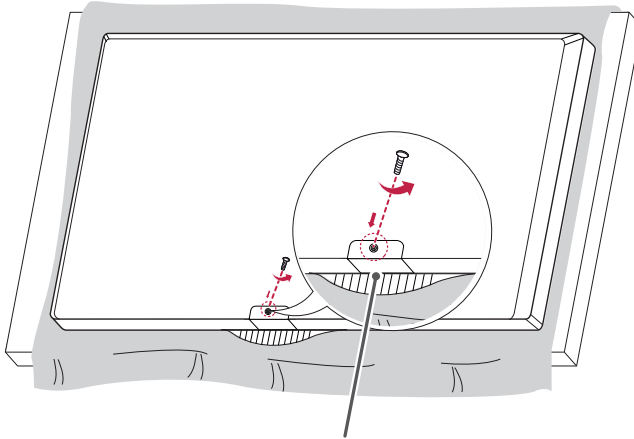

LG Logo Bracket

### Mounting the LG Logo Bracket on the Right

Screw the LG logo bracket into the hole on the right.

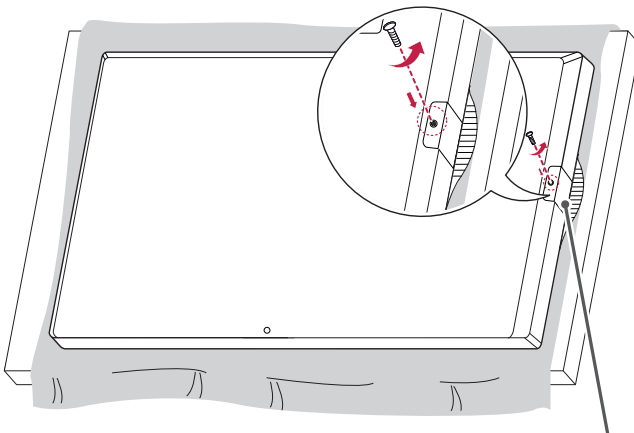

LG Logo Bracket

## Kensington Lock Device

(This feature applies only to some models.)

The Kensington lock device connector is located on the back of the monitor. For more information on installation and use, refer to the user manual provided with the locking device.

Connect the Kensington security system cable between the monitor and a table.

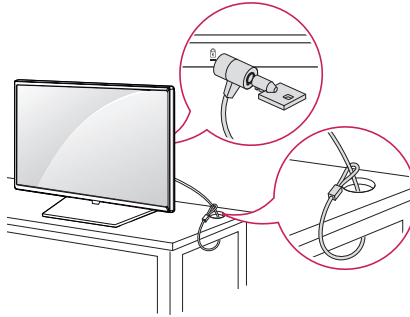

### ! NOTE

- The Kensington lock device is an optional specification.
- This is a general illustration of installation and may look different from the product held by the customer.



# CHECKING BEFORE INSTALLATION

We are not responsible for product damage caused by failure to follow the guide.

## Installation Orientation

### Using Vertically

When installing vertically, rotate the monitor 90 degrees anti-clockwise while facing the front of the screen.



### Tilt Angle

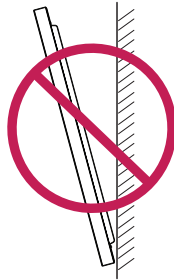

### Ceiling, Floor Orientation

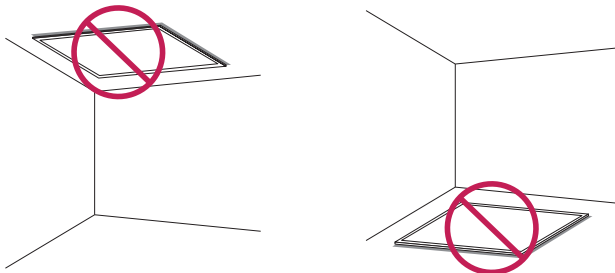

## Installation Location

We are not responsible for product damage caused by failure to follow the guide.

### Indoor

#### Installing on a Wall

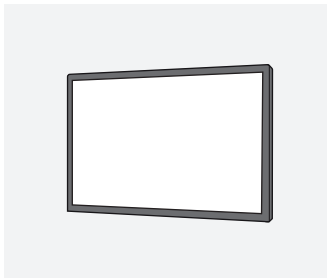

A : 40 mm or more

- The warranty will not cover any damage caused by using the product in direct sunlight on the front panel.

#### Installing on a Recessed Wall

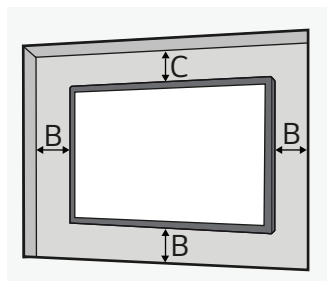

A : 40 mm or more

B : 50 mm or more

C : 70 mm or more

- The warranty will not cover any damage caused by using the product in direct sunlight on the front panel.

### Outdoor

#### Outdoor Enclosed



## Wall Mount Holder

To install the monitor on a wall, attach a wall mount holder (optional) to the back of the monitor. Take caution, and ensure that the wall mount holder (optional) is securely fixed to the monitor and to the wall. The VESA dimensions of the wall mount by model are as follows.

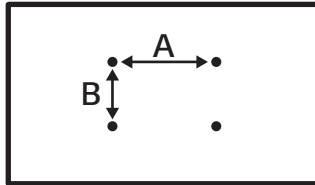

| Model            | VESA Dimensions (A x B) (mm) | Standard Dimensions | Length (Maximum) (mm) | Quantity |
|------------------|------------------------------|---------------------|-----------------------|----------|
| 43UH5J<br>43UH7J | 200 x 200                    | M6                  | 15.6                  | 4        |
| 49UH5J<br>49UH7J | 300 x 300                    | M6                  | 15.6                  | 4        |
| 55UH5J<br>55UH7J | 300 x 300                    | M6                  | 15.6                  | 4        |
| 65UH5J<br>65UH7J | 300 x 300                    | M6                  | 15.6                  | 4        |

### CAUTION

- Disconnect the power cord first, and then move or install the monitor. Otherwise, it may result in electric shock.
- If the monitor is installed on a ceiling or inclined wall, it may fall and result in injury.
- Damage to the monitor by tightening the screws too tightly may void your warranty.
- Use screws and wall mount plates conforming to VESA standards. Breakage or personal injury due to use or misuse of inappropriate components is not covered by the warranty of this product.

### NOTE

- Using screws longer than the indicated depth may damage the inside of the product. Be sure to use the proper length.
- For more information on installation, please refer to the user manual for the wall mount.

# PRECAUTIONS FOR USE

## Dust

The warranty will not cover any damage caused by using the product in an excessively dusty environment.

## Afterimage

- After-image appears when the product is turned off.
  - Pixels may be damaged rapidly if a still image is displayed on the screen for a long period of time. Use the screen-saver function.
  - Switching from a screen with high differences in luminance (black and white or grey) to a darker screen may cause an afterimage. This is normal due to the display characteristics of this product.
- When the LCD screen is in a still pattern for extended periods of use, a slight voltage difference may occur between the electrodes that operate the liquid crystal (LC). The voltage difference between the electrodes increases over time and tends to keep the liquid crystal aligned in one direction. At this time, the previous image remains, which is called an afterimage.
- Afterimages do not occur when continuously changing images are used but take place when a certain screen is fixed for a long time. The following are operational recommendations for reducing the occurrence of afterimages when using a fixed screen. The maximum recommended time for switching the screen is 12 hours. Shorter cycles are better for preventing afterimages.
- Recommended Usage Condition

1 Change the background colour and text colour at equal intervals.

- Afterimages occur less when the colours to be changed are complementary to one another.

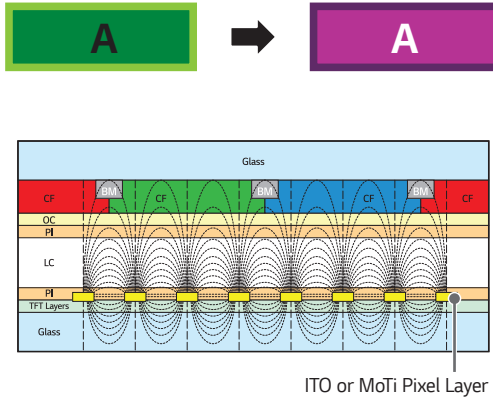

2 Switch the screen at equal time intervals.

- Take caution, and ensure that text or images from before the screen change are not left in the same location after the screen change.

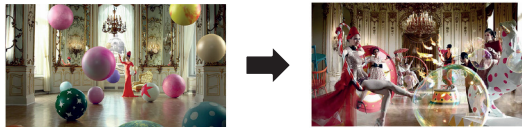

# PRODUCT SPECIFICATIONS

Without prior notice, all product information and specifications contained in this manual are subject to change to improve the performance of the product.

|                          |                        |  |
|--------------------------|------------------------|--|
| Input/Output Ports       | 43/49/55/65UH5J        | HDMI IN 1, HDMI IN 2, HDMI IN 3, DP IN, HDMI OUT, DVI-D IN, RS-232C IN/OUT, LAN, IR & LIGHT SENSOR, USB 2.0 IN, AUDIO IN/OUT, OPS              |
|                          | 43/49/55/65UH7J        | HDMI IN 1, HDMI IN 2, DP IN/OUT, DVI-D IN, RS-232C IN/OUT, USB Type-C, LAN, IR & LIGHT SENSOR, USB 2.0 IN, AUDIO IN/OUT, OPS                   |
| Resolution               | Recommended Resolution | HDMI1,2/ DisplayPort: 3840 x 2160 @ 60 Hz<br>USB Type-C: 3840 x 2160 @ 60 Hz (43/49/55/65UH7J)<br>HDMI3: 3840 x 2160 @ 30 Hz (43/49/55/65UH5J) |
|                          | Max Resolution         | OPS: 3840 x 2160 @ 30 Hz<br>DVI-D: 1920 x 1080 @ 60 Hz<br>- This may not be supported on some OS or graphics card types.                       |
| Embedded battery         | Applied                |  |
| Environmental Conditions | Operating Temperature  | 0 °C to 40 °C  |
|                          | Operating Humidity     | 10 % to 80 % (Condition for preventing condensation)   |
|                          | Storage Temperature    | -20 °C to 60°C   |
|                          | Storage Humidity       | 5 % to 85 % (Condition for preventing condensation)<br>* Product box packaging storage conditions  |
| Audio                    | Input Sensitivity      | 0.7 Vrms   |

## ! NOTE

- USB-C does not support fast charging. Gender converters for fast charging is also not supported.
- Use a certified USB-C cable (1.5 M or less). If you do not do so, the screen may not be displayed or a connection error may occur.
- USB-C port is not supported to DPM (Sleep mode).
- Video Daisy Chain can be configured through HDMI OUT, and Input Resolution can support up to 3840 x 2160 at 30 Hz, and it cannot be above 30 Hz. (UH5J only)

**43UH5J, 43UH7J**

|   |                            |                              |
|---|----------------------------|------------------------------|
| Power Voltage   | 100-240 V - 50/60 Hz 1.2 A |                              |
| Power Consumption                                       | On Mode                    | 80 W (Typ.)                  |
|   | Sleep Mode / Standby Mode  | ≤ 0.5 W                      |
| Size (Width x Height x Thickness) (mm)<br>/ Weight (kg) | Head                       | 962.5 x 568.0 x 39.9 / 11.2  |
|   | Head + Stand               | 962.5 x 613.1 x 290.0 / 11.8 |

**49UH5J, 49UH7J**

|   |                            |                               |
|---|----------------------------|-------------------------------|
| Power Voltage   | 100-240 V - 50/60 Hz 1.6 A |                               |
| Power Consumption                                       | On Mode                    | 100 W (Typ.)                  |
|   | Sleep Mode / Standby Mode  | ≤ 0.5 W                       |
| Size (Width x Height x Thickness) (mm)<br>/ Weight (kg) | Head                       | 1098.6 x 644.5 x 39.9 / 15.4  |
|   | Head + Stand               | 1098.6 x 694.3 x 290.0 / 16.0 |

**55UH5J, 55UH7J**

|   |                            |                               |
|---|----------------------------|-------------------------------|
| Power Voltage   | 100-240 V - 50/60 Hz 1.7 A |                               |
| Power Consumption                                       | On Mode                    | 110 W (Typ.)                  |
|   | Sleep Mode / Standby Mode  | ≤ 0.5 W                       |
| Size (Width x Height x Thickness) (mm)<br>/ Weight (kg) | Head                       | 1234.4 x 720.9 x 39.9 / 19.0  |
|   | Head + Stand               | 1234.4 x 770.7 x 290.0 / 19.6 |

**65UH5J, 65UH7J**

|   |                            |                               |
|---|----------------------------|-------------------------------|
| Power Voltage   | 100-240 V - 50/60 Hz 1.9 A |                               |
| Power Consumption                                       | On Mode                    | 130 W (Typ.)                  |
|   | Sleep Mode / Standby Mode  | ≤ 0.5 W                       |
| Size (Width x Height x Thickness) (mm)<br>/ Weight (kg) | Head                       | 1453.3 x 844.0 x 39.9 / 28.2  |
|   | Head + Stand               | 1453.3 x 893.1 x 290.0 / 28.8 |

**HDMI/ DVI-D/ DisplayPort/ USB-C/ OPS (PC) Support mode**

| Resolution  | Horizontal frequency (kHz) | Vertical frequency (Hz) | Remark                                |
|-------------|----------------------------|-------------------------|---------------------------------------|
| 800 x 600   | 37.879                     | 60.317                  |                                       |
| 1024 x 768  | 48.363                     | 60                      |                                       |
| 1280 x 720  | 44.772                     | 59.855                  |                                       |
| 1280 x 1024 | 63.981                     | 60.02                   |                                       |
| 1680 x 1050 | 65.29                      | 59.954                  |                                       |
| 1920 x 1080 | 67.5                       | 60                      |                                       |
| 3840 x 2160 | 67.5                       | 30                      | HDMI1/2/3, DisplayPort,<br>USB-C, OPS |
| 3840 x 2160 | 135                        | 60                      | HDMI1/2, DisplayPort, USB-C           |

**HDMI/ DisplayPort/ OPS (DTV) Support mode**

| Resolution | Horizontal frequency (kHz) | Vertical frequency (Hz) | Remark                      |
|------------|----------------------------|-------------------------|-----------------------------|
| 480/60p    | 31.5                       | 60                      |                             |
| 576/50p    | 31.25                      | 50                      |                             |
| 720/50p    | 37.5                       | 50                      |                             |
| 720/60p    | 45                         | 60                      |                             |
| 1080/50i   | 28.1                       | 50                      |                             |
| 1080/60i   | 33.75                      | 60                      |                             |
| 1080/50p   | 56.25                      | 50                      |                             |
| 1080/60p   | 67.432                     | 59.94                   |                             |
| 1080/60p   | 67.5                       | 60                      |                             |
| 2160/30p   | 67.5                       | 30                      | HDMI1/2/3, DisplayPort, OPS |
| 2160/50p   | 112.5                      | 50                      | HDMI1/2, DisplayPort        |
| 2160/60p   | 135                        | 60                      | HDMI1/2, DisplayPort        |



**! NOTE**

- Horizontal frequency: The horizontal interval is the time taken to display one horizontal line. When 1 is divided by the horizontal interval, the number of horizontal lines displayed every second can be tabulated as the horizontal frequency. The unit is kHz.
- Vertical frequency: The product display functions by the screen image changing dozens of times every second like a fluorescent lamp. The vertical frequency or refresh rate is the number of image displays per second. The unit is Hz.

| Wireless module (LGSBWAC92) Specifications   |                           |
|--|---------------------------|
| Wireless LAN (IEEE 802.11a/b/g/n/ac)   |                           |
| Frequency range (MHz)  | Output power (Max.) (dBm) |
| 2400 to 2483.5   | 18                        |
| 5150 to 5725   | 18                        |
| 5725 to 5850   | 12                        |
| Bluetooth  |                           |
| Frequency range (MHz)  | Output power (Max.) (dBm) |
| 2400 to 2483.5   | 8                         |
| <ul style="list-style-type: none"> <li>As band channels can vary per country, the user cannot change or adjust the operating frequency. This product is configured for the regional frequency table.</li> <li>For consideration of the user, this device should be installed and operated with a minimum distance of 20 cm between the device and the body.</li> </ul> |                           |

(Only Nigeria)

**Connection and use of this communication equipment is permitted by the Nigerian Communications Commission.**

(Only Hong Kong)

| Wireless module (LGSBWAC92) Specifications   |                           |
|--|---------------------------|
| Wireless LAN (IEEE 802.11a/b/g/n/ac)   |                           |
| Frequency range (MHz)  | Output power (Max.) (dBm) |
| 2400 to 2483.5   | 18                        |
| 5150 to 5350   | 18                        |
| 5725 to 5850   | 12                        |
| Bluetooth  |                           |
| Frequency range (MHz)  | Output power (Max.) (dBm) |
| 2400 to 2483.5   | 8                         |
| <ul style="list-style-type: none"> <li>As band channels can vary per country, the user cannot change or adjust the operating frequency. This product is configured for the regional frequency table.</li> <li>For consideration of the user, this device should be installed and operated with a minimum distance of 20 cm between the device and the body.</li> </ul> |                           |

(Only Vietnam)

| <b>Wireless module (LGSBWAC92) Specifications</b>  |                                  |
|--|----------------------------------|
| <b>Wireless LAN (IEEE 802.11a/b/g/n/ac)</b>  |                                  |
| <b>Frequency range (MHz)</b>   | <b>Output power (Max.) (dBm)</b> |
| 2400 to 2483.5   | 17.5                             |
| 5150 to 5350   | 17.5                             |
| 5725 to 5850   | 12                               |
| <b>Bluetooth</b>   |                                  |
| <b>Frequency range (MHz)</b>   | <b>Output power (Max.) (dBm)</b> |
| 2400 to 2483.5   | 8                                |
| <ul style="list-style-type: none"> <li>As band channels can vary per country, the user cannot change or adjust the operating frequency. This product is configured for the regional frequency table.</li> <li>For consideration of the user, this device should be installed and operated with a minimum distance of 20 cm between the device and the body.</li> </ul> |                                  |

(Only Philippines)

| <b>Wireless module (LGSBWAC92) Specifications</b>  |                                  |
|--|----------------------------------|
| <b>Wireless LAN (IEEE 802.11a/b/g/n/ac)</b>  |                                  |
| <b>Frequency range (MHz)</b>   | <b>Output power (Max.) (dBm)</b> |
| 2400 to 2483.5   | 18                               |
| 5150 to 5725   | 18                               |
| 5725 to 5850   | 18                               |
| <b>Bluetooth</b>   |                                  |
| <b>Frequency range (MHz)</b>   | <b>Output power (Max.) (dBm)</b> |
| 2400 to 2483.5   | 8                                |
| <ul style="list-style-type: none"> <li>As band channels can vary per country, the user cannot change or adjust the operating frequency. This product is configured for the regional frequency table.</li> <li>For consideration of the user, this device should be installed and operated with a minimum distance of 20 cm between the device and the body.</li> <li>FCC ID: BEJLGSBWAC92 / IC: 2703H-LGSBWAC92</li> </ul> |                                  |

## LICENCE

Supported licenses may differ by model. For more information of the licenses, visit [www.lg.com](http://www.lg.com).



The terms HDMI, HDMI High-Definition Multimedia Interface, HDMI trade dress and the HDMI Logos are trademarks or registered trademarks of HDMI Licensing Administrator, Inc.

Manufactured under license from Dolby Laboratories. Dolby, Dolby Vision, Dolby Vision IQ, Dolby Audio, Dolby Atmos, and the double-D symbol are trademarks of Dolby Laboratories Licensing Corporation.

For DTS patents, see <http://patents.dts.com>. Manufactured under license from DTS Licensing Limited. DTS, the Symbol, & DTS and the Symbol together, DTS 2.0 Channel, DTS 2.0+Digital Out, DTS-HD, and DTS Virtual:X are registered trademarks or trademarks of DTS, Inc. in the United States and/or other countries. © DTS, Inc. All Rights Reserved.



The Bluetooth® word mark and logos are registered trademarks owned by Bluetooth SIG, Inc. and any use of such marks by LG Electronics Inc. is under license. Other trademarks and trade names are those of their respective owners.



The model and serial number of the product are located on the back and on one side of the product. Record them below in case you ever need service.

MODEL \_\_\_\_\_  
SERIAL NO. \_\_\_\_\_



This product qualifies for ENERGY STAR®.

Changing the factory default configuration and settings or enabling certain optional features and functionalities may increase energy consumption beyond the limits required for ENERGY STAR® certification.

Refer to [ENERGYSTAR.gov](http://ENERGYSTAR.gov) for more information on the ENERGY STAR® program.

Temporary noise is normal when powering ON or OFF this device.