

Hx4 Multi Display Controller

USER GUIDE

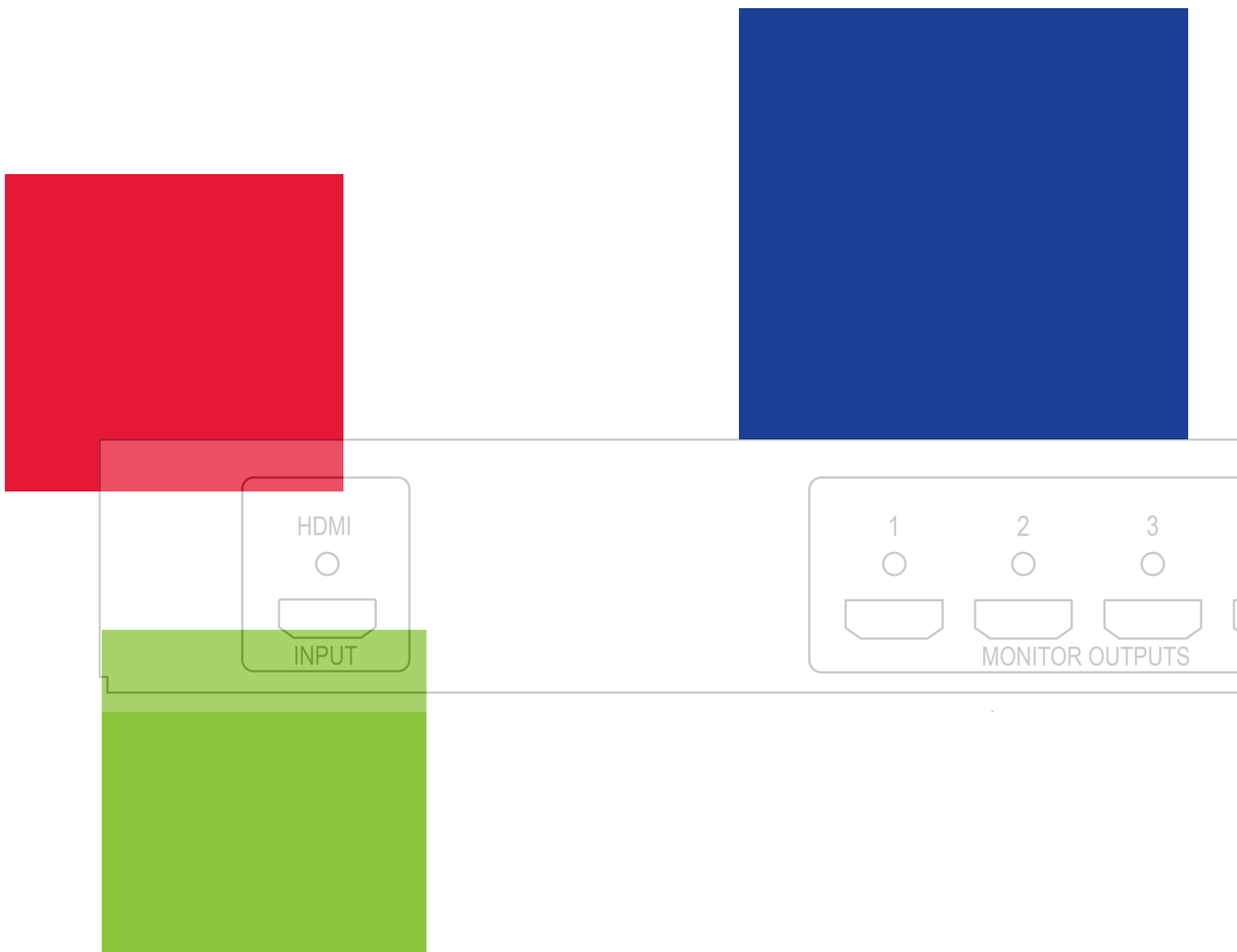

Table of Contents

Disclaimer/Copyright Statement.....	4
Quick Start Guide.....	5
Contents.....	5
Step 1 - Connecting the Input.....	5
Step 2 - Connecting the Outputs.....	5
Step 3 - Connect a Mains Cable.....	6
Step 4 - Connecting to a PC.....	6
Step 5 - Configure Via a Network.....	6
Step 6 - Wall Designer.....	7
Step 7 - Operation.....	8
Step 8 - Multiple Devices.....	8
Step 9 - Rack Mounting (Optional).....	9
Step 10 - IP Control Panel.....	9
Step 11 - Trouble Shooting.....	9
Chapter 1 - Introduction.....	10
1.1 Introduction.....	10
1.2 How the User Guide is Organised.....	10
1.3 Fonts and Symbols.....	10
Chapter 2 - Safety.....	11
2.2 Unpacking and Initial Inspection.....	11
Chapter 3 - General.....	13
3.1 Overview.....	13
3.2 Features.....	13
Chapter 4 - Hardware.....	14
4.1 Front Panel.....	14
4.2 Rear Panel.....	14
4.3 Rack Mounting the Hx4.....	15

Chapter 5 - Software	16
5.1 Wall Designer.....	16
5.2 Wall Designer Features.....	16
5.3 Installing Wall Designer	16
5.4 Installing the Wall Designer - Mac OS.....	17
5.5 Running the Wall Designer Application.....	18
Chapter 6 - Cabling	20
6.1 Attaching an HDMI Cable Lock.....	20
6.3 Connecting Your Input Source.....	20
Chapter 7 - Operation	22
7.1 Setting up the Hx4.....	22
7.2 Switching On the Hx4.....	22
7.3 Configuring the Hx4 via USB.....	23
7.4 Configuring the Hx4 via a Network.....	25
Chapter 8 - Troubleshooting	26
8.1 Troubleshooting.....	26
Chapter 9 - Maintenance	27
9.1 Maintenance of the Hx4.....	27
Chapter 10 - Environmental	28
10.1 Certification and Compliances.....	28
Chapter 11 - Specifications	29
Chapter 12 - Warranty/RMA	30
12.1 Warranty Statement.....	30
12.2 RMA Returns Policy.....	30
Chapter 13 - Index	32

Disclaimer/Copyright Statement

© Datapath Ltd., England, 2018

Datapath Limited claims copyright on this documentation. No part of this documentation may be reproduced, released, disclosed, stored in any electronic format, or used in whole or in part for any purpose other than stated herein without the express permission of Datapath Limited.

Whilst every effort is made to ensure that the information contained in this Quick Start Guide is correct, Datapath Limited make no representations or warranties with respect to the contents thereof, and do not accept liability for any errors or omissions. Datapath reserves the right to change specification without prior notice and cannot assume responsibility for the use made of the information supplied. All registered trademarks used within this documentation are acknowledged by Datapath Limited.

Quick Start Guide

A version of the Quick Start Guide is included for your convenience.

Contents

- The Hx4 Multi Display Controller
- 1 x Mains power cable
- USB 2.0 cable Type A to Type B
- Quick Start Guide
- HDMI Locks x 5
- 2 x Rack mount attachments
- 6 x Rack mount screws

If any of the items are missing, please contact Datapath for further instructions.

The Hx4 is not supplied with input and output cables therefore please ensure you have the relevant cables to hand to complete your project.

Step 1 - Connecting the Input

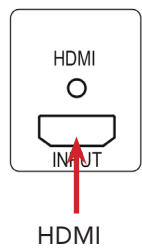

Connect your input source to the input connector on the rear of the Hx4. Ensure cables are inserted correctly, it is recommended that locking cable connectors are used.

Step 2 - Connecting the Outputs

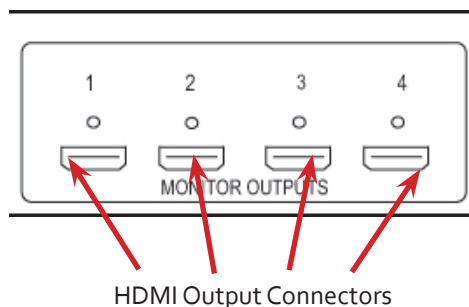

Connect the monitor cables to the monitor output connectors on the rear of the Hx4, you can connect up to 4 displays to a single Hx4 unit. Ensure the cables are inserted correctly, it is recommended that locking connectors are used.

Step 3 - Connect a Mains Cable

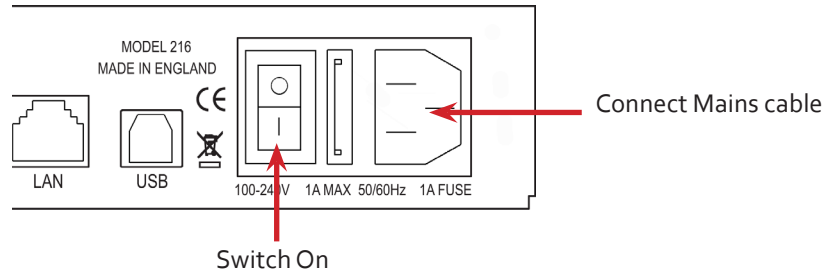

When the power is switched on the Hx4 will boot and the LEDs on the front panel will flash for up to 15 seconds. Should the LED's continue to flash see the troubleshooting section.

Step 4 - Connecting to a PC

To successfully configure the Hx4, first install the Wall Designer application on your PC by downloading the latest version from the Datapath website: www.datapath.co.uk.

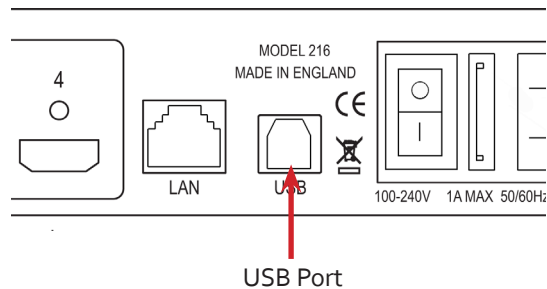

When the Hx4 has booted, connect it to your PC using the USB cable provided. The Hx4 unit is a plug and play device, Wall Designer will detect it when the layouts are configured.

The Hx4 can also be configured via a Network, see Step 5.

Step 5 - Configure Via a Network

The Hx4 has a single ethernet port to allow users to add the device to their network.

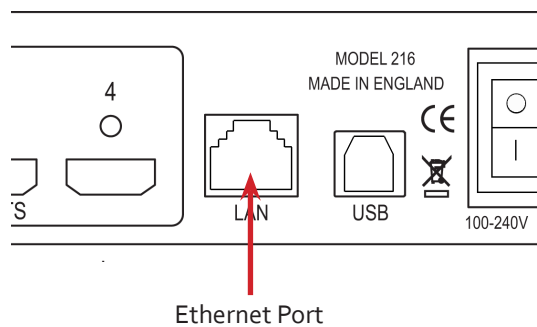

Connect the Hx4 to a network using the LAN connector then open Wall Designer and create your display layout. At the point where you associate the virtual device with a physical device the list will display all Hx4's currently connected to the network.

Click on the virtual device to display its properties, the Device Properties can be changed in the same way as if connecting via USB. Once any changes have been made click on Apply Settings to save.

See the Hx4 User Guide for information regarding network settings.

Step 6 - Wall Designer



Start | All Programs | Wall Designer |

When Wall Designer is opened the following dialogue is displayed:

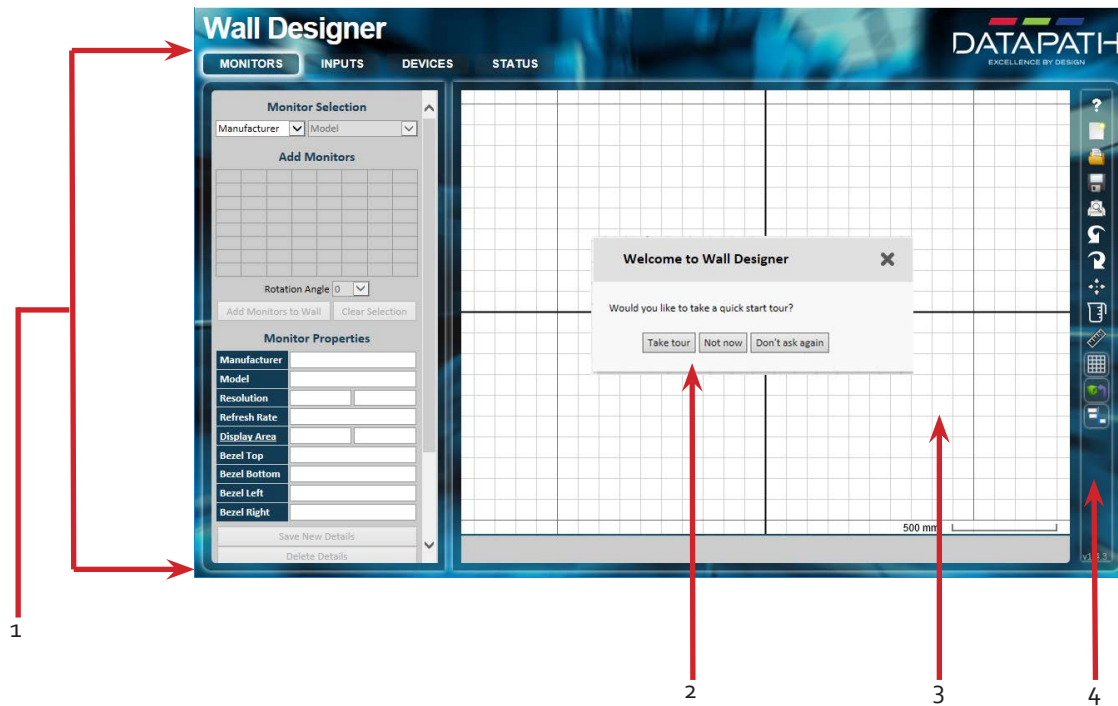

1	Operation Modes: Select monitors, inputs and configure devices
2	Quick Tour Dialogue
3	Virtual Canvas
4	Toolbar

It is highly recommended that when using Wall Designer for the first time, all users take the Quick Start Tour.

Step 7 - Operation

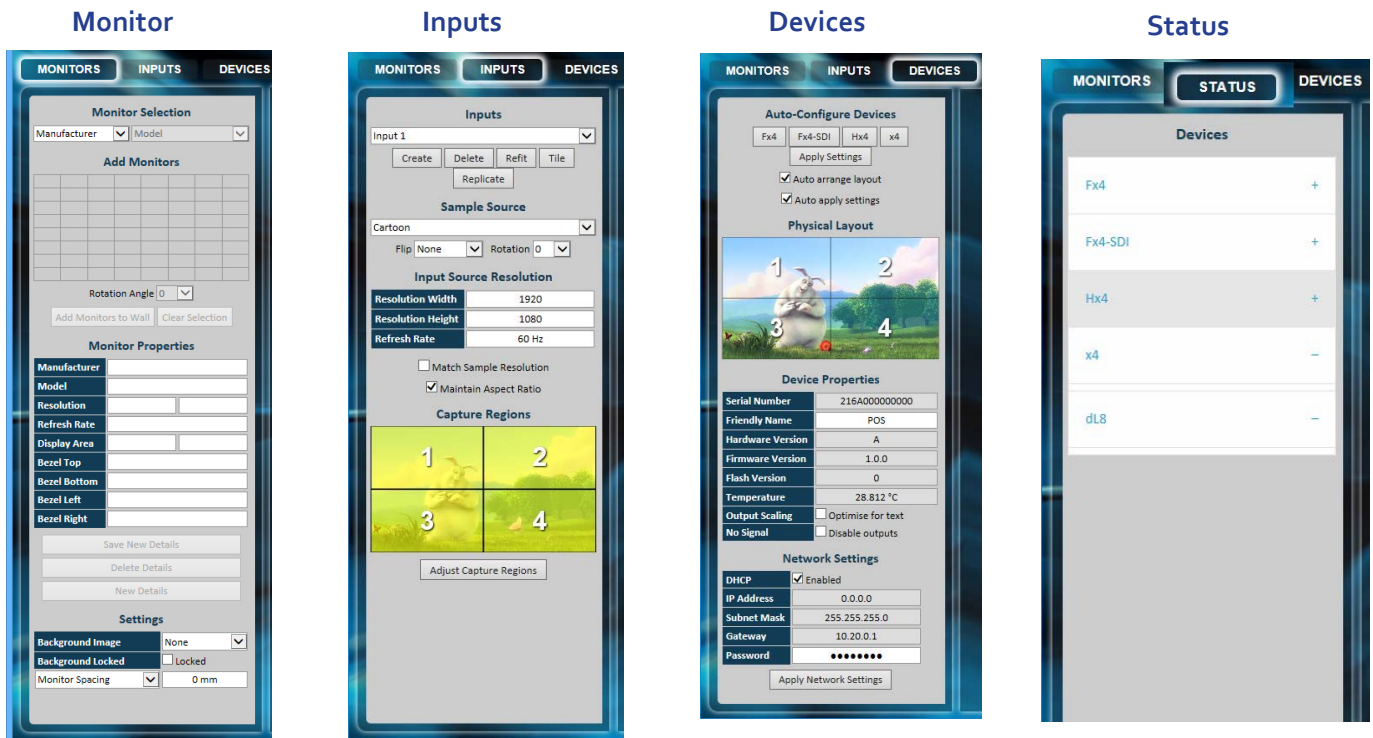

Select the monitor manufacturer from the drop down list on the left, then select the model.

Choose the number of monitors by clicking and dragging in the **Add Monitors** grid.

Select a background to enhance the Virtual Canvas

Click **Add Monitors to Wall** then open the **Inputs** tab.

Set up your input sources to be displayed on your monitors. Click on the **Create** button and select a sample source for a preview of what the display wall will look like.

Configure hardware devices by clicking on **Auto-configure Hx4**. Once you are satisfied with the configuration, right click on the virtual device in the main window and associate it with the physical device connected to your computer or on your network.

To complete the device configuration, click on the **Apply Settings** button.

Click on a device from the list and the Status Panel is populated with a detailed summary of the device including details of Flash and Firmware versions, IP Address (if connected via a network), serial number and average temperature of the device etc.

The Status Panel also displays the input and output properties, a detailed view of each property can be viewed by clicking on each drop-down menu.

Step 8 - Multiple Devices

Where more than four outputs are required, (the example below shows eight) the Auto Config Hx4 function will determine the most logical way to connect all devices. To daisy chain a second Hx4, use HDMI Distribution Amplifier as shown below.



Step 9 - Rack Mounting (Optional)

Remove the stud screws on the side of your Hx4 and secure the rack mounts using the screws provided

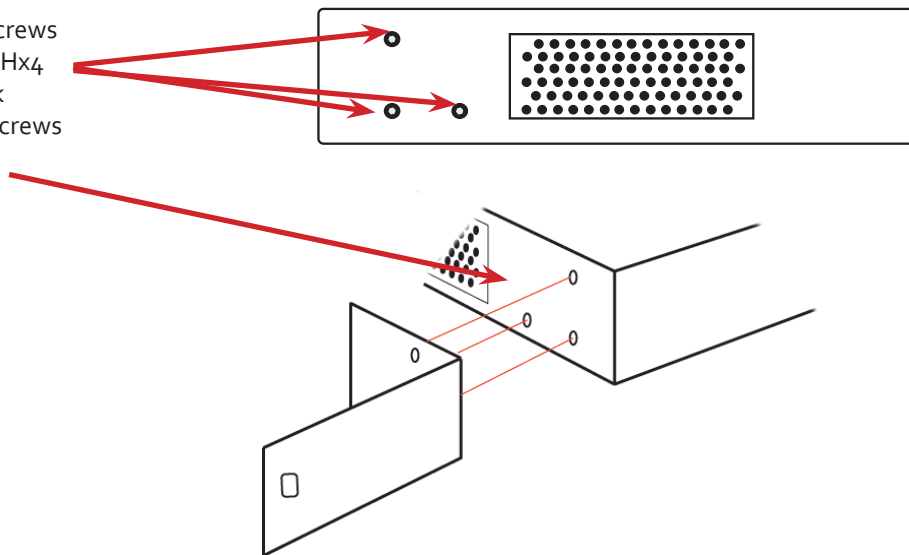

Step 10 - IP Control Panel

The Hx4 has a control panel that can be accessed via an IP connection, simply type in the IP address of the Hx4 into an Internet browser and a control panel for that particular Hx4 is displayed. The control panel allows you to change properties and settings, manually define cropping regions or open the Wall Designer application.



Step 11 - Trouble Shooting

Display Screens Turn Red

If all the display screens turn red, this indicates that there is an issue with HDCP compliance. Check both the input source and the monitors are HDCP compliant.

Front Panel LED Lights

On start-up all three lights will flash, after a few seconds the flashing should stop and the power light stays on permanently. If the light continues to flash this indicates that the Hx4 requires upgrading. See User Guide for details on how to upgrade your Hx4.

Chapter 1 - Introduction

1.1 Introduction

Congratulations on your purchase of the Datapath Hx4 Multi Display Controller. The Hx4 has been manufactured and tested to the highest standards offering unparalleled quality and reliability. The aim of this user guide is to assist you through the installation of the Hx4 safely and effectively and act as a reference guide for future use. Do not switch the controller on until all the relevant cables have been connected.

1.2 How the User Guide is Organised

The user guide is broken down into chapters and each chapter into sections. Chapters, sections and pages are numbered individually. Pages are numbered in Arabic numerals with the exception of the cover page (no numbering).

1.3 Fonts and Symbols

1.3.1 Fonts



The font used throughout the user guide is Corbel however the following font styles mean:

Bold = Used to describe menu titles, buttons in software or elements that you must type.

Blue Underlined = Indicates a hyper-link. Some hyper-links may be linked to live websites.

1.3.2 Symbols

Symbols are used throughout this user guide to assist the user in quickly identifying important safety information and notes.

	Yellow triangle indicates that failure to observe the instructions could result in injury and/or damage to the system.
	White arrow in a blue box indicates a useful tip.
	White exclamation mark in a blue box indicates important information.

Chapter 2 - Safety



2.1 Safety Precautions

To prevent damage to your Datapath product or injury to personnel operating the equipment, please read the following safety precautions prior to operation. These instructions should be made available to all those who will use and operate Datapath products.

2.1.1 Power Supply

All Datapath products require a mains power supply. This power supply must be disconnected when equipment is being relocated.

2.1.2 Cables

Do not expose cables to any liquids; doing so may cause a short circuit which could damage the equipment. Do not place heavy objects on top of any cables as this can cause damage and possibly lead to exposed live wires.

2.1.3 Ventilation

The Hx4 should be located in a well ventilated area. All ventilation holes on the casing must be kept clear of any obstruction at all times. Failure to do so will result in the system over heating and damaging your equipment.

2.1.4 Working Environment

The equipment should be located in an environment free from dust, moisture and extreme changes in temperature and should be placed on a stable and solid work surface. Liquids (hot/cold drinks etc) should not be placed near the equipment as spillage could cause serious damage.

2.1.5 Gas/Flammable Liquids

Electronic equipment should never be used in the presence of gas or any flammable liquid, doing so could result in an explosion or serious fire.

2.1.6 Smoke/Unusual Smells

Should you notice smoke or unusual smells being emitted from your system, turn off and unplug the system from the mains supply. The system should then be passed to a qualified technician for inspection. Continued operation could result in personal injury and damage to property.

2.1.7 Maintenance

Apart from what is detailed in this user guide, maintenance should only be carried out by competent technicians, Hx4's that are physically damaged should be returned to Datapath for repair using Datapath RMA procedures.

2.2 Unpacking and Initial Inspection

2.2.1 Unpacking

All packaging materials should be retained for future transit.

2.2.2 Initial Inspection

All Datapath products are carefully prepared for shipment and every effort is made to ensure you receive the product in pristine condition. On receipt, you should carefully inspect the outer packaging for any transit damage i.e. any signs that the item may have been dropped etc.

Use the product leaflet enclosed to establish that all the items are present. Should any items be missing, contact Datapath for further instructions.

Check the Hx4 for damage that could have an adverse affect on the operation of the system or could cause injury to the operator. Should there be any physical damage to the power sockets or exposed wiring do not connect to a power source, contact Datapath for further instructions.

2.3 Unpacking

Your packing box should contain the following items:

- The Hx4 Multi Display Controller
- 1 x Mains power cable
- USB 2.0 cable Type A to Type B
- Quick Start Guide
- HDMI Locks: x 5
- 2 x Rack mount attachments
- 6 x Rack mount screws

If any of the items are missing, please contact Datapath for further instructions.

Chapter 3 - General

3.1 Overview

Advancements in digital signage requirements mean that customers demand greater freedom in creating and deploying small, medium and large scale signage projects. The Datapath Hx4 is a stand-alone display wall controller with the capacity to run a single 4K HDMI source across four HD outputs in high definition. When used with the powerful Wall Designer application software, the Hx4 can represent any arrangement or configuration of the source image desired.

A popular choice for advertising boards, corporate signage and live event visuals, this cost effective control system is both easy to use and simple to set up. When paired with a HDMI distribution amplifier, large cost effective display walls can be achieved.

Hx4 has a single ethernet connection, which can be used for status monitoring and complete control of the hardware. A flexible REST API is also supported to allow third party software integration.

3.2 Features

Each output monitor can take its input from any region of the input image as all of the required cropping, scaling, rotation and frame-rate conversion is handled by the Datapath Hx4 hardware. These regions can overlap to allow any output to replicate another or can be configured to support any creative splice of the source material. This allows the support of many non-rectangular screen arrangements with correction for uneven gaps, and any mix of monitor orientations.

- Infinite creative configurations
- Up to Ultra HD input, four HD 1080p outputs
- Rotates, crops, mirrors and bezel corrects
- Supports up-scaling, (down-scaling not supported).
- Single HDMI 1.4 for 4k 30 fps source capture
- HDCP support on all inputs and outputs
- Gen-lock and frame-lock for tear free display
- Stand alone operation: Non-volatile configuration can adapt to changes in inputs by automatically adjusting all scale factors
- Network or USB interfaces allow platform independent control (Windows® & MAC OS X 10.12 & later)
- Power down configuration save facility, power up instantly with no re-setup required

Chapter 4 - Hardware

4.1 Front Panel

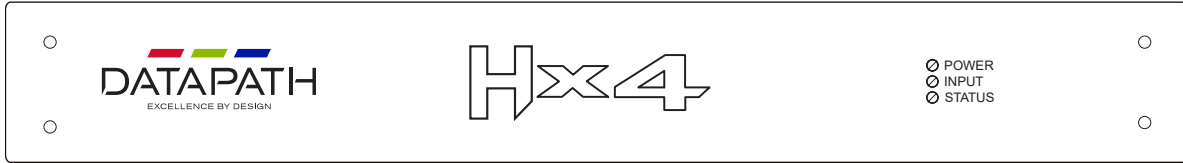

4.1.1 Operation Indicators

The front panel has three LEDs to indicate the operational status of the Hx4:

- Power
- Input
- Status

Power

When illuminated, the Power LED indicates the Hx4 is connected to a mains supply.



The LED's can flash for up to 15 seconds when the Hx4 is switched on.

Input

When illuminated, the Input LED indicates a valid source is connected.

Status

Continuous illumination – Indicates the Hx4 is operating normally.

Flashing – Unit is operating over the normal operating temperature. Ensure the input fan vent is not blocked.

If the Status LED goes off and remains off this indicates that the settings configured in Wall Designer no longer match the input, this is normally the result of a change of input. The Hx4 will compensate for the settings and reconfigure itself to display as near to the settings as possible. The output will still be displayed but not necessarily as expected.

When the Hx4 device is connected to a PC by a USB cable and Wall Designer application is active, then all three lights flash in turn to help to identify which unit is being controlled.

4.2 Rear Panel

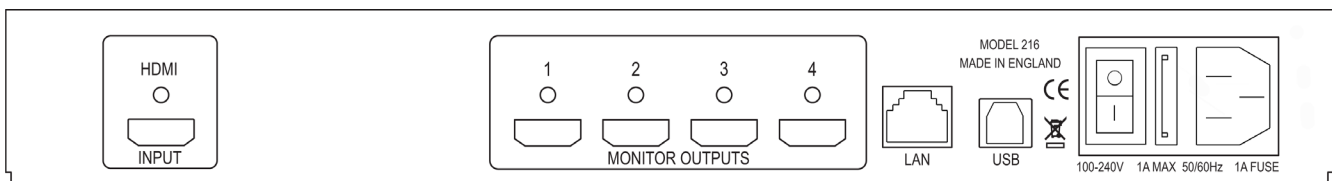

Input

The Hx4 has a single HDMI 1.4 input connector.

Monitor Outputs

Four HDMI output connectors. The Monitor Output connectors are used to connect the Hx4 to the display monitors.

LAN

The LAN connector is used to connect the Hx4 to a network for configuration and control. The LAN connector can also be used to connect the Hx4 directly to a PC for configuration.

USB

The USB socket is used to connect the Hx4 to a PC via a USB connection using the supplied USB Type A to Type B cable.

4.3 Rack Mounting the Hx4

The Hx4 is supplied with attachments to enable you to mount the Hx4 in a rack. Remove the 3 mounting screws on each side of the Hx4 using a cross head screwdriver and attach the rack mounts as shown in the illustration below.

Remove the stud screws and secure rack mounts using the screws provided

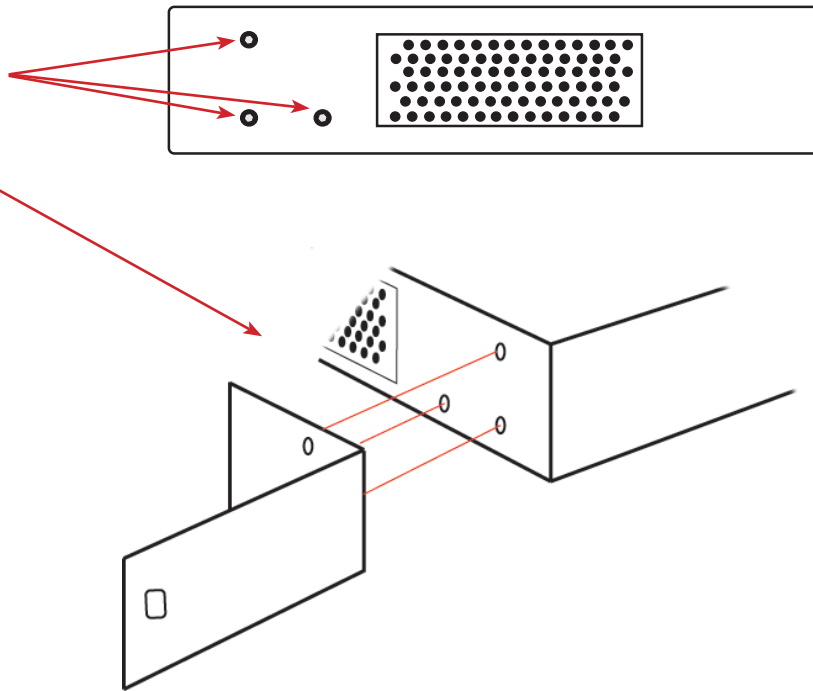

Chapter 5 - Software

This chapter will cover:

Introduction to Wall Designer

Installing the Wall Designer application

Running the Wall Designer application

A summary of Wall Designer features

5.1 Wall Designer

Multi-Monitor Display Wall installations can be challenging to design, build, configure and implement. Highly creative display projects often require multiple monitors arranged in unconventional formations with a myriad of bezel sizes, gaps and monitor positions. Project designers, installers and integrators require simple yet effect Video Wall creation tools in order to manage the project from start to finish.

The software includes a community driven database of monitors from popular manufacturers which continues to grow as users add their own monitor specifications and submit them back to Datapath for inclusion in the next database update.

5.2 Wall Designer Features

Wall Designer is the perfect solution to creating and managing your display wall project from start to finish, giving you total creative control reliably and efficiently.

- Datapath's monitor database is regularly updated with new manufacturers and models. Users can add and submit their own monitor information and once validated, will be added to the master database.
- Monitors can be arranged landscape and portrait with gaps.
- Add content into your project and place it across the virtual canvas filling the monitors with content.
- Automatically configure the Hx4 assigning each output to a monitor.
- Print out design schematics to aid physical monitor installation.
- Language support for German, Spanish, French, Japanese, Polish, Portuguese, Russian and Simplified Chinese.
- Comprehensive help files to guide you through the application.

5.3 Installing Wall Designer

5.3.1 Downloading The Application

The Wall Designer application should be downloaded from the Support/Downloads pages of the [Datapath website](#) under the Display Controller Downloads section.

5.3.2 View Readme

Click on View Readme to open an HTML document containing the latest information and bug fixes for the application. The Wall Designer application can be installed from the Readme.

5.3.3 Install the Wall Designer Software

Double click on the downloaded Wall Designer.exe file to initiate the installation wizard. Wall Designer is a multi-lingual application and you are offered a selection of languages when the install process begins. Select the required language and the install wizard will continue installing the software.

5.4 Installing the Wall Designer - Mac OS

5.4.1 Web Download

The Wall Designer application for Mac is available to download from the [Datapath website](#). Once the application has been downloaded, locate and click on the walldesigner.dmg in your downloads folder and the following dialogue is displayed:

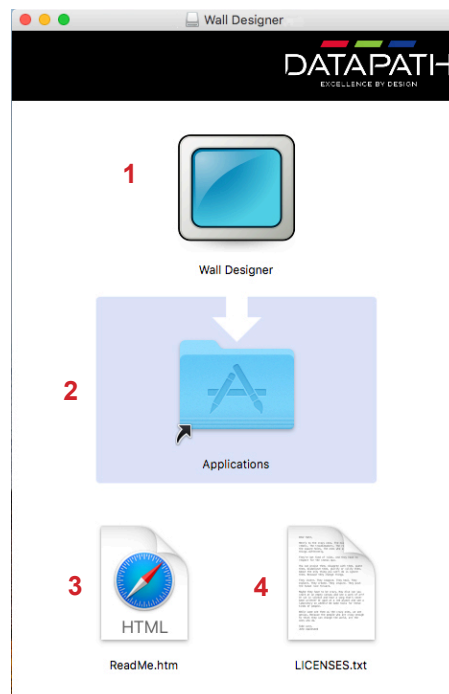

Drag the Wall Designer application (1) into the Application folder (2) and the Wall Designer application becomes available to open from Launchpad.

The ReadMe (3) and the Software License Agreement (4) can be opened by clicking on them. You are strongly advised to read both prior to using the Wall Designer application.

5.5 Running the Wall Designer Application

Once the software has been installed you can open the application:

Start | All Programs | Wall Designer (Windows) or Launchpad | Wall Designer (Mac)

5.5.1 Wall Designer Interface

When Wall Designer is opened, the following dialogue is displayed:

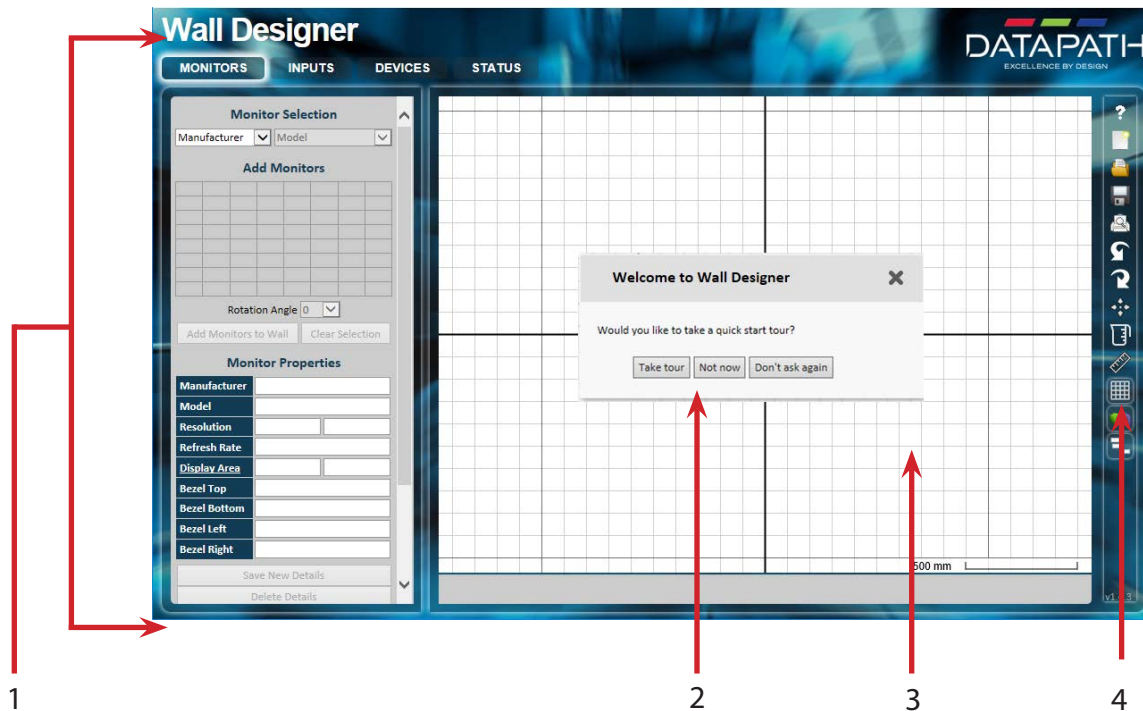

1	Operation Modes: Select monitors, inputs, configure devices and check the status of the device.
2	Quick Tour Dialogue
3	Virtual Canvas
4	Toolbar

5.5.2 Operation Modes

The application has 4 separate operation modes: Monitor, Inputs, Devices and Status:

Monitors

Wall Designer includes a database containing a selection of the more commonly used monitor manufacturers and models. Use the manufacturer and models dropdown list to select a specific monitor. When selected the monitor properties are automatically populated with the specification of the monitor.

To add monitors simply click or click and drag the cells inside the 8x8 grid. Once the monitors have been arranged on the virtual canvas and you are happy with the wall design, click on Add Monitors to Wall.

Add a background image to enhance the Virtual Canvas.

Inputs

The inputs section of the application toolbar enables you to select a given input and allocate regions of the input to each monitor on the display wall.

A collection of sample sources are available via a dropdown menu, this contains a list of images and videos contained within the application's and user's media folder.

Devices

The devices section of the application toolbar brings together the input, hardware devices and the monitors thereby completing the design of your display wall. This is done by allocating the input to available devices and the outputs from the devices to specific monitors on the display wall.

For ease of use Wall Designer has an automatic configuration feature (Auto-config) which when clicked, automatically adds the required number of devices and configures all the links from the input to the monitors via your Hx4's in the most logical configuration.

The virtual device can be associated with an actual device by right clicking on it and selecting **Associate Device**. Click in the device to display the device properties, these properties can be changed if required, for example the **Friendly Name** (recommended).

Status

Click on a device and the Status Panel is populated with a detailed summary of the device including details of Flash and Firmware versions, IP Address (if connected via a network), serial number and average temperature of the device etc.

The Status Panel also displays the input and output properties, a detailed view of each property can be viewed by clicking on each drop-down menu.

5.5.3 Quick Tour

When opening the application for the first time a quick tour dialogue is presented. It is highly recommended that you take a few minutes to complete the tour. The quick tour dialogue can be turned off so it will not be displayed in the future.

5.5.4 Virtual Canvas

The Virtual Canvas displays a representation of the monitors selected and their orientation, thereby offering a view of the completed wall design. In Device mode, the Virtual Canvas illustrates how the input source, Hx4(s) and monitors are configured.

5.5.5 Toolbar

The toolbar offers a group of tools which assist in creating, opening and saving layouts, you can also display actual video wall measurements in metric or imperial.

5.5.6 Help Files

The Wall Designer application has an inbuilt help file system which can be accessed by clicking on the ? at the top of the toolbar.

Chapter 6 - Cabling

This chapter will cover:

Attaching HDMI Cable Lock.

Connecting input sources.

Connecting a loop-through output cable.

Connecting the outputs to monitors

Cable lengths

6.1 Attaching an HDMI Cable Lock

The Hx4 is supplied with HDMI cable locks which should be used on non lockable HDMI cables to ensure they remain firmly attached to the Hx4.



Thread the cable tie through the holes in the side of the cable lock.

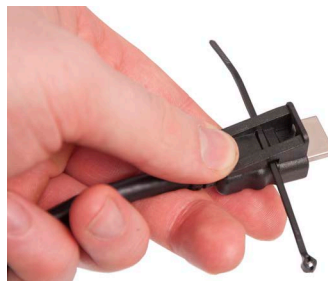

Sit the cable lock on the top of the HDMI cable connector ensuring the cable lock is flush with the front of the shroud on the HDMI connector.



Pull the cable tie tightly and ensure it fits firmly on the HDMI connector shroud.

6.3 Connecting Your Input Source

The Datapath Hx4 has one dedicated HDMI input connector. It is strongly recommended that locking cables are used to prevent the input source cable from becoming detached from the Hx4. HDMI Cable Locks are provided and should be attached to your cables as shown above:



Connecting an HDMI Input Cable

6.5 Connecting Outputs to Monitors

Each Hx4 display controller can support up to 4 monitors on a display wall, the output connectors are HDMI. Once again it is highly recommended that locking cables are used.

Each output can display any region of the input image, all the required cropping, scaling and rotations are calculated within the Hx4 hardware.



Connecting HDMI Output Cable

6.5.1 Cable Lengths

Workable cable lengths depend on the quality of the cables used to set up your Hx4, Datapath recommends using certified cables when installing your Hx4.

Cable Type	Maximum Length (m)
HDMI (output)	10
Ethernet Cable (Network/Setup)	100
USB (Setup)	3

Chapter 7 - Operation

This chapter will cover:

- Setting up the Hx4
- Switching on the Hx4
- Configuring the Hx4 using a USB connection
- Configuring the Hx4 over a Network

7.1 Setting up the Hx4

7.1.1 Connecting an Input

Firstly, ensure you have all the relevant input and output cables you need for your project:

- Begin by connecting your input source to the input connector on the rear of the Hx4. Ensure the input cable is inserted correctly, it is recommended that a cable locking connectors is used.

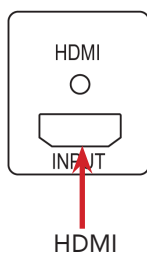

7.1.2 Connecting Outputs

The Hx4 has four output connectors.

- Connect the monitor cables to the monitor output connectors on the rear of the Hx4, you can connect up to four monitors to a single Hx4 unit. Ensure the cables are inserted correctly, it is recommended that cable locking connectors are used.

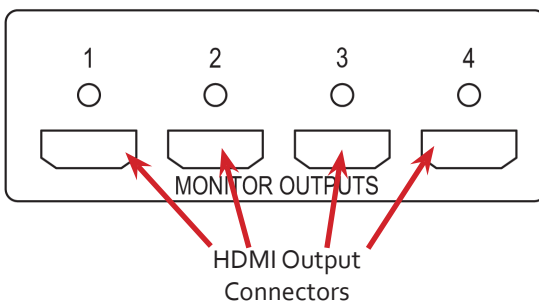

7.2 Switching On the Hx4

The Hx4 has a built in power unit which is controlled using the power switch on the rear panel. Connect in the power cable supplied with your Hx4 and plug in to a mains supply. Switch on the power on the rear of the Hx4 as shown in the following illustration:

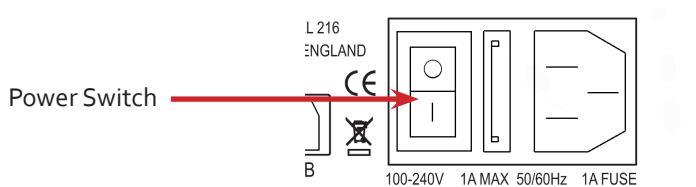

When the power is switched on the Hx4 will boot and the LEDs on the front panel will flash as described in [Chapter 4](#).

Please note, it could take up to 15 seconds for the Hx4 to fully boot.

7.3 Configuring the Hx4 via USB

When the Hx4 has booted, connect it to the computer which has the Wall Designer application installed using the USB cable provided.



The Hx4 is a plug and play device therefore relies on the device drivers in the Windows operating system. To enable the operating system to “attach” to the Hx4 you must ensure the **Device Installation Settings** are set to automatic:

Control Panel \ Devices and Printers then right click on your computer icon and select **Device Installation Settings** from the menu. In the **Device Installation Settings**, select *Yes, do this automatically (recommended)* and click on **Save Changes**.

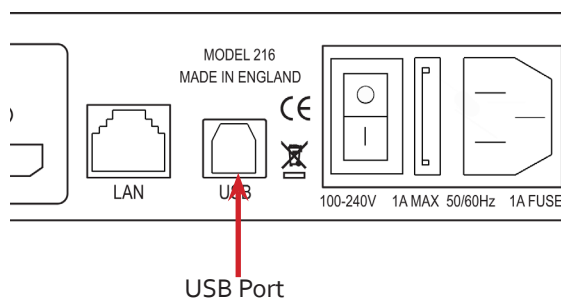

Open the Wall Designer application and begin to design your video wall layout using the **Monitors** tab as described in [Chapter 5](#).

With the monitors selected and the layout completed select the **Input** tab. Allocate the input to the Hx4 by clicking on **Create** then selecting the required input from the drop down menu.

Once the input has been selected, navigate to the **Devices** tab, this is where the Hx4 is configured.

The **Devices** window is where the input, devices and monitors are linked to complete the design of the video wall; this is done by allocating inputs to devices and the outputs from the devices to specific monitors on the video wall.

For ease of use the **Auto-config Hx4** function will, when clicked, automatically add devices and configure all the links from the inputs to the monitors via the Hx4 in the most logical configuration.

Click on the **Auto-config Hx4** button and a visual representation of the configured Hx4 will appear in the main window, for example:

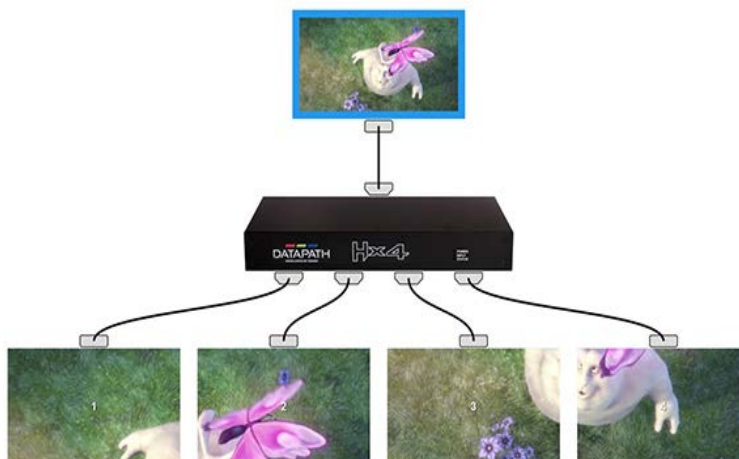

The illustration on the previous page shows the input source connected to the Hx4 and each monitor connected to the respective output connector.

Where more than four outputs are required, (the example below shows eight) the **Auto Config Hx4** function will determine the most logical way to connect all devices. . To add a second Hx4, use a HDMI Distribution Amplifier and connect additional Hx4 units as shown below.

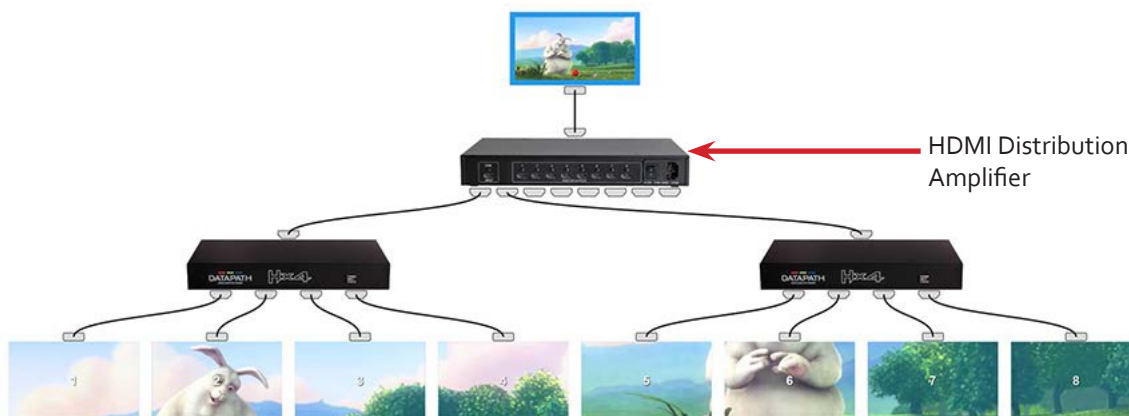

To associate the virtual Hx4 in the main window with an actual physical device, highlight the device by right clicking then select **Associate Device** from the displayed menu, a list of available Hx4's is displayed.

Click on the virtual device to display its properties, the **Device Properties** can be changed if required, for example you may wish to allocate a different Friendly Name which can be useful when connecting to multiple devices. Once changes have been made click on **Apply Settings** to save.

If no signal is detected on the input connectors the Hx4 will display a pre-configured Datapath logo.

Full instructions on how to configure your Hx4 are available in the Wall Designer application help file.

7.4 Configuring the Hx4 via a Network

The Hx4 has a single ethernet port to allow users to add the device to their network.

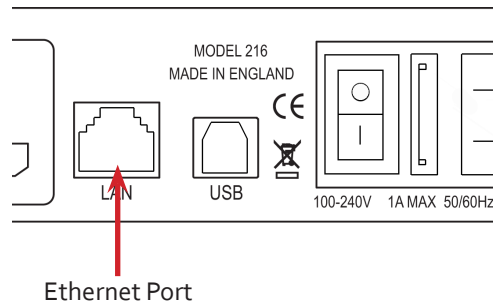

Connect the Hx4 to a network using the LAN connector then open Wall Designer and create your display layout as described in [Paragraph 7.3](#).

At the point where you associate the virtual device with a physical device the list will display all Hx4's currently connected to the network either directly or daisy chained.

Click on the virtual device to display its properties, the **Device Properties** can be changed in the same way as if connecting via USB. Once any changes have been made click on **Apply Settings** to save.

7.4.1 Network Settings

The Network Settings become active once you have successfully connected to an Hx4 either by USB or Ethernet.

The Hx4 allows you to switch between Dynamic (DHCP) and Static IP's. Out of the box, the Hx4 is configured to accept DHCP.

When DHCP is selected the network will assign the Hx4 with an IP address, this IP address can change depending on how the network allocates IP addresses.

If the Hx4 is assigned a Static IP address it will keep that address until it is changed by the user.

The IP Address, Subnet Mask and Gateway fields are not available to edit if DHCP is selected and the display settings are assigned via a DHCP server.

In Static mode the IP Address, Subnet Mask and Gateway can be manually configured.

Chapter 8 - Troubleshooting

8.1 Troubleshooting

8.1.1 Display Screens Turn Red

If all the display screens turn red, this indicates that there is an issue with HDCP compliance. Check both the input source and the monitors are HDCP compliant. If neither are HDCP compliant it is possible to stop the Hx4 from automatically negotiating an HDCP link by disabling HDCP in the Wall Designer application.

In the Devices tab, select the input to display the Advanced Timing Properties and uncheck the HDCP Enabled box.

8.1.2 Network Timing Out

The network connection fails and the Hx4 can't be seen in devices. Indicates that an IP address needs to be set.

8.1.3 Front Panel LED Lights

On start-up all three lights will flash, after a few seconds the flashing should stop and the power light stays on permanently. If the light continues to flash this indicates that the Hx4 requires a firmware upgrade.

To upgrade, connect the Hx4 via the USB or Network interface to a PC and open the Wall Designer application. Create a monitor layout, allocate an input and auto-configure the Hx4. When the visual representation of the Hx4 appears in the Device window a blue information icon will be displayed.

Click on the information icon for details of available upgrades.

8.1.4 Intermittent or Loss of Input Signal

If you lose your input signal or if the signal is intermittent it could mean there is a problem with the link rate between the source and the Hx4.

Check that all cables are fitted correctly.

8.2 Technical Support

Registered users can access our technical support using email and the Support Enquiry Form on our website, usually with a response within 24 hours (excluding weekends).

8.2.1 Email

Send an email to support@datapath.co.uk with as much information about your system as possible. To enable a swift response our support team will need to know the following details:

- Serial number of your Hx4.
- Version of Wall Designer.
- Firmware version.
- Details of the input source including any distribution amplifiers
- The exact nature of the problem - please be as specific as possible.

Chapter 9 - Maintenance

9.1 Maintenance of the Hx4

Your Hx4 requires little maintenance however care should be taken to keep all ventilation holes clear to allow an unrestricted flow of air through the unit.

Note:

Failure to keep ventilation holes clear could result in damage to your Hx4 and invalidate the warranty.

Chapter 10 - Environmental

10.1 Certification and Compliances

10.1.1 CE



EU- Class A Declaration of Conformity

Datapath Ltd declares that this Hx4 Display Controller complies with the essential requirements and other relevant provisions of Directives 2014/30/EU, 2014/35/EU and 2011/65/EU.

A copy of our Declaration of Conformity is available on request:

Datapath Ltd
Bemrose House
Bemrose Park
Wayzgoose Drive
Derby, DE21 6XQ
United Kingdom

10.1.2 FCC

These devices comply with part 15 of the FCC Rules. Operation is subject to the following two conditions: (1) These devices may not cause harmful interference, and (2) these devices must accept any interference received, including interference that may cause undesired operation.

This equipment has been tested and found to comply with the limits for a Class A digital device, pursuant to part 15 of the FCC Rules. These limits are designed to provide reasonable protection against harmful interference when the equipment is operated in a commercial environment. This equipment generates, uses and can radiate radio frequency energy and, if not installed and used in accordance with the instruction manual, may cause harmful interference to radio communications. Operation of this equipment in a residential area is likely to cause harmful interference in which case the user will be required to correct the interference at their own expense.



Caution. Changes or modifications to the equipment not expressly approved by the party responsible for compliance could void the user's authority to operate the equipment

10.1.3 Disposal

At the end of life all Datapath products should be disposed of as per local laws and regulations dictate. In the UK contact Datapath to arrange disposal. Our WEE registration number is WEEE/AA0005ZR.

Chapter 11 - Specifications

Dimensions	W 316mm x D 172mm x H 42mm (1.86kg).
Operating Temperature	0 - 35 DegC / 32 - 96 DegF.
Power Requirements	IEC switched and fused mains connector 100-240V, 50/60Hz / 30W.
Video Input Connections	1 x HDMI 1.4 (2160p/30 or equivalent up to 297 MP/s).
Video Output Connections	4 x HDMI 1.3 (1080p/60 or equivalent up to 165 MP/s).
Input Surface	4k x 4k maximum.
Genlock	HDMI Input
Control Interfaces	100BaseT Ethernet port. USB 2.0 Type B connector (full speed operation).
Firmware Support	Updates supported via USB and Ethernet connection
Storage Temperature	-20 to 70 DegC / -4 to 158 DegF
Relative Humidity	5% - 90% non-condensing
Warranty	3 years

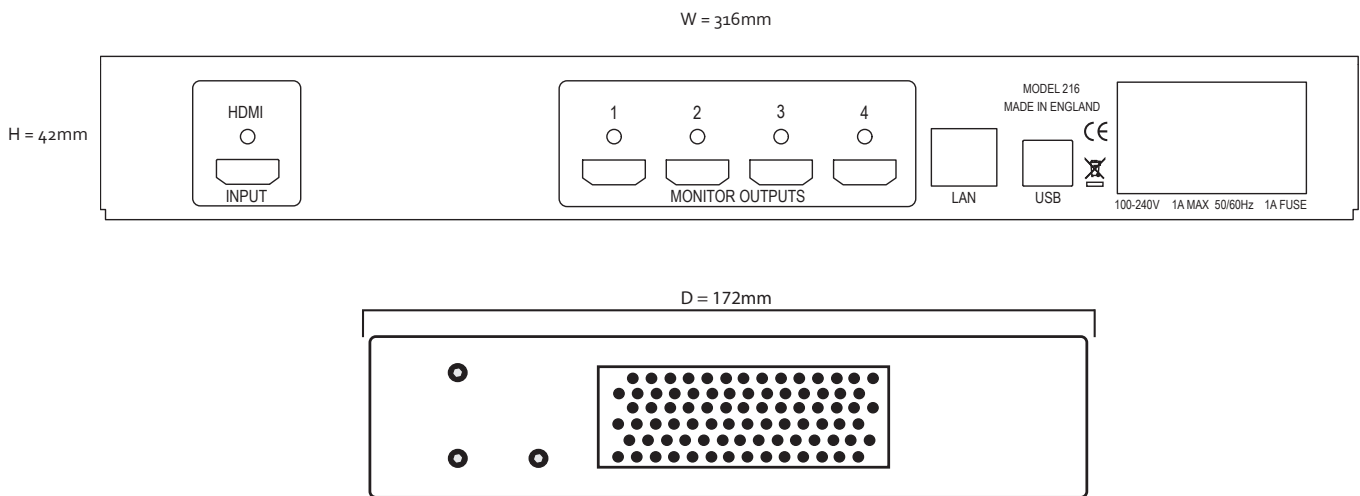

Chapter 12 - Warranty/RMA

12.1 Warranty Statement

Datapath provides a return to manufacturer warranty on all its products for a standard 36 month period. It is important that RMA procedures are followed prior to products being returned as often issues can be resolved quickly without the need for products being returned.

12.2 RMA Returns Policy

If your Datapath product is not working as you expect, we recommend that you contact Datapath Ltd in the first instance for support, since many issues that may first appear as hardware faults, are actually installation or set-up problems and can normally be resolved without having to ship any hardware back to us. This route is therefore often the quickest, easiest and cheapest way of solving the problems that you are experiencing. Please email support@datapath.co.uk including as much detail regarding the failure as possible (for example: system description, signal types, input or output resolutions and any other relevant background information).

It is essential for you to know the serial number of the product(s) when contacting us.

If it appears that the fault is most likely to be hardware related, please email rma@datapath.co.uk stating the serial number and as much additional information regarding the nature of the failure as possible. Detailed explanation of the fault will help us to better identify the problem and will direct additional focused testing if necessary. We will then issue an "RMA Number" to you.

At the time that the "RMA Number" is issued we will inform you of the warranty status of the product and the cost of the repair, if appropriate - see paragraph (b) below. The product should then be returned, at your cost, to Datapath Ltd following the steps below.

There are 4 possible scenarios when a product is returned to us:

- (a) The product is in warranty and is either found to be genuinely faulty or no fault is found. In these cases, the product will be repaired as necessary, or replaced by a new or previously repaired product, and returned to you at our cost.
- (b) The product is out of warranty and is found to be faulty. The product if possible will be repaired or replaced at fixed cost, as stated in the RMA authorisation email. To cover this payment, you will be required to either provide a Purchase Order or Credit Card details, when the product is returned to us. (However, we will not issue an invoice or charge the credit card until the repair has been completed and is about to be returned to you)
- (c) The product is in warranty but is found to be damaged by mis-use. This will be treated as (b) above.
- (d) The product is out of warranty and is obsolete. In the unlikely situation that the product can be neither repaired nor replaced, because some of its components are obsolete and we have no swap-out stock left, then the product will either be returned to you, or disposed of at your request, with no charge.

PLEASE NOTE: Datapath will not accept responsibility for the safety, integrity or security of any programmes, data or other content held on hard drives or any other type of rewritable media which is sent to us either separately or as part of any equipment returned to us for repair or for any other purpose. Customers are advised to take back-ups of anything that they deem to be valuable or important before returning the equipment to us and anything which is confidential should be erased from the media before it's returned.

Once the RMA Number has been issued, you need to raise your Purchase Order, or supply your credit card details, and return the product to: Datapath Ltd, Bemrose House, Bemrose Park, Derby DE21 6XQ, United Kingdom - securely packed and with the RMA Number clearly displayed on the outside of the box. To prevent unnecessary carriage and handling please only send back products or accessory items you believe to be faulty.

In the case of paragraph (c), the fixed charge will be levied after we have seen the product and identified the misuse. In this case we will request you to issue a purchase order or provide credit card details before any repairs are completed.

Our policy is to return the repair (or swap-out) to you within 10 days of receipt.

12.3 Disclaimer/Copyright Statement

© Datapath Ltd, England 2018

Datapath Limited claims copyright on this User Guide. No part of this User Guide may be reproduced, released, disclosed, stored in any electronic format, or used in whole or in part for any purpose other than stated herein without the express permission of Datapath Limited.

Whilst every effort is made to ensure that the information contained in this User Guide is correct, Datapath Limited make no representations or warranties with respect to the contents thereof, and do not accept liability for any errors or omissions.

Datapath reserves the right to change specification without prior notice and cannot assume responsibility for the use made of the information supplied. Datapath Limited acknowledges all registered trademarks used within this User Guide.

Chapter 13 - Index

A

Add Monitors 8
Allocating inputs 23
Auto-configure 8

B

Background Image 18

C

Cable Lengths 21
Cables 11
Cable Type 21
Certification 28
Class A Declaration of Conformity 28
Compliances 28
Configure Via a Network 6
Configuring the Hx4 via USB 23
Connecting an HDMI Input Cable 20
Connecting Outputs 22
Connecting to a PC 6
Contents 5
Control Interfaces 29
Control panel 9

D

Devices 19
DHCP 25
Dimensions 29
Display Screens Turn Red 26
Disposal 28

E

Ethernet Port 6

F

FCC Rules 28
Features 13
Firmware Support 29
Fonts and Symbols 10

G

Gateway 25
Genlock Input 29

H

HDMI Cable Lock 20
Help Files 19

I

Initial Inspection 11, 12
Inputs 14, 19
Input Surface 29
Install the Wall Designer Software 16
Introduction 10
IP address 25
IP Control Panel 9

L

LAN connector 6
LEDs 14

M

MAC OS X 13
Maintenance 11, 27
Manufacturer Warranty 30
Monitors 18
Mounting screws 15

N

Network Settings 25
Network Timing Out 26

O

Operating Temperature 29
Operation Indicators 14
Operation Modes 18
Overview 13

P

Power Requirements 29
power supply 11
Power Supply 11
Product End of Life 28

Q

Quick Start Guide 5
Quick Tour 18, 19

R

Rack Mounting the Hx4 15
Readme 16
Rear Panel 14
Relative Humidity 29
Returns Policy 30
RMA Number 30
RMA Returns 30

S

Safety 11
Static IP's 25
Status 8, 19
Storage Temperature 29
Subnet Mask 25
Switching On 22
Symbols 10
Sync 14

T

Toolbar 18, 19

U

Unpacking 11, 12

V

- Ventilation 11
- Ventilation holes 27
- Video Input Connections 29
- Video Output Connections 29
- Virtual Canvas 18, 19

W

- Wall Designer 16
- Wall Designer Features 16
- Wall Designer Interface 18
- Warranty 29
- Windows 13