

DIGITAL 
PROJECTION

A Delta Associate Company

M-Vision 23000 Series

High Brightness Digital Video Projector

INSTALLATION & QUICK START GUIDE

CONNECTION GUIDE

OPERATING GUIDE

REFERENCE GUIDE



About this document

Follow the instructions in this manual carefully to ensure safe and long-lasting use of the projector.

Symbols used in this document

Many pages in this document have a dedicated area for notes. The information in that area is accompanied by the following symbols:



LASER WARNING: this symbol indicates that there is a potential hazard of eye exposure to laser radiation unless the instructions are closely followed.



LIGHT HAZARD WARNING: this symbol indicates that there is a danger of exposure to intensive light that may result in personal injury unless the instructions are closely followed.



ELECTRICAL WARNING: this symbol indicates that there is a danger of electrical shock unless the instructions are closely followed.



WARNING: this symbol indicates that there is a danger of physical injury to yourself and/or damage to the equipment unless the instructions are closely followed.



NOTE: this symbol indicates that there is some important information that you should read.

Product revision

Because we at Digital Projection continually strive to improve our products, we may change specifications and designs, and add new features without prior notice.

Additional Documentation

Updates to this manual may be available online.

Please use the QR code (also located on the projector) to access the latest M-Vision projector user guides and other documentation via the Digital Projection website.



Or visit the products specification page on the Digital Projection website to download the latest user guide and other documentation.

Legal notice

Trademarks and trade names mentioned in this document remain the property of their respective owners. Digital Projection disclaims any proprietary interest in trademarks and trade names other than its own.

Copyright © 2020 Digital Projection Ltd. All rights reserved.

Notes

What's in the box?

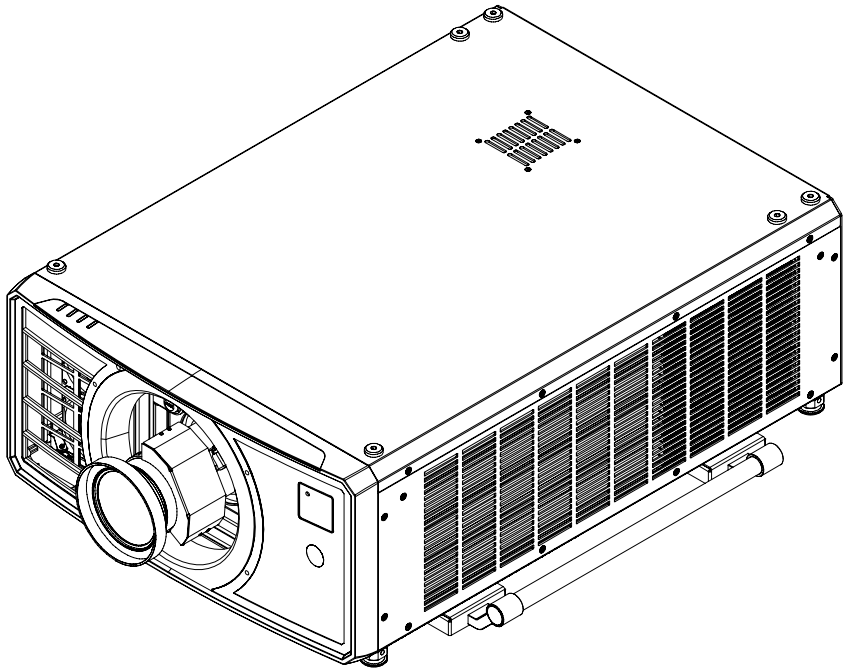

Projector

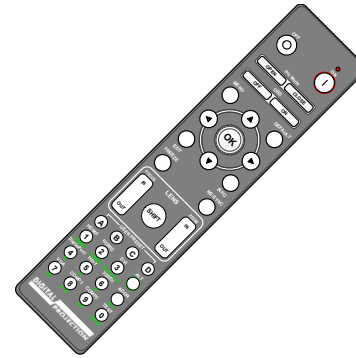

Remote Control

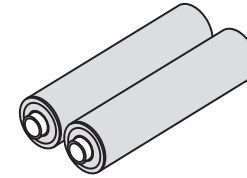

Batteries (2xAAA)

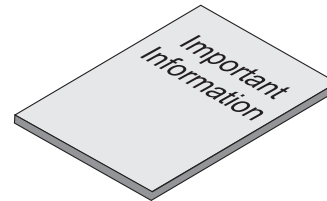

Important Information Book

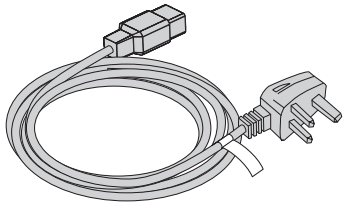

Power Cable, UK

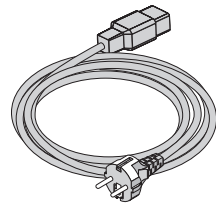

Power Cable, Europe

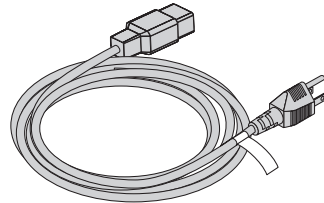

NEMA 5-15P - C19 Power Cable, North America

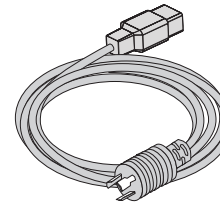

NEMA L6-20P - C19 Power Cable, North America

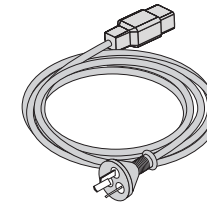

Power Cable, China

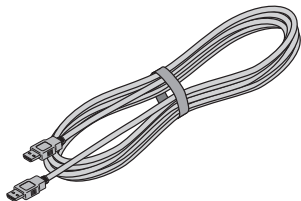



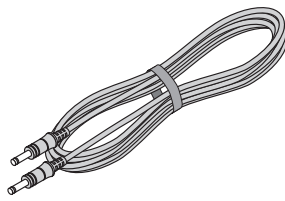

HDMI Cable



Remote Control Cable

Notes

-  *Make sure your box contains everything listed. If any pieces are missing, contact your dealer.*
-  *Only one remote is supplied with the projector.*
-  *Save and store the original box and packing materials, in case you ever need to ship your projector.*
-  *The projector is shipped without a lens.*
-  *Only the appropriate cable for destination territory is supplied with the projector*

Electrical and Physical Specifications

Mains Voltage	110-240 VAC 50/60Hz
Operating Temperature	0°C to 40°C (32 F to 104 F), 40°C to 45°C (104 F to 113 F) with reduced light output
Storage Temperature	-20°C to 60°C (-4 F to 140 F)
Operating Humidity	10% to 90% non-condensing
Storage Humidity	10% to 90% non-condensing
Dimensions	W 748 mm (29.4 in), H 248 mm (9.8 in), D 530 mm (20.9 in)
Weight	54 kg (119 lb) without lens
Power Consumption	at 100VAC: typical 1250 W in Normal mode at 100VAC: typical 1000 W in Eco mode at 200VAC: typical 1900 W in Normal mode at 200VAC: typical 1200 W in Eco mode
Standby Power	<0.5W in Saving mode, <6W in Normal mode
Thermal Dissipation	at 110 VAC: typical 4334 BTU/hr in Normal mode at 110 VAC: typical 3412 BTU/hr in ECO mode at 240 VAC: typical 4146 BTU/hr in Normal mode at 240 VAC: typical 3276 BTU/hr in ECO mode
Fan Noise	typical 48dB, max 50db in Normal mode typical 46dB, max 48dB in ECO mode

 Specifications are subject to change without notice.

Notes

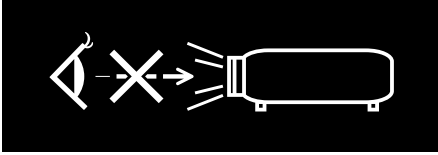
Optical radiation**CLASS 3R LASER PRODUCT**

This Laser Product is designated as Class 3R during all procedures of operation.

LASER LIGHT - AVOID DIRECT EYE EXPOSURE.

Caution - possibly hazardous optical radiation emitted from this product. Direct or scattered light can be hazardous to eyes and skin.

Do not stare at operating light source.

Do not point laser or allow laser light to be directed or reflected toward other people or reflective objects.

There is a potential hazard of eye exposure to laser radiation if the included instructions are not followed.



Caution – use of controls or adjustments or performance of procedures other than those specified herein may result in hazardous radiation exposure.

Non-laser emission. There remains non-laser emission from the projection lens.

This projector is tested according to IEC/EN62471-5:2015 (Photobiological safety of lamps and lamp systems – Part 5: Image projectors standard) and is Risk Group 3

Notes

Laser information

Notes

LASER RADIATION AVOID DIRECT EYE EXPOSURE CLASS 3R LASER PRODUCT Emitted Wavelength : 450-460 nm (Blue) max pulse energy : 0.45 mJ (Blue) Pulse duration : 0.87 ms (Blue)		激光辐射 避免眼睛受到直接照射 3R类激光产品 波长: 450-460 nm (蓝) 最大脉冲能量: 0.45 mJ (蓝) 脉冲时间: 0.87 ms (蓝)	
Emitted Wavelength : 636-640 nm (Red) max pulse energy : 0.77 mJ (Red) Pulse duration : 1.77 ms (Red)		3R类激光产品 波长: 636-640 nm (红) 最大脉冲能量: 0.77 mJ (红) 脉冲时间: 1.77 ms (红)	
RAYONNEMENT LASER EXPOSITION DIRECTE DANGEREUSE POUR LES YEUX APPAREIL À LASER DE CLASSE 3R longueur d'onde : 450-460 nm (Bleu) maximum énergie de impulsion : 0.45 mJ (Bleu) durée de impulsion : 0.87 ms (Bleu)		激光辐射 避免眼睛受到直接照射 3R类激光产品 波长: 450-460 nm (蓝) 最大脉冲能量: 0.45 mJ (蓝) 脉冲时间: 0.87 ms (蓝)	
longueur d'onde : 636-640 nm (Rouge) maximum énergie de impulsion : 0.77 mJ (Rouge) durée de impulsion : 1.77 ms (Rouge)		3R类激光产品 波长: 636-640 nm (红) 最大脉冲能量: 0.77 mJ (红) 脉冲时间: 1.77 ms (红)	
GB 7247.1-2012 / IEC/EN 60825-1:2007			
CLASS 1 LASER PRODUCT 一类激光产品 IEC/EN 60825-1:2014		PRODUIT LASER DE CLASSE 1 第一类雷射产品 IEC/EN 60825-1:2014	
Warning ! Do not look into the beam. No direct eye exposure to the beam is permitted. RG3 Hazard Distance : 0-650 cm		警告 ! 请勿直视镜头。 眼睛不要直接暴露于光辐射。 RG3 危险距离 : 0-650厘米	
Avertissement ! Ne Pas Regarder Directement Dans Le Faisceau. L'exposition Directe Des Yeux Au Faisceau Est Interdite. RG3 Distance À Risque : 0-650 cm		警告 ! 請勿直視鏡頭。 眼睛不要直接暴露於光輻射。 RG3 危險距離 : 0-650公分	



Caution - use of controls or adjustments or performance of procedures other than those specified herein may result in hazardous radiation exposure.



Not for home use.

Location of Laser Aperture

1. The laser aperture is located as indicated below.



Be careful not to expose the eye to direct laser light.

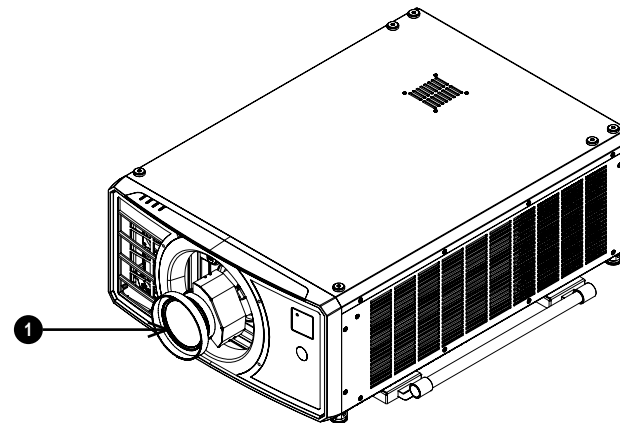

Laser Parameters

Wavelength (Red)	635-647nm
Wavelength (Blue)	450-460nm
Mode of operation	Pulsed, due to frame rate
Pulse duration (Red)	1.77ms
Pulse duration (Blue)	0.87ms
Pulse repetition rate	180Hz
Maximum pulse energy (Red)	0.77mJ
Maximum pulse energy (Blue)	0.45mJ
Total internal power	<100W

Notes

Risk Group 3 Laser Hazard Installation Precautions



This product is a risk group 3 laser product. It must be installed in a safe place and must be handled by qualified and professionally trained personnel.

Do not attempt to access the internal hardware of the projector. Do not attempt to modify or remove the laser module.

Do not operate the projector without its protective covers.

Do not operate the projector without a lens installed.

Please consult with a qualified professional to install or remove the lens.

FDA regulations require that a lens hood is permanently fitted when using the 4.0-7.0:1 lens with the projector in the United States of America. Fitting can be provided by your reseller or System Integrator.

Light Hazard Warning



No direct exposure to the beam is permitted, RG3 IEC 62471-5:2015.

Operators should control access to the beam within the hazard distance or install the projector at sufficient height to prevent exposures of spectators' eyes within the hazard area. When the laser is installed overhead, allow a minimum of 3m between the floor surface and the Risk Group 3 area.

Light Hazard Distance and Hazard Zone

The hazard distance is the distance measured from the projection lens at which the intensity or energy per unit of surface is lower than the applicable exposure limit on the cornea or skin. ①

The hazard zone is the area from the projection lens up to the hazard distance that encompasses where the projected beam is considered hazardous. ②

If the person is within the hazard zone, the beam is considered unsafe for exposure.

The hazard distance for this projector is 4m.

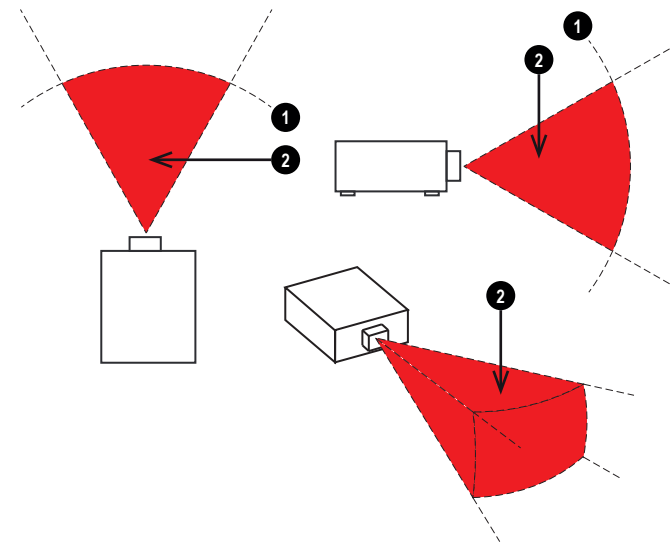

Notes



Operators should control access to the beam within the hazard distance or install the projector at sufficient height to prevent exposures of spectators' eyes within the hazard area.



When the laser is installed overhead, allow a minimum of 3m between the floor surface and the Light Hazard Zone.

Product Labels

Projector

Notes

DIGITAL PROJECTION

DLP PROJECTOR / DLP Projecteur (數位投影机 / 数字投影机)

Model / Modèle(型號 / 型号) : M-Vision 23000 WU

AC Input / Entrée CA(輸入 / 輸入) : 200-240V ~ 50/60Hz 10.6A

AC Input / Entrée CA(輸入 / 輸入) : 110-130V ~ 50/60Hz 11.1A

Caution: Do not open the cover. No user-serviceable parts inside.
Avertissement: ne pas ouvrir le couvercle. Le produit ne contient aucune pièce interne réparabile par l'utilisateur.

警告: 請勿打開外殼, 殼體內無服務性維修之元件。
警告: 請勿打開外殼, 殼體內無服務性維修之元件。

This device complies with part 15 of the FCC rules.
Operation is subject to the following two conditions:
(1) this device may not cause harmful interference, and
(2) this device must accept any interference received, including interference that may cause undesired operation.

此設備符合 FCC 規則第 15 部分。
操作須符合下列兩個條件:
(1) 此設備不得造成有害干擾, 且
(2) 此設備必須接受其所收到之任何干擾, 包括可能導致不期望操作之干擾。

제품명: 프로젝터
인증번호: 한국-DVP-MV23000WU
2019002-20096
상호명/제조자: 델타일렉트로닉스(주)
제조국가: YYYKMMDD
제조공장/제조국가: 델타 일렉트로닉스 (중국) 허미티드
A/S 센터: +82 2 515 5303
모델명: M-Vision 23000 WU
제조국: 중국 / 제조국명: Made in China

UK LISTED CE RoHS

Part No.: 121-083A

Code 3R or 3R (Solid No.)
XXXXXXXXXXXXX
MANUFACTURED YYYY.MM.DD

(For EU Importer)
Delta Electronics (Netherlands) B.V.
Zuidhaven 15, 2112 MC Rotterdam,
The Netherlands

制造商: Digital Projection Limited
Greenway Way Middleton Manchester: M24 1XX UK

Manufacturers ID Label

Complies with FDA performance standards for laser products except for deviations pursuant to Laser Notice No. 50, dated June 24, 2007

CLASS 1 LASER PRODUCT
一类激光产品
IEC/EN 60825-1:2014
IEC/EN 62471-5:2015

PRODUT LASER DE CLASSE 1
第一類雷射產品
IEC/EN 60825-1:2014
IEC/EN 62471-5:2015

Warning! Do not look into the beam. No direct eye exposure to the beam is permitted.
RG3
Hazard Distance : 0-400cm

Avertissement ! Ne Pas Regarder Directement Dans Le Faisceau. L'exposition Directe Des Yeux Au Faisceau Est Interdite.
RG3
Distance À Risque : 0-400cm

警告! 請勿直視鏡頭。眼睛不要直接暴露於光輻射。
RG3
危險距離: 0-400公份

LASER RADIATION
激光輻射
避免眼睛受到直接照射

AVOID DIRECT EYE EXPOSURE
CLASS 3R LASER PRODUCT
Emitted Wavelength: 450-460 nm (Blue)
max pulse energy : 0.45 mJ (Blue)
Pulse duration : 0.87 ms (Blue)

3R类激光产品 波长: 450-460 nm (蓝)
最大脉冲能量: 0.45 mJ (蓝)
脉冲时间: 0.87 ms (蓝)

Emitted Wavelength: 635-647 nm (Red)
max pulse energy : 0.77 mJ (Red)
Pulse duration : 1.77 ms (Red)

3R类激光产品 波长: 635-647 nm (红)
最大脉冲能量: 0.77 mJ (红)
脉冲时间: 1.77 ms (红)

RAYONNEMENT LASER
EXPOSITION DIRECTE DANGEREUSE
POUR LES YEUX
APPAREIL À LASER DE CLASSE 3R
longueur d'onde : 450-460 nm (Bleu)
maximum énergie de impulsion : 0.45 mJ (Bleu)
durée de impulsion : 0.87 ms (Bleu)

雷射輻射
避免眼睛受到直接照射

3R類雷射產品 波長: 450-460 nm (藍)
最大脈衝能量: 0.45 mJ (藍)
脈衝時間: 0.87 ms (藍)

3R類雷射產品 波長: 635-647 nm (紅)
最大脈衝能量: 0.77 mJ (紅)
脈衝時間: 1.77 ms (紅)

longueur d'onde : 635-647 nm (Rouge)
maximum énergie de impulsion : 0.77 mJ (Rouge)
durée de impulsion : 1.77 ms (Rouge)

GB 7247.1-2012 / IEC 60825-1:2007

Explanatory Label

LASER APERTURE
雷射輻射之孔徑
激光辐射窗口
OUVERTURE LASER

Laser Aperture Label

M-Vision User Guides

Follow link for Projector Documentation
Suivre le lien pour accéder à la documentation du projecteur
Produktdokumentation finden Sie unter dem Link
この二次元バーコードをスキャンしてプロジェクターのデータを取得してください
请扫描条码来取得投影机的文件
프로젝터 설명서를 보려면 링크를 팔로우하십시오

User Guides Label

Label Locations

1. Location of Hazard Warning Symbol and Laser Aperture Label on the body of the projector.
2. Location of Manufacturer's ID Label, User Guides Label and Explanatory Label with Certification Statement and Risk Statement on the body of the projector.

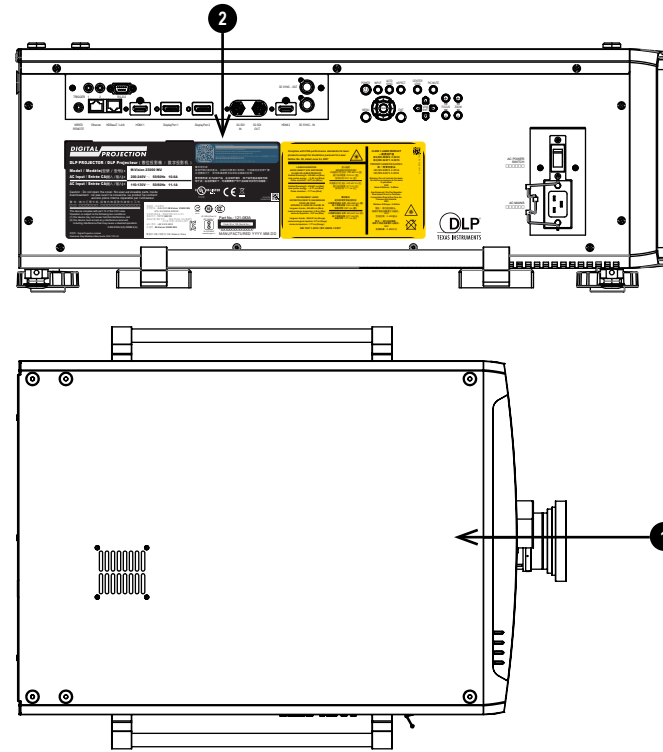

Notes

Interlock Switches

Interlock switches are installed at the main frame, inside the cover. These will power-off the system individually when activated.

1. Will be activated when the projection lens is removed or misplaced.
2. Will be activated when the top cover is removed.

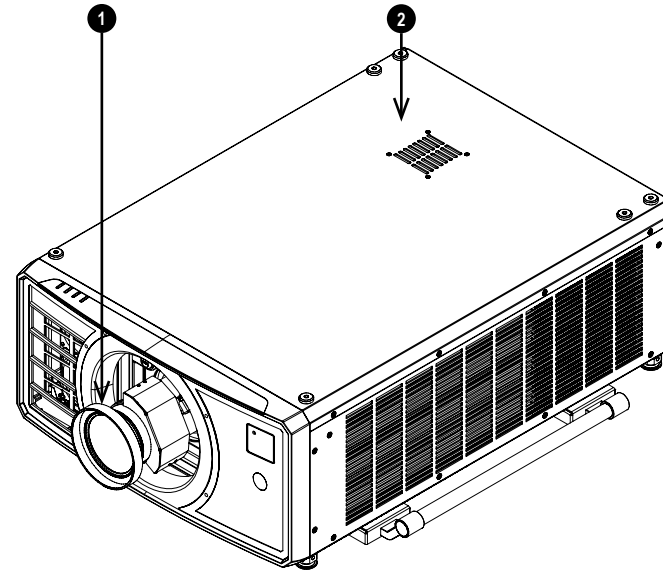

Notes

Introduction

Notes

Congratulations on your purchase of this Digital Projection product. Your projector has the following key features:

- WUXGA native resolution delivering 23,000 ISO lumens.
- Support for Frame Sequential 3D.
- Support for Dual Pipe 3D format.
- HDBaseT® for transmission of uncompressed High Definition Video up to 100 m from the source.
- 3G-SDI with loop-through.
- Edge Blend with black level correction.
- Red laser assist for enhanced color fidelity.
- Blanking control for custom input window sizing.
- Cornerstone, Vertical & Horizontal Keystone, Pincushion & Barrel, and Image Rotation.
- Control via LAN and RS232.
- Motorised lens mount.
- Separate control of screen and source aspect ratio.
- Non-linear warp for irregular projection surfaces.
- Constant brightness mode maintains light output at selected levels.

A serial number is located on the side of the projector. Please record it here for future reference:

Contents

Notes

About this document 2

Symbols used in this document 2

Product revision 2

Additional Documentation 2

Legal notice 2

What's in the box? 3

Electrical and Physical Specifications 4

Optical radiation 5

Laser information 6

Location of Laser Aperture 6

Laser Parameters 7

Risk Group 3 Laser Hazard Installation Precautions 8

Light Hazard Warning 8

Light Hazard Distance and Hazard Zone 8

Product Labels 9

Projector 9

Label Locations 10

Interlock Switches 11

Introduction 12

Contents 13

Projector overview 18

Control panel 19

Remote control 20

Infrared reception 24

Positioning the screen and projector 25

Roll and pitch 26

Changing the lens 27

Inserting a new lens 27

Removing the lens 28

Fitting a lens hood 29

Stacking 30

Pin and cup stacking 30

Connecting the power supply 33

Operating the projector 34

Switching the projector on 34

Switching the projector off 34

Selecting an input signal 34

Selecting a test pattern 34

Adjusting the lens 35

Adjusting the image 35

Orientation 35

Geometry 35

Picture 35

Signal inputs 38

Digital inputs and outputs 38

EDID on the DisplayPort, HDMI, and HDBaseT inputs 39

Using DisplayPort / HDMI / HDBaseT switchers with the projector 39

3D connections 40

Dual Pipe 1080p, WUXGA and WQXGA+ 3D sources at up to 100 and 120Hz 40

3D Sync 41

Control connections 42

LAN connection examples 43

RS232 connection example 44

Using the menus 46

Opening the Menu 46

Opening a submenu 46

Exiting menus and closing the OSD 47

Inside a menu 47

Accessing sub menus 48

Executing commands 48

Editing projector settings 49

Using a slider to set a value 49

Editing numeric values 50

Using the projector 51

Main Menu 51

Lens menu 52

Lens control 52

Lens memory 53

Image 54

Color 55

 Color Space 55

 Color Mode 56

 ColorMax 56

 Manual Color Matching 57

 Color matching parameters explained 58

 Color Temperature 59

 Gains and Lifts 59

 3 Color Matching 60

 7 Color Matching 61

Geometry 62

 Aspect Ratio 62

 Theaterscope setting 63

 Digital Zoom 64

 Overscan 65

 Blanking 66

 Keystone 67

 Top right corner example 71

 Rotation 72

 Rotation example 73

 Pincushion / Barrel 74

 Pincushion/ Barrel example 74

 Arc 75

 Custom Warp 76

 Warping Grids 77

 Custom Masking 77

 Warp Filter 77

Edge Blend 78

 Blend Start 79

 Blend Width 80

 Black Level Uplift 81

3D 82

 3D types 83

 Some 3D settings explained 84

 Dark Time 84

 Eye Swap 84

 Sync Offset 85

Laser 86

Setup 87

 ColorMax 89

 Measured data/ target data 89

 Power on/off 90

 Clock Adjust 91

 OSD Settings 91

 Memory 92

 EDID Mode 92

Network 93

PIP 94

Information 95

 Signal Format 95

 System Status 96

 Thermal Status 96

 Factory Reset 97

Served web pages 98

Choosing a lens 100

 Basic calculation 101

 Basic calculation example 102

 Full lens calculation 103

 Introducing TRC 103

 Calculating TRC 104

 TRC table 104

 Calculating the throw ratio with TRC 104

 Full lens calculation example 105

Screen requirements 106

 Fitting the image to the display 106

 WUXGA images displayed full width 106

 WUXGA images displayed with a height of 2160 pixels 106

 WUXGA images displayed full height 107

 Diagonal screen sizes 107

Positioning the image 108

Aspect ratios explained 110

 Aspect ratios examples 110

 Source: 4:3 110

 Source: 16:9 111

 Source: 16:10 (native) 111

 Aspect ratio example: TheatreScope 112

Notes

Appendix A: supported signal input modes 113
 2D formats113
 3D formats115

Appendix B: wiring details 117
 Signal inputs and outputs117
 HDMI 117
 DisplayPort118
 3G-SDI in, 3G-SDI out119
 HDBaseT input119
 Control connections119
 LAN119
 RS232 120
 Trigger 120

Appendix C: glossary of terms 121

Notes

This page is intentionally left blank

DIGITAL 
PROJECTION

A Delta Associate Company

M-Vision 23000 Series

High Brightness Digital Video Projector

INSTALLATION & QUICK START GUIDE



Projector overview

1. Connections panel
2. Control panel
3. Indicators
4. Lens mount
5. Front infrared window
6. Lifting handles
7. Mains socket and switch
8. Air inlet

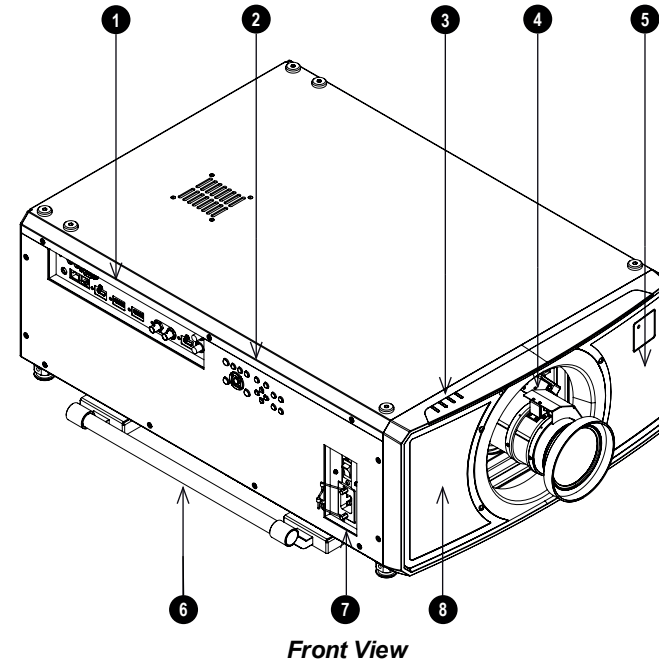
**Notes**

Control panel

1. **POWER**
Switches the projector on and off (STANDBY).
2. **INPUT**
Switches to the next input source.
3. **AUTO SYNC**
Re-synchronises with the current input signal.
4. **ASPECT**
Changes the aspect ratio.
5. **CENTER LENS**
Centers the lens.
6. **PIC MUTE** Shows and hides the projected image.
When muted, the light source is completely switched off and the screen is black.
7. **MENU**
Displays and exits the OSD.
8. **Arrow buttons & ENTER**
Navigation buttons used to highlight menu entries in the OSD. Press **ENTER** to open or execute the highlighted menu entry.
9. **EXIT**
Exits the current OSD page and enters the level above.
10. **LENS SHIFT**
Arrow buttons move the lens in the specified direction.
11. **FOCUS**
Plus and minus buttons move the focus in and out.
12. **ZOOM**
Plus and minus buttons zoom in and out.

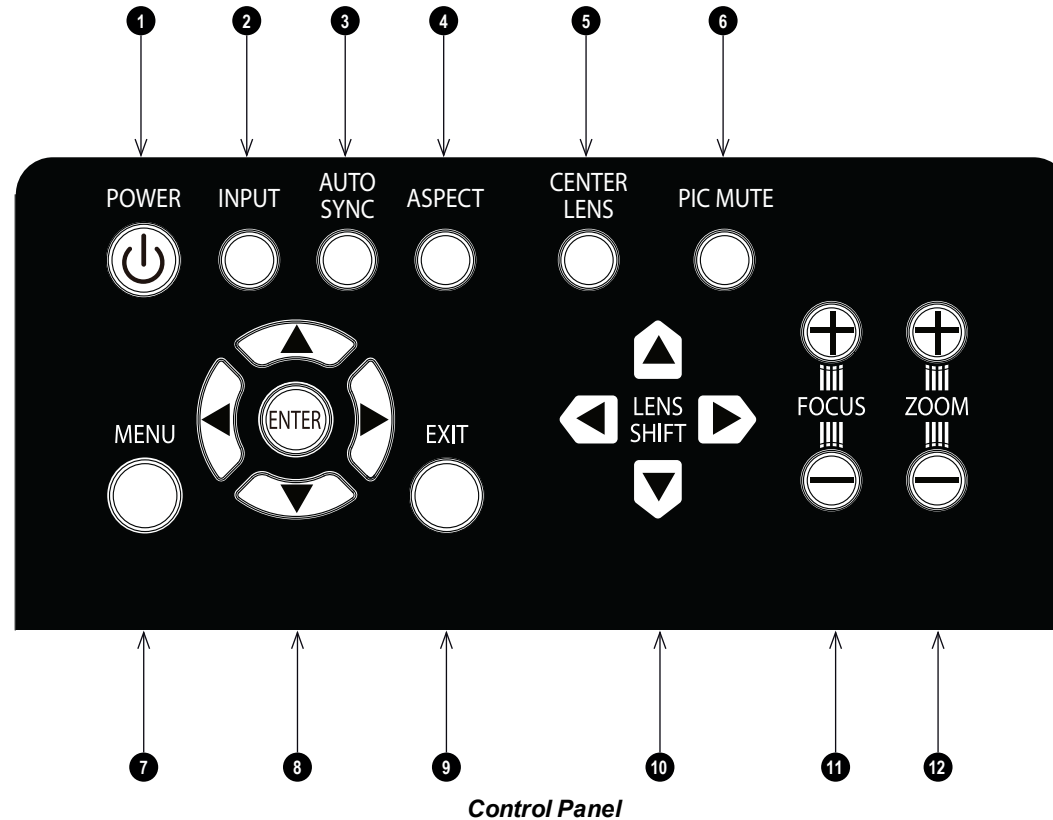

Notes

Remote control

- Power ON / OFF**
Turns power on and off.
- Pic Mute OPEN / CLOSE**
Shows and hides the projected image.
There are two PIC Mute settings:
 - Laser. When off, the laser is switched off and no image is projected
 - DMD Blanking. When off, the laser remains on and a black image is projected
- OSD ON / OFF**
Enable and disable screen timeout messages and control whether to show the OSD during projection.
- MENU**
Access the on screen display (OSD). If the OSD is open, press this button to go back to the previous menu.
- Navigation (arrows and OK)**
Navigate through the menus with the arrows, confirm your choice with **OK**.
In lens adjustment modes, the arrows are used to shift, zoom or focus the lens.
See **11** below. In lens adjustment modes, or when the OSD is not showing, the OK button switches between modes: **Shift Adjustment** and **Zoom / Focus Adjustment**.
- EXIT**
Go up one level in the OSD. When the top level is reached, press to close the OSD.
- DEFAULT**
When editing a parameter, press this button to restore the default value.
- INFO**
Access information about the projector.

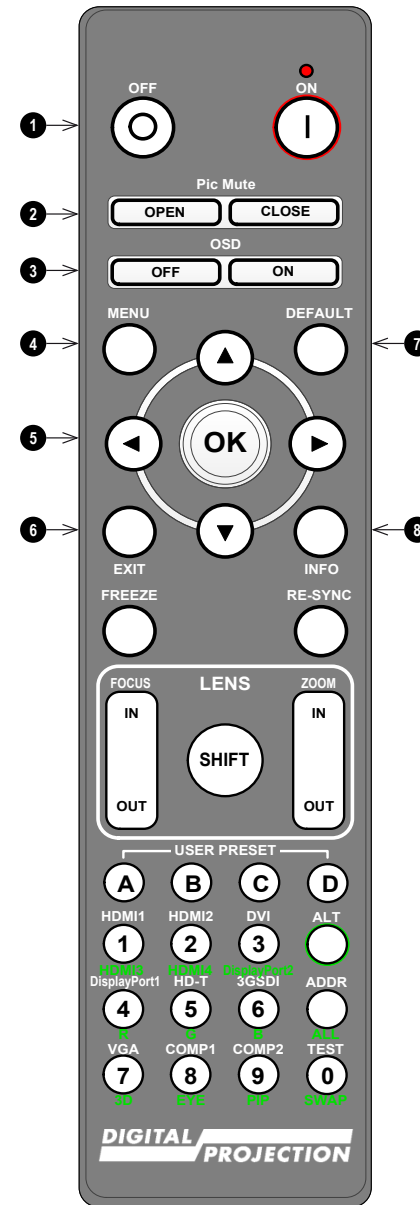

Remote Control

Notes

 The PIC Mute setting is defined in the setup menu. See Setup on page 87

9. **FREEZE**
Freeze the current frame.
10. **LENS adjustment**
 - **FOCUS IN / OUT:** adjust focus.
 - **SHIFT:** press and hold this button, then use the Navigation arrow buttons to move the lens.
 - **ZOOM IN / OUT:** adjust zoom.
11. **USER PRESET A, B, C, D**
Load user presets.
12. **RE-SYNC**
Re-synchronise with the current input signal
13. **ALT**
Press and hold this button to access alternative functions for all buttons with a green label.
14. **DVI / DisplayPort2 / numeric input 3**
There is no DVI input on this projector.
Use with **ALT** to select the DisplayPort 2 input.
15. **HDMI 2 / HDMI 4 / numeric input 2**
Select the HDMI 2 input.
There is no HDMI 4 input on this projector
16. **HDMI 1 / HDMI 3 / numeric input 1**
Select the HDMI 1 input.
There is no HDMI input on this projector

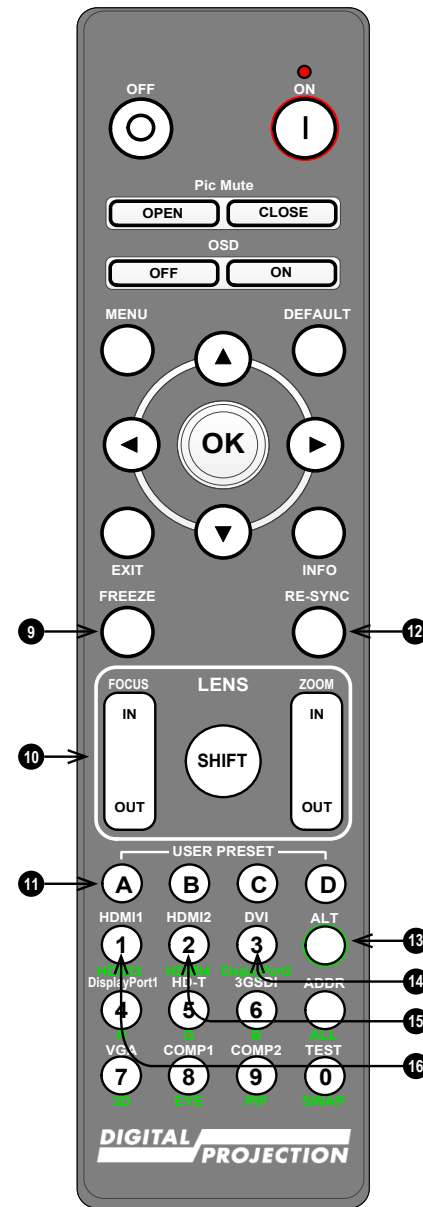

Notes

 This projector does not use the following options on the remote: DVI

17. DISPLAYPORT 1 / R / numeric input 4

Select DisplayPort 1 input.

18. HD-T / G / numeric input 5

Select the HDBaseT input.

19. ADDR / ALL (with red indicator at the top)

Assign and unassign an IR remote address.

To assign an IR remote address:

1. Press and hold this button until the red indicator starts flashing.
2. Release this button and while the red indicator is still flashing, enter a two-digit address using the numeric input buttons. The indicator will flash three times quickly to confirm the change.

To unassign an address and return to the default address 00:

1. Press and hold ALT and this button simultaneously until the red indicator flashes to confirm the change.

20. 3GSDI / B / numeric input 6

Select the 3G-SDI input.

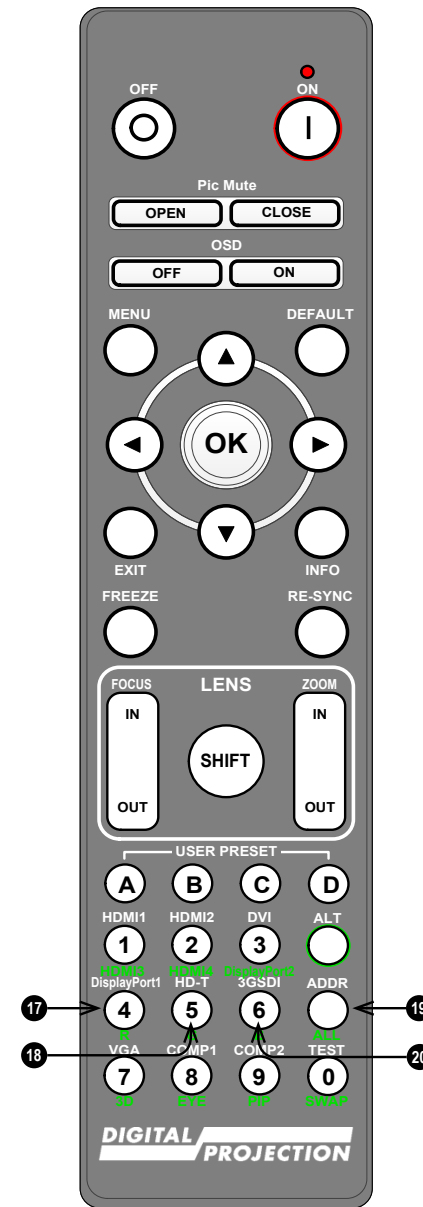

Remote Control

Notes

21. **VGA / 3D / numeric input 7**
Select the VGA input. There is no VGA input on this projector.
Use with **ALT** to toggle the 3D Format setting between Off and Auto.
22. **COMP1 / EYE / numeric input 8**
There is no Component 1 input on this projector.
Use with **ALT** to switch between left and right eye 3D dominance.
23. **TEST / SWAP / numeric input 0**
Show a test pattern. Press again to show the next test pattern: *White, Black, Red, Green, Blue, Checkerboard, Crosshatch, V Burst, H Burst, Color Bar, Pluge, Off.*
When **PIP** mode is on, use this button with **ALT** to swap the main and sub images.
24. **COMP2 / PIP / numeric input 9**
There is no Component 2 input on this projector.
Use with **ALT** to switch on **Picture In Picture (PIP)** mode.

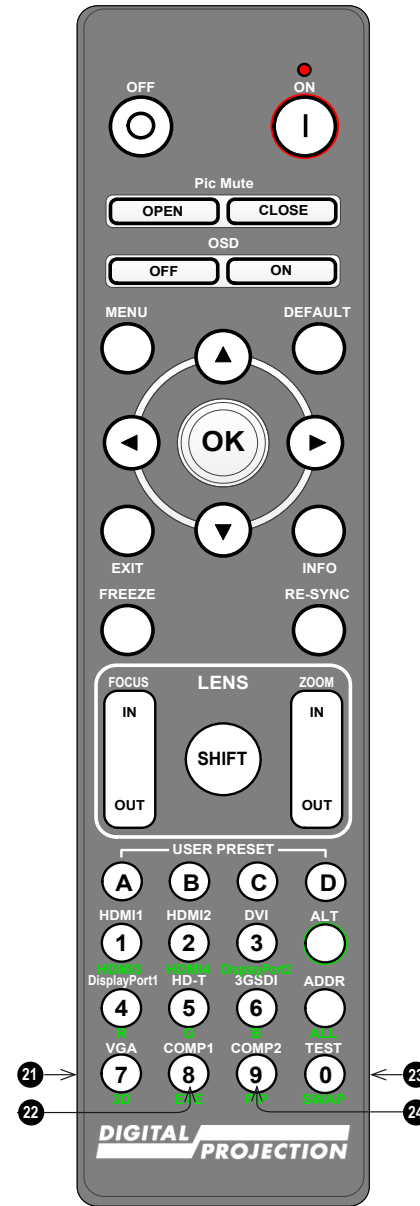

Remote Control

Notes

 This projector does not use the following options on the remote:
VGA
COMP 1
COMP 2

Infrared reception

The projector has infrared sensors at the front and rear.

The angle of acceptance is 40° . Make sure that the remote control is within the angle of acceptance when trying to control the projector.

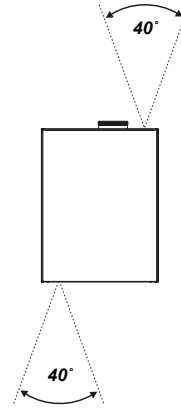

Notes

Positioning the screen and projector

1. Install the screen, ensuring that it is in the best position for viewing by your audience.
2. Mount the projector, ensuring that it is at a suitable distance from the screen for the image to fill the screen. Set the adjustable feet so that the projector is level, and perpendicular to the screen.

The drawing shows the positions of the feet for table mounting, and the fixing holes for ceiling mounting.

1. Four adjustable feet **1**.
2. **Six M6 holes for ceiling mount** **2**. The screws should not penetrate more than 15 mm into the body of the projector.

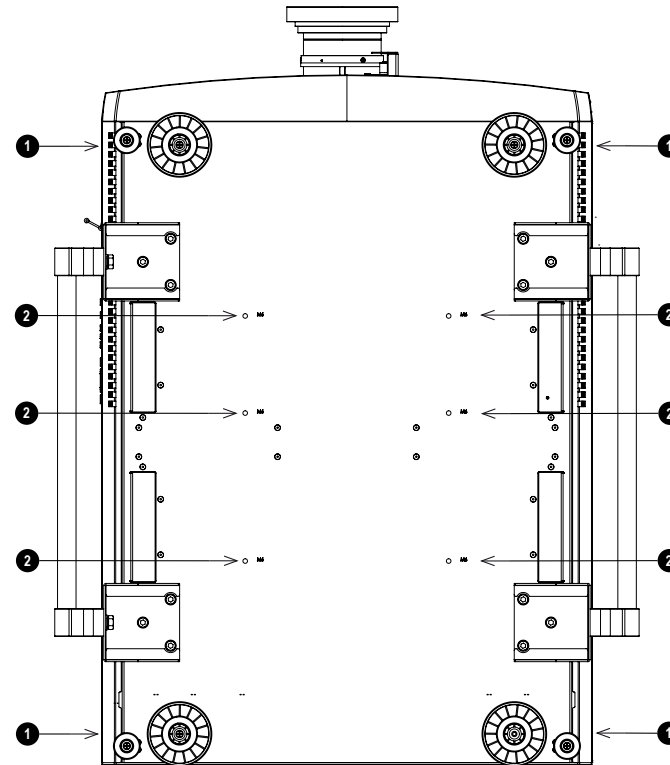

Notes



Always allow the projector to cool for 5 minutes before disconnecting the power or moving the projector.



Ensure that there is at least 50 cm (19.7 in) of space between the ventilation outlets and any wall, and 30 cm (11.8 in) on all other sides.



Do not use the threaded holes for the adjustable feet to hang or mount the projector.

Roll and pitch

The projector can be operated in numerous positions.

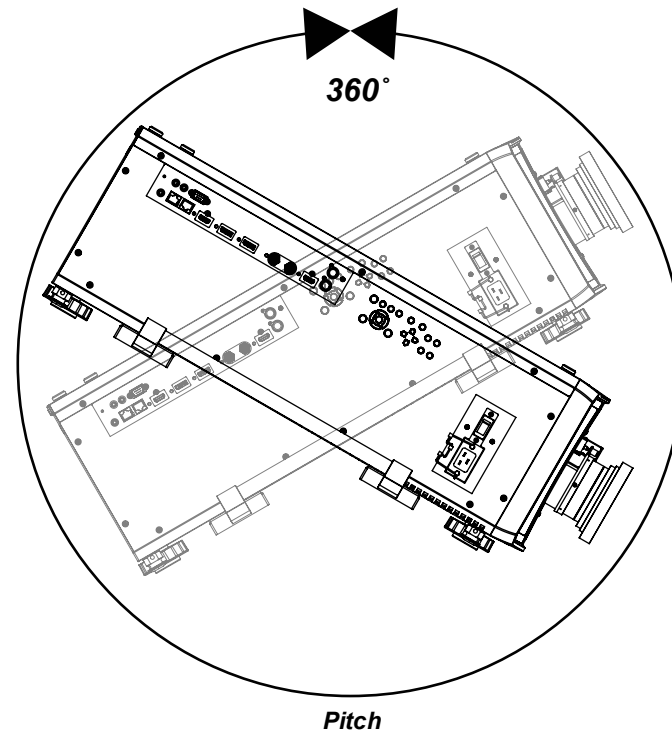
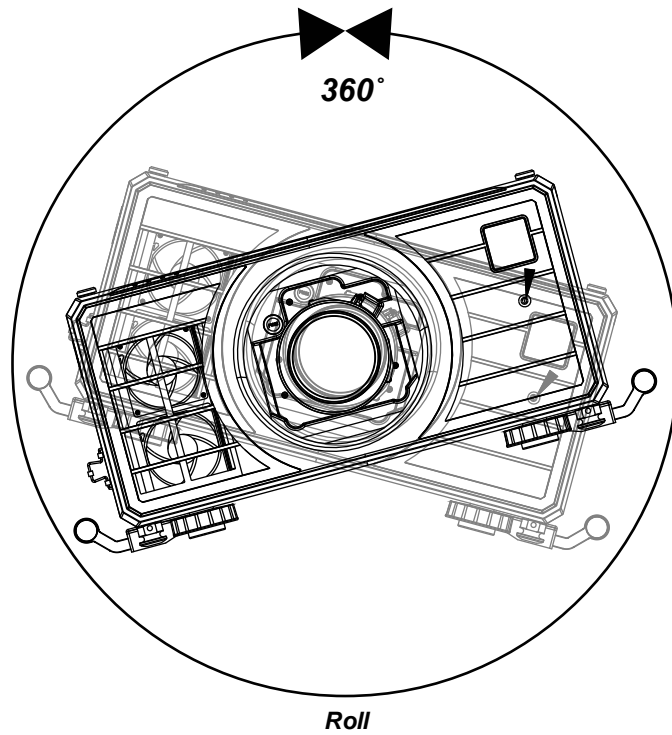

Notes

 Positioning the projector with the lens facing down or the inputs facing up may reduce motor life.

Changing the lens

Inserting a new lens

1. Remove the front and rear lens caps

2. Insert the lens with the connector in upright position.

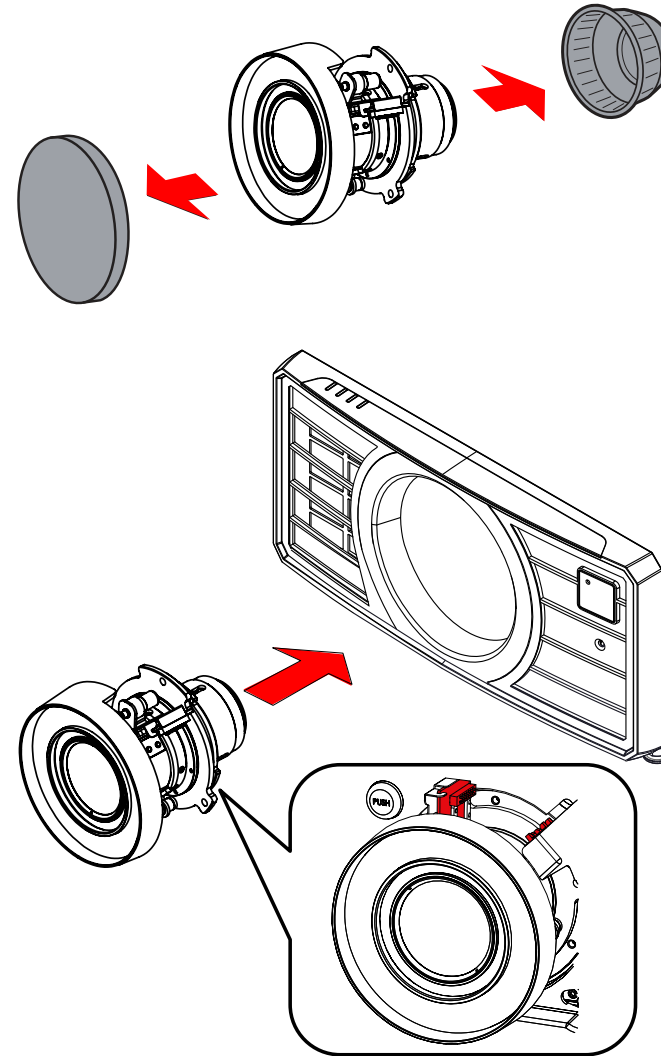



Notes

 The projector must be fully turned off prior to attempting a lens change.

 When changing the lens, avoid using excessive force as this may damage the equipment.

 Avoid touching the surface of the lens as this may result in image impairment.

 FDA regulations requires that a lens hood is permanently fitted when using the 4.00 - 7.00 : 1 zoom lens with the M-Vision Laser range of projectors in the United States of America. Fitting can be provided by your reseller or System Integrator.

 The lens is shipped separately.

 Take care to preserve the original lens packaging and protective caps for future use.

 The projector will not power on without the lens fitted.

3. Rotate the lens clockwise until it clicks into place.

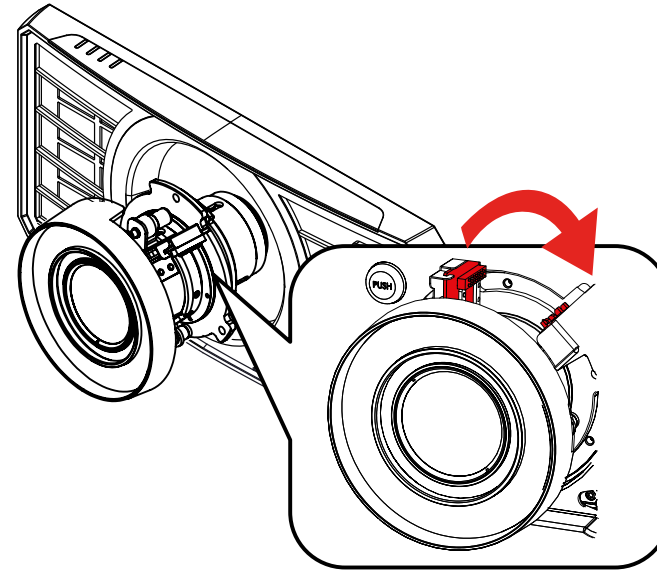

Notes

Removing the lens

1. Push the lens release button all the way in
2. Turn the lens anti-clockwise until it disengages
3. Slowly remove the lens.

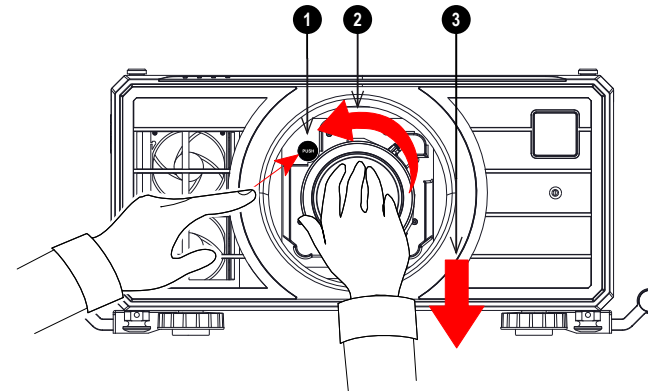

Fitting a lens hood

A lens hood can be fitted to the lens before the lens is inserted.

1. Push-fit the lens hood onto the lens. **1**

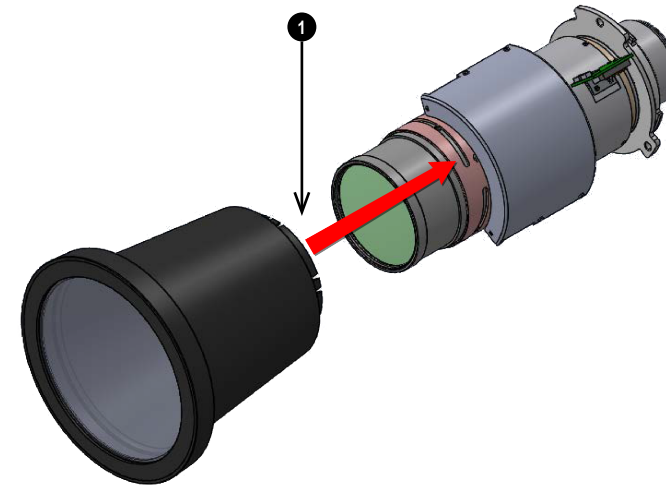

2. Fit the lens hood extension to the lens hood. **2**

3. Screw in five screws to secure the lens hood extension to the lens hood. **3**

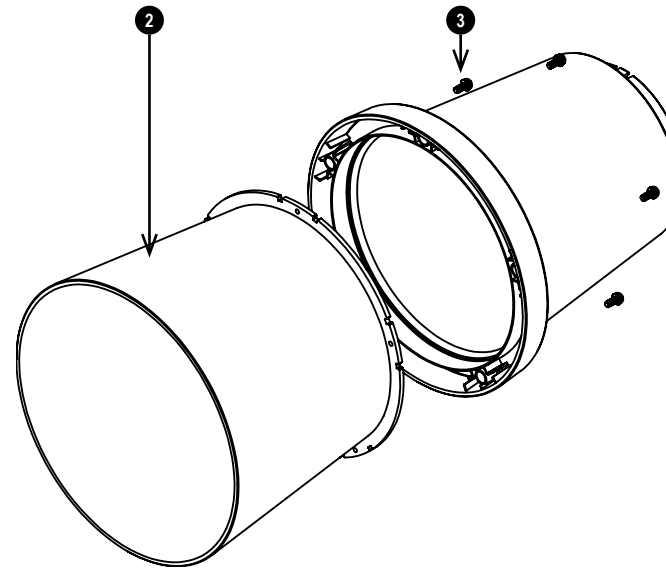

Notes





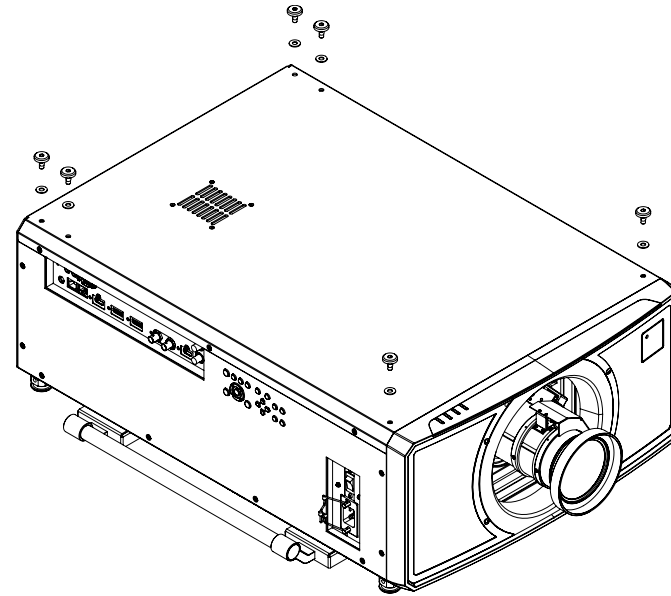

Stacking

Pin and cup stacking

1. Remove the six screws on the top side of the projector that will be on the bottom of the stack.



Notes

-  The projectors must be in a vertical position when they are stacked. This will ensure that the stresses are distributed to all four corners of the chassis.
-  Do not use the threaded holes for the adjustable feet to hang or mount the projector.
-  Do not use the carry handles to hang or mount the projector.
-  Do not stack more than two projectors.
-  Do not use the provided eye bolts to suspend stacked projectors. The eye bolts can only carry the weight of one projector.
-  Use only the provided screws with a torque of 25-30 kgf cm (2.45 - 2.94 Nm).
-  It is the customer's responsibility to ensure that the assembly is carried out securely.

2. Insert and secure the stacking tops in place of the removed screws.

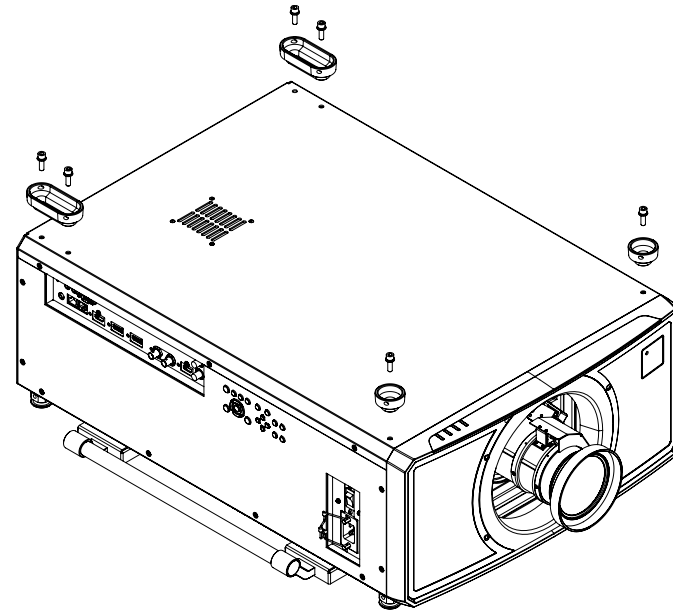

Notes

3. Remove the adjustable feet from the projector that will be stacked on the top.
4. Mount the projector on top of the other projector. Ensure that all four cups are placed over the pins on the bottom projector.

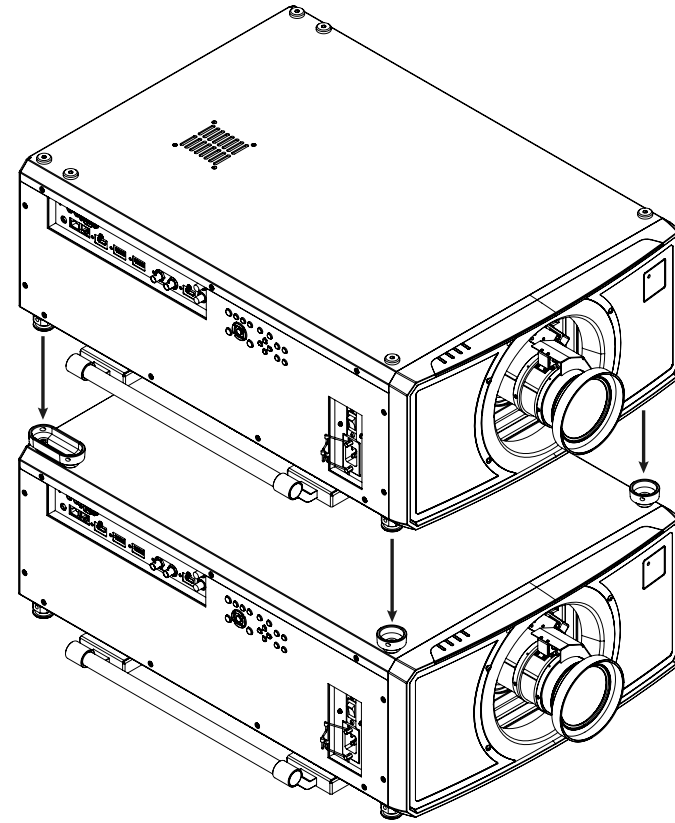

5. Use the provided holding pins to secure each connection.

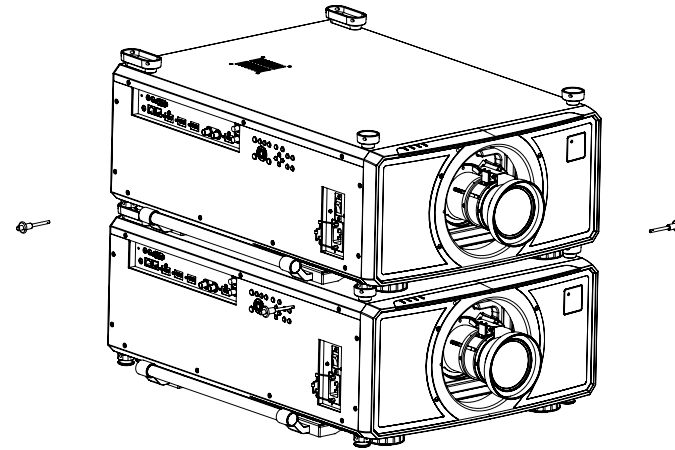

Notes

Connecting the power supply

1. Lift the cable lock up
2. Firmly push the mains connector into the AC In socket ①
3. Push the lock down to secure the cable

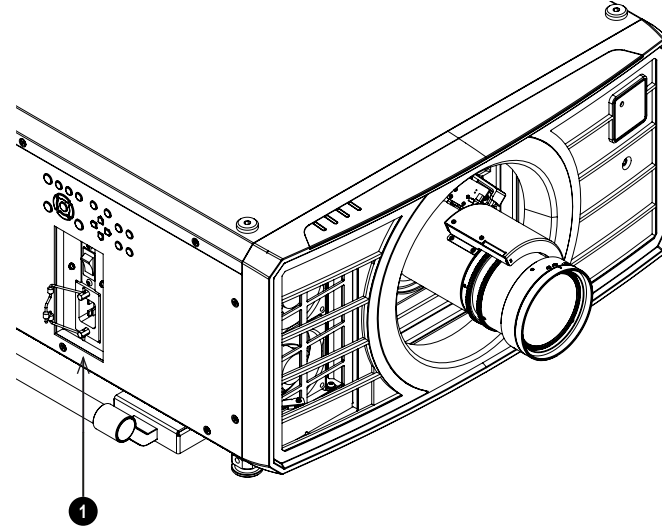

Notes



Use only the power cable provided.



Ensure that the power outlet includes a ground connection as this equipment **MUST** be earthed.



Handle the power cable carefully and avoid sharp bends. Do not use a damaged power cable.



Light output power is reduced by approx 35% when operating on 110V.

Operating the projector

Switching the projector on

1. Ensure a lens is fitted. Connect the power cable between the mains supply and the projector.
2. Switch on at the switch next to the power connector.
The **POWER** indicator lights red to signal that the projector is in STANDBY mode.
3. Press one of the following buttons:
 - On the remote control, the **ON** button
 - On the projector control panel, the **POWER** button.

The **POWER** indicator begins flashing green and the fans start working. The flashing stops and the **POWER** and **LIGHT** indicators both light steady green. The projector is now switched on.

Switching the projector off

1. Press **OFF** on the remote control or **POWER** on the control panel, then press again to confirm your choice.
The **POWER** indicator on the control panel will start flashing amber, the system will go out and the cooling fans will run for a short time until the **POWER** indicator goes steady red to indicate that the projector has entered STANDBY mode.
2. If you need to switch the projector off completely, switch off at the mains power switch next to the power connector and then disconnect the power cable from the projector.

Selecting an input signal

1. Connect one or more image sources to the projector.
2. Select the input you want to display:
 - Press one of the input buttons on the remote control.
 - Alternatively, open the On-screen display (OSD) by pressing **MENU**. Highlight **Input** from the main menu, press **ENTER/OK** and then select an input signal using the **UP** and **DOWN** arrow buttons. Press **ENTER/OK** to confirm your choice.

Selecting a test pattern

The following test patterns are available: *White, Black, Red, Green, Blue, Checkerboard, Crosshatch, V Burst, H Burst, Color Bar, Pluge, Off.*

To display a test pattern:

- Press **TEST** on the remote control.
Change the test pattern using the **LEFT** and **RIGHT** arrow buttons.
- Alternatively, open the OSD by pressing **MENU**. Highlight **Test Patterns** from the main menu, then select a test pattern using the **LEFT** and **RIGHT** arrow buttons.

After the final test pattern, the projector exits test pattern mode and returns to the main image. To view test patterns again, you need to press **TEST** again. If you wish to exit the test patterns before you reach the final one, press **TEST** or **EXIT** at any time.

Notes



See *Connecting the power supply* on the previous page.



The self-test is running when all the LEDs on the control panel are lit.



Use only the power cable provided.



Ensure that the power outlet includes a ground connection as this equipment **MUST** be earthed.



Handle the power cable carefully and avoid sharp bends. Do not use a damaged power cable.



See *Using the menus on page 46* for full details of how to use the controls and the menu system.

Adjusting the lens

You can use the following options to adjust the lens:

- Control panel. See Control panel on page 19
- Remote control. See Remote control on page 20
- On screen display (OSD). See Lens menu on page 52

Adjusting the image

Orientation

This can be set from the **Setup** menu.

Highlight **Orientation** and choose from **Front Tabletop**, **Front Ceiling**, **Rear Tabletop**, **Rear Ceiling** and **Auto-front**.

Geometry

Settings such as **Keystone**, **Rotation**, **Pincushion / Barrel** and **Arc** can be set from the **Geometry** menu.

Picture

Settings such as **Gamma**, **Brightness**, **Contrast**, **Saturation**, **Hue** and **Sharpness** can be set from the **Image** menu.

Notes

This page is intentionally left blank

DIGITAL  **PROJECTION**

A Delta Associate Company

M-Vision 23000 Series

High Brightness Digital Video Projector

CONNECTION GUIDE



Signal inputs

Digital inputs and outputs

1. **HDBaseT**

Receives digital signal from HDBaseT-compliant devices. Connect an HDBaseT cable.

2. **HDMI 1**

HDMI 1.4b input supporting **Frame Sequential** and **Dual Pipe** 3D with HDCP 1.4. Also supports the domestic Blu-Ray formats. See supported signal input modes on page 113. Connect an **HDMI** cable to the connector.

3. **DisplayPort 1**

DisplayPort 1.1a input. Connect a DisplayPort cable to the connector. Supports sources up to 1920 x 1200 resolution at 24 - 60 Hz. Supports HDCP.

4. **DisplayPort 2**

DisplayPort 1.1a input. Connect a DisplayPort cable to the connector. Supports sources up to 1920 x 1200 resolution at 24 - 60 Hz. Supports HDCP.

5. **3G-SDI in**

6. **3G-SDI out**

Connect a 3G-SDI cable to distribute the 3G-SDI signal to another projector.

7. **HDMI 2**

HDMI 1.4b input supporting **Frame Sequential** and **Dual Pipe** 3D with HDCP 1.4. Also supports the domestic Blu-Ray formats. See supported signal input modes on page 113. Connect an **HDMI** cable to the connector.

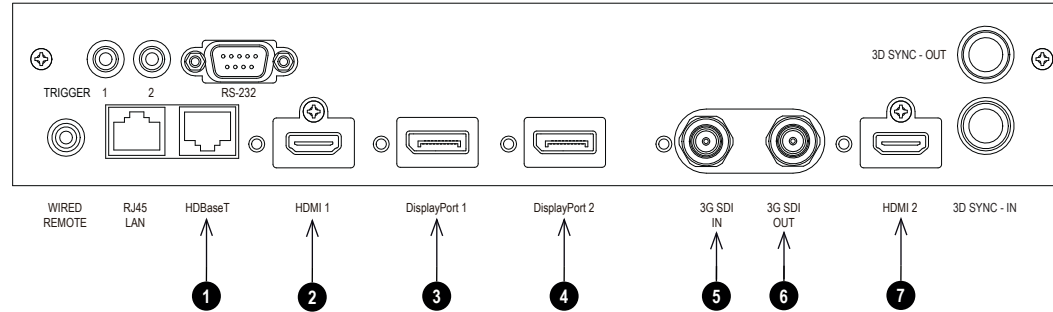

Notes



For simultaneous HDBaseT and LAN connectivity, a third-party distribution product can be utilised to combine HDBaseT video stream with LAN connection for delivery to the projector.

EDID on the DisplayPort, HDMI, and HDBaseT inputs

If you are using a computer graphics card or another source that obeys the EDID protocol, the source will automatically configure itself to suit the capability of the projector.

Otherwise refer to the documentation supplied with the source to manually set the resolution to the DMD™ resolution of the projector or the nearest suitable setting. Switch off the source, connect to the projector, then switch the source back on again.

Using DisplayPort / HDMI / HDBaseT switchers with the projector

When using a DisplayPort/HDMI/HDBaseT source switcher with the projector, it is important to set the switcher so that it passes the projector EDID through to the source devices.

If this is not done, the projector may not be able to lock to the source or display the source correctly as its video output timings may not be compatible with those of the projector. Sometimes this is called transparent, pass-through or clone mode. See your switcher's manual for information on how to set this mode.

1. Sources
2. Switcher
3. Projector

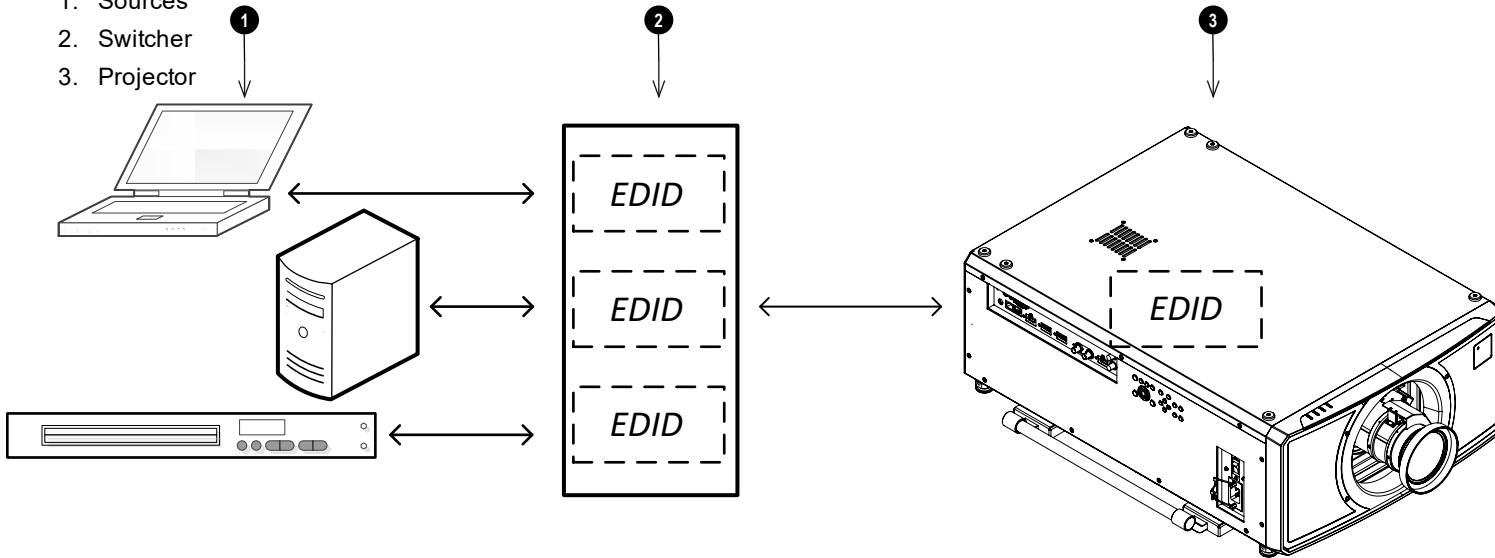

The EDIDs in the switcher should be the same as the one in the projector.

Notes

3D connections

1. HDMI 1 / Dual Pipe Left

HDMI 1.4b input supporting **Frame Sequential** and **Dual Pipe** 3D with HDCP 1.4. Also supports the domestic Blu-Ray formats. See supported signal input modes on page 113. Connect an **HDMI** cable to the connector.

2. DisplayPort 1

DisplayPort 1.1a input supporting **Frame Sequential** 3D source up to 120Hz. Connect a **DisplayPort** cable to the connector.

3. DisplayPort 2

DisplayPort 1.1a input supporting **Frame Sequential** 3D source up to 120Hz. Connect a **DisplayPort** cable to the connector.

4. HDMI 2 / Dual Pipe Right

HDMI 1.4b input supporting **Frame Sequential** and **Dual Pipe** 3D with HDCP 1.4. Also supports the domestic Blu-Ray formats. See supported signal input modes on page 113. Connect an **HDMI** cable to the connector.

5. Sync In / Sync Out

Sync In is the 3D sync input signal. Connect the 3D sync from your graphics card or server.

Sync Out is the 3D sync output signal. This is affected by settings in the 3D menu such as Dark Time and 3D Sync Offset. Connect this to an IR emitter or ZScreen.

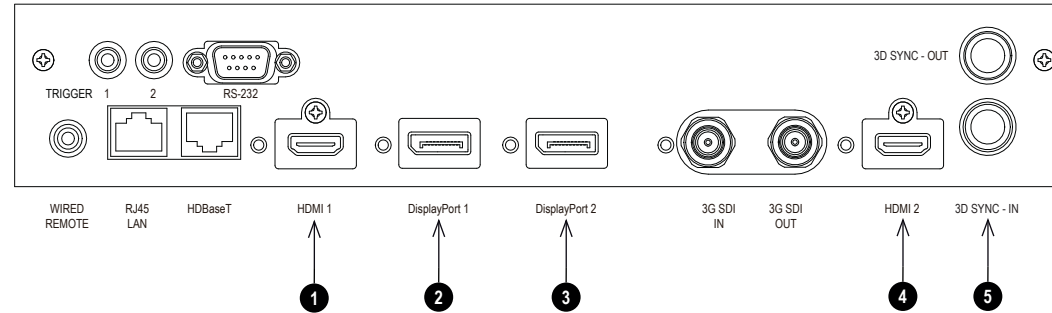

Notes

Dual Pipe 1080p, WUXGA and WQXGA+ 3D sources at up to 100 and 120Hz

1. Connect the left eye output to the **HDMI 1** socket and the right eye output to the **HDMI 2** socket.
2. Set **3D Format** in the **3D** menu to **Dual-Pipe**.

3D Sync

- 1. 3D Input
- 2. 3D Sync In
- 3. 3D Sync Out
- 4. IR emitter or Zscreen

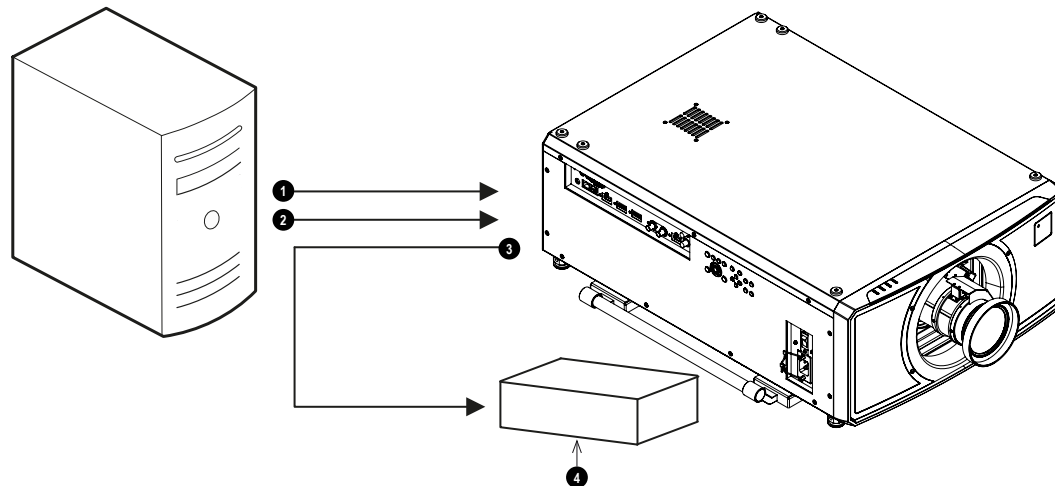

Notes

Control connections

1. Trigger 1 & Trigger 2

Trigger outputs are defined in the **Setup** menu. Each output can be triggered by one of the following conditions:

- **Screen trigger.** A trigger output can be used to control an electrically operated screen. The screen will be automatically deployed when the projector starts up and retracted when the projector shuts down.
- **Aspect ratio trigger.** A trigger output can be used to control screen shuttering for different aspect ratios.
- **RS232 trigger.** A trigger output can be used to control the screen or screen shuttering on receipt of an RS232 command.

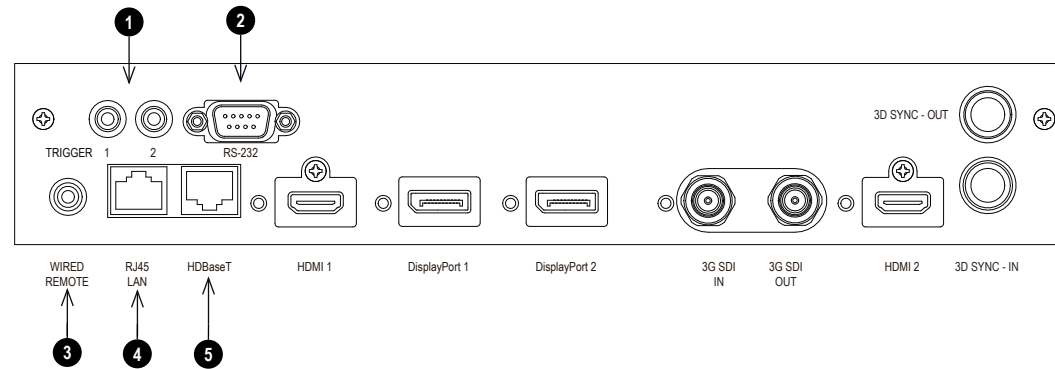

2. RS232

All of the projector's features can be controlled via a serial connection, using commands described in the **Protocol Guide**. Use a straight-through cable to connect directly to a computer.

3. Wired Remote

The remote control can be connected using a standard 3.5 mm mini jack cable (tip-ring-sleeve, or TRS).

4. HDBaseT/LAN

The projector's features can be controlled via a HDBase-T or LAN connection, using Digital Projection's **Projector Controller** application or a terminal-emulation program.

5. LAN

The projector's features can be controlled via a HDBase-T or LAN connection, using Digital Projection's **Projector Controller** application or a terminal-emulation program.

Notes

 For a list of all commands used to control the projector via LAN, see the **Protocol Guide** (available separately).

 Only one remote connection (RS232 or LAN) should be used at any one time.

 With a LAN connection the projector can serve a web page offering status and projector controls.



 **Projector Controller** is available for download, free of charge, from the Digital Projection website.

LAN connection examples

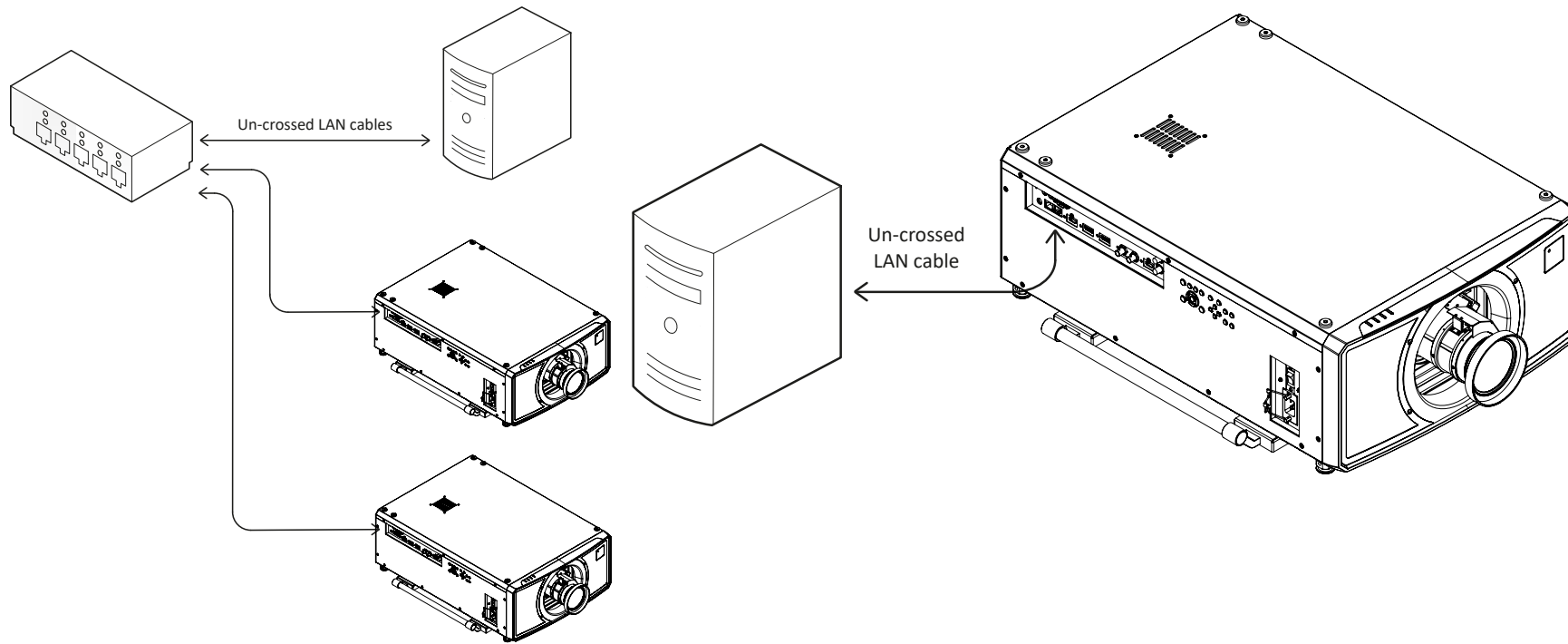
The projector's features can be controlled via a LAN connection, using Digital Projection's **Projector Controller** application or a terminal emulation program.



Notes

-  With a LAN connection the projector can serve a web page offering basic projector controls.
-  **Projector Controller** is available for download, free of charge, from the Digital Projection website.
-  For simultaneous HDBaseT and LAN connectivity, a third-party distribution product can be utilised to combine HDBaseT video stream with LAN connection for delivery to the projector.

RS232 connection example

All of the projector's features can be controlled via a serial connection, using commands described in the **Protocol Guide**.

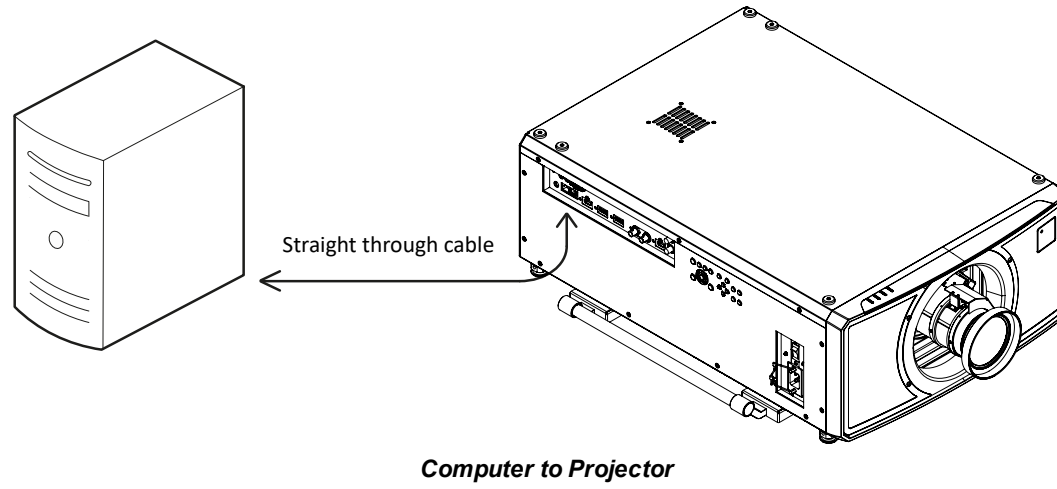

Notes

 The **Protocol Guide** is available separately

DIGITAL  **PROJECTION**

A Delta Associate Company

M-Vision 23000 Series

High Brightness Digital Video Projector

OPERATING GUIDE



Using the menus

Opening the Menu

Access the various menus using either the projector control panel or the remote control. On either device:

1. Press the **MENU** button.
The on-screen display (OSD) opens showing the list of available menus

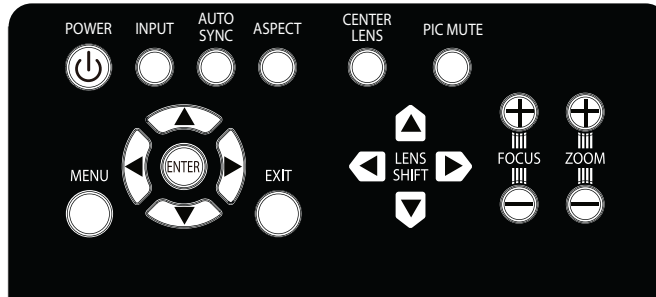

Projector control panel

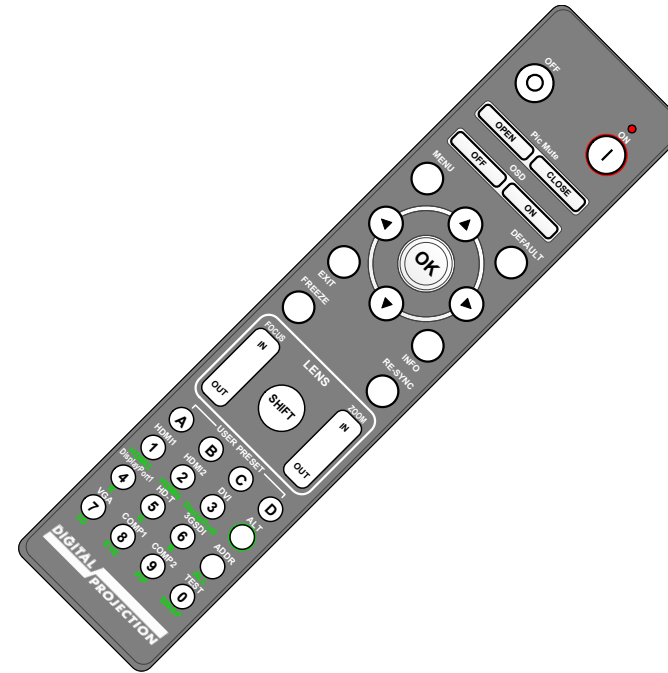

Remote control

Opening a submenu

Move up and down the list using the **UP** and **DOWN** arrow buttons.

To open a submenu:

1. Press **ENTER** on the control panel or **OK** on the remote control.

This guide refers to the above two buttons as **ENTER/OK**.

Notes

Exiting menus and closing the OSD

To go back to the previous page:

1. Press **EXIT**.

To close the OSD:

1. Press **MENU**.

Or:

1. Go back to the top level menu
2. Press **EXIT**.

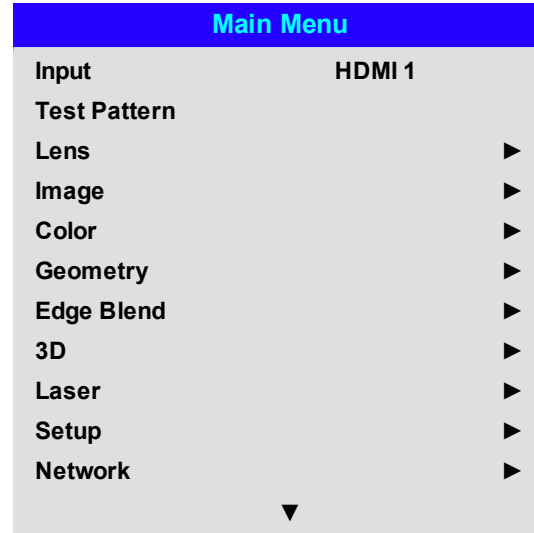

On Screen Display (OSD): Top Level Menu

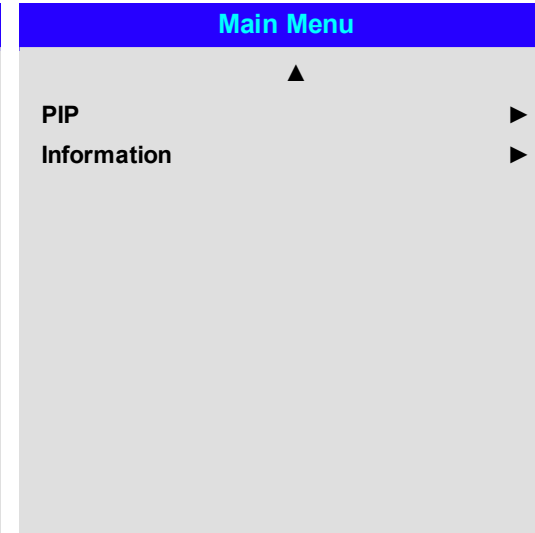

OSD: Top Level Menu Continued

Inside a menu

When you open a menu, the page consists of the following elements:

- Title bar at the top shows which menu you have accessed.
- Highlighted item
- Available and unavailable items Unavailable items appear a pale gray color. Whether an item is available may depend on other settings.
- The text or symbol to the right of an item shows whether the item:
 - has a value that can be changed (the current value is shown)
 - opens a sub-menu (an arrow button is displayed)
 - executes a command (the space to the right of the item is blank).

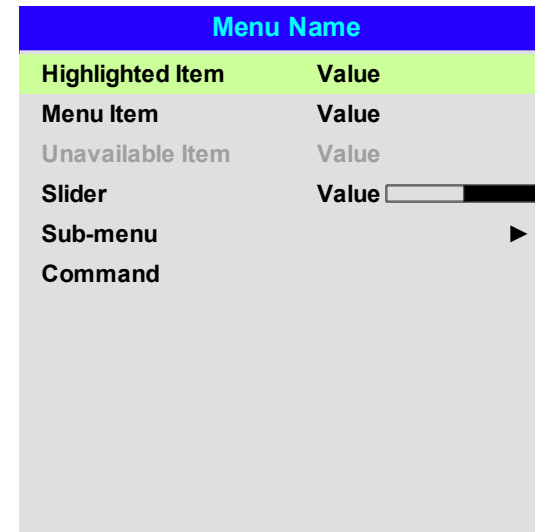

Inside a menu

 *The highlighted item has green background.*

Notes

Accessing sub menus

Use the **UP** and **DOWN** arrow buttons to highlight the sub-menu, then press **ENTER/OK**.

Executing commands

If the item contains a command, highlighting it reveals an **OK** button.

Press **ENTER/OK** to execute the highlighted command.

You may be asked for confirmation. Use the **ENTER/OK** to confirm, or **EXIT** to cancel.

Menu Name	
Menu Item	Value
Highlighted Command	OK

Highlighted Command

Command Name
Warning All [Menu] values will be lost.
Press OK to confirm
Press Exit to cancel

Confirmation Dialog

Notes

Editing projector settings

If the highlighted menu item contains a list of values to choose from, you can change the value by doing the following:

1. Highlight the menu item and press **ENTER/OK**.
2. In the list of values that opens, use the **UP** and **DOWN** arrow buttons to highlight a value, then press **ENTER/OK** again to select the highlighted value.



List of Values



Slider

Notes



Some menu items may be unavailable due to settings in other menus. Unavailable menu items appear gray

Using a slider to set a value

Some parameters show a slider. To set such a parameter:

1. Press the **LEFT** or **RIGHT** arrow button, or **ENTER/OK**. The arrow buttons will open the slider and adjust the value at the same time. **ENTER/OK** will open the slider without altering the initial value.
2. Use the **LEFT** and **RIGHT** arrow buttons to move the slider.
3. When ready, press **RETURN** to exit the slider and return to the menu.

Editing numeric values

Some parameters take numeric values without using sliders - for example, color matching values or IP addresses.

1. Use the **UP** and **DOWN** arrow buttons to highlight the row containing the numeric field you wish to edit.
2. Press **ENTER/OK** to enter edit mode. A numeric field in edit mode is white text on blue background.
3. In edit mode:
 - Use the **UP** arrow button to increase the numeric value.
 - Use the **DOWN** arrow button to decrease the numeric value.
4. Use the **LEFT** and **RIGHT** arrow buttons to edit the next or previous numeric fields within the same row.
5. Once ready, press **ENTER/OK** to exit edit mode.

Data	
Row	x: 0.658 y: 0.339
Highlighted Row	x: 0.315 y: 0.662
Row	x: 0.146 y: 0.043
Row	x: 0.276 y: 0.283

Notes

Using the projector

Main Menu

- **Input**

Press **ENTER/OK** to open the list of available inputs. Use the **UP** and **DOWN** arrow buttons to select an input from the list, then press **ENTER/OK** to confirm your choice. Press **EXIT** to return to the main menu.

- **Test Pattern**

White, Black, Red, Green, Blue, Checkerboard, Crosshatch, V Burst, H Burst, Color Bar, Pluge, Off.
Use the **LEFT** and **RIGHT** arrow buttons to switch between values.

- **Lens, Image, Color, Geometry, Edge Blend, 3D, Laser, Setup, Network.**

Press **ENTER/OK** to open these menus and access various settings.

Press the **DOWN** arrow at the bottom of the page to access additional menus:

- **PIP, Information.**

Press **ENTER/OK** to open these menus and access various settings.

Press the **UP** arrow to return to the previous page.

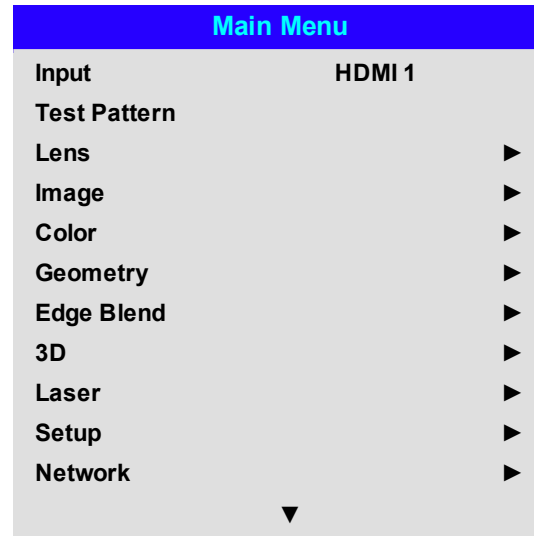

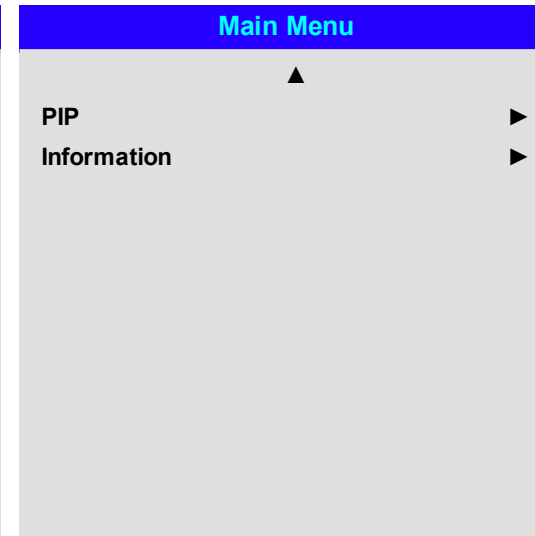

Main Menu, page 1



Main menu, page 2

Notes

 See Signal inputs on page 38 for information about the available inputs and connections.

 Selecting a test pattern hides the OSD. Press **EXIT** to hide the test pattern, and then press **MENU** to show the OSD

Lens menu

- **Lens Lock**
When this feature is **On**, all other Lens menu items are disabled.
- **Lens Control**
Opens a sub-menu, see below.
- **Center Lens**
Centers the lens.
- **Lens Memory**
Opens a sub-menu, see next page.

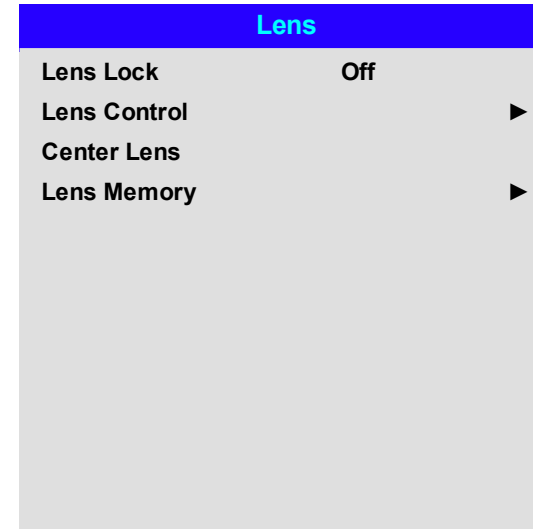

Lens control

Lens Control settings operate in **Zoom/Focus Adjustment** and **Shift Adjustment** mode. Press **ENTER/OK** to switch between modes.

When in **Zoom/Focus Adjustment** mode:

- Use the **UP** and **DOWN** arrow buttons to adjust **Zoom**.
- Use the **LEFT** and **RIGHT** arrow buttons to adjust **Focus**.

When in **Shift Adjustment** mode, use the arrow buttons to adjust **Shift**.

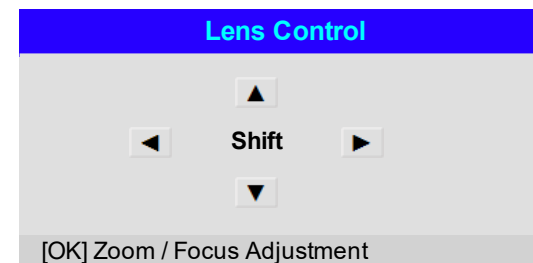
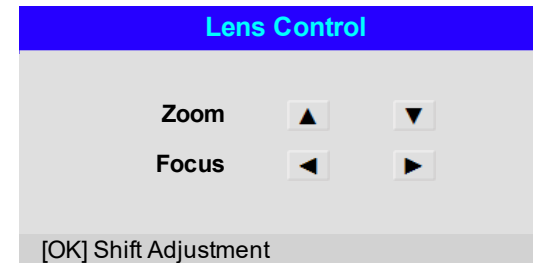

Notes

Lens memory

This menu allows you to load, save and delete up to ten lens presets, containing horizontal and vertical shift adjustment information.

Use **Clear Memory** to delete a memory preset if you need to save a new combination of lens settings in its place. Overwriting a saved memory preset is not possible.

Lens Memory

- Load Memory** ▶
- Save Memory** ▶
- Clear Memory** ▶



Notes

The lenses for the M-Vision series can only store horizontal and vertical shift information. Zoom and focus memory is not available.

Lens Load Memory

Memory 1	OK
Memory 2	
Memory 3	
Memory 4	
Memory 5	
Memory 6	
Memory 7	
Memory 8	
Memory 9	
Memory 10	

Lens Save Memory

Memory 1	OK
Memory 2	
Memory 3	
Memory 4	
Memory 5	
Memory 6	
Memory 7	
Memory 8	
Memory 9	
Memory 10	

Lens Clear Memory

Memory 1	OK
Memory 2	
Memory 3	
Memory 4	
Memory 5	
Memory 6	
Memory 7	
Memory 8	
Memory 9	
Memory 10	

Image

- **Picture Mode**

Choose from **High Bright**, **Presentation** and **Video**.

Use a different setting depending the type of input source.

Press **ENTER/SELECT** to open the list.

Use the **UP** and **DOWN** arrow buttons to select a picture mode from the list, then press **ENTER/OK** to confirm your choice.

Press **EXIT** to return to the main menu.

- **Dynamic Black**

Set to On to allow for increased contrast in darker scenes by modulating the light source.

- **Light Off Timer**

When **Dynamic Black** is **On**, the **Light Off Timer** will define if laser light source will turn off after a period of time has passed. The options are: **Disable**, **0.5**, **1.0**, **1.5**, **2.0**, **3.0**, **4.0** seconds.

- **Gamma**

Choose a de-gamma curve from **1.0**, **1.8**, **2.0**, **2.2**, **2.35**, **2.5**, **S-Curve**, and **DICOM**.

Used correctly, the **Gamma** setting can improve contrast while maintaining good details for blacks and whites.

If excess ambient light washes out the image and it is difficult to see details in dark areas, lower the **Gamma** setting to compensate. This improves contrast while maintaining good details for blacks.

Conversely, if the image is washed out and unnatural, with excessive detail in black areas, increase the setting.

S-Curve is an enhanced mid-tone gamma.

DICOM is a simulated DICOM display, which can be used for training applications.

- **Brightness, Contrast, Saturation, Hue, Sharpness**

Highlight the setting you wish to edit, and then press **ENTER/OK**, or the **LEFT** or **RIGHT** arrow button to open the slider.

Use the **LEFT** and **RIGHT** arrow buttons to adjust the slider.

Press **EXIT** to close the slider and return to the menu, or **MENU** to close the slider and return to the projected image.

- **Noise Reduction**

Choose a level of noise reduction from **0 - 3**.

- **Freeze**

Freezes the current frame.

- **Resync**

Press **ENTER/OK** to force the projector to resynchronise with the current input

Image	
Picture Mode	High Bright
Light Off Timer	-----
Dynamic Black	Off
Gamma	2.2
Brightness	100 
Contrast	100 
Saturation	100 
Hue	100 
Sharpness	10 
Noise Reduction	Off
Freeze	
Resync	

Notes



This product includes a DICOM simulation feature intended for training and other non-medical diagnosis purposes.

Color

Notes

Color	
Color Space	Auto
Color Mode	ColorMax
ColorMax	Peak
Manual Color Matching	▶
Color Temperature	Native
Gains and Lifts	▶
3 Color Matching	▶
7 Color Matching	▶

Color Space

In most cases, the Auto setting determines the correct colorspace to use. If it does not, you can choose a specific colorspace:

Choose from **Auto**, **YPbPr**, **YCbCr**, **RGB PC** and **RGB Video**.

Color	
Color Space	Auto
Color Mode	Auto
ColorMax	YPbPr
Manual Color Matching	YCbCr
Color Temperature	RGB PC
Gains and Lifts	RGB Video
3 Color Matching	
7 Color Matching	

Color Mode

The projector can work in the following color modes:

- **ColorMax**
- **Manual Color Matching**
- **Color Temperature**
- **Gains and Lifts**
- **3 Color Matching**
- **7 Color Matching**

ColorMax

1. Set **Color Mode** to **ColorMax**.
2. Navigate to the **ColorMax** setting.
3. Choose from **HDTV, Peak, User 1, User 2, 3 Color Matching** and **7 Color Matching**. **User 1** and **User 2** are user-defined color gamuts set via the **Setup > ColorMax** menu.

Color	
Color Space	Auto
Color Mode	ColorMax
ColorMax	ColorMax
Manual Color Matching	Manual Color Matching
Color Temperature	Color Temperature
Gains and Lifts	Gains and Lifts
3 Color Matching	3 Color Matching
7 Color Matching	7 Color Matching

Color	
Color Space	Auto
Color Mode	ColorMax
ColorMax	Peak
Manual Color Matching	HDTV
Color Temperature	Peak
Gains and Lifts	User 1
3 Color Matching	User 2
7 Color Matching	3 Color Matching
	7 Color Matching

Notes

 Only one color mode can be selected at a time. Settings used by the other color modes are disabled.

 See Setup on page 87 for further information about setting up the User 1 and User 2 color gamuts.

Manual Color Matching

1. Set **Color Mode** to **Manual Color Matching**.
2. Open the **Manual Color Matching** submenu.

Here you can do the following:

- Switch **Auto Test Pattern On** and **Off**.
- Adjust **Hue, Saturation and Gain** settings for each individual color to improve the color balance of the projected image.
- Adjust white balance RGB values.
- Reset all values.

Manual Color Matching	
Auto Test Pattern	Off
Red	▶
Green	▶
Blue	▶
Yellow	▶
Cyan	▶
Magenta	▶
White Balance	▶
Reset	

Manual Color Matching - Red	
Hue	100 <input type="text"/>
Saturation	100 <input type="text"/>
Gain	100 <input type="text"/>

Manual Color Matching - White	
Red	100 <input type="text"/>
Green	100 <input type="text"/>
Blue	100 <input type="text"/>

Notes



See Color matching parameters explained on the next page for more details about the Hue, Saturation and Gain settings.

Color matching parameters explained

The levels of hue, saturation and gain in the Manual Color Matching menu change the color values in the following ways:

1. **Hue** Specifies the position of each color (red, yellow, green, cyan, blue and magenta) relative to its neighboring colors.
2. **Saturation** Specifies the level of white in each color (i.e. how “pale” each color is).
3. **Gain** Controls the amount of light that goes into each color, i.e. the lowest gain would produce black.

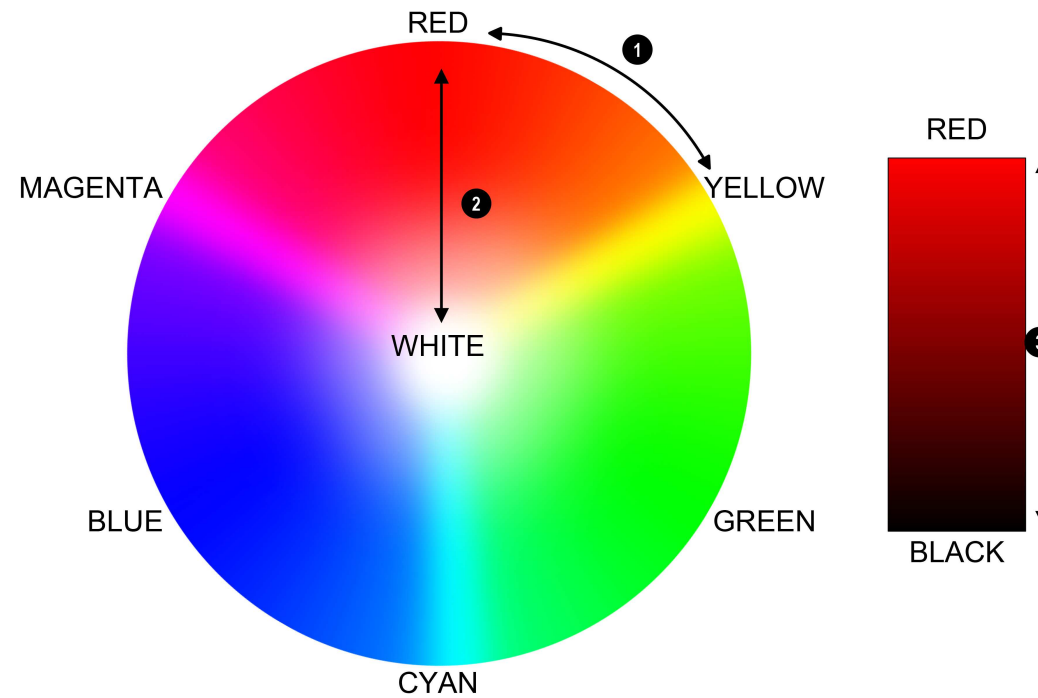

Notes

Color Temperature

1. Set **Color Mode** to **Color Temperature**.
2. Navigate to the **Color Temperature** setting. Choose a value from **3200K** (warmer) to **9300K** (cooler) or **Native** (no correction).

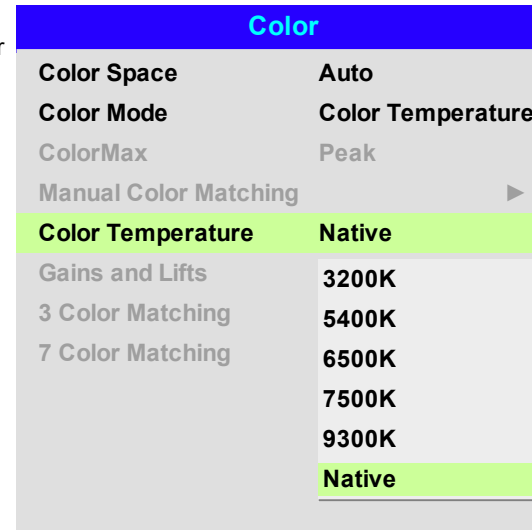

Notes

Gains and Lifts

1. Set **Color Mode** to **Gains and Lifts**.
2. Open the **Gains and Lifts** submenu.

Lifts allow you to adjust black levels of individual colors, while gains adjust the bright part of the scale.

Set the sliders as required



3 Color Matching

1. Set **Color Mode** to **3 Color Matching**.
2. Open the **3 Color Matching** submenu.

Here you can do the following:

- Switch **Auto Test Pattern On** and **Off**.
- Adjust the RGB settings for each individual color to alter its **hue**.
- Adjust the **Gain** value of the white balance.
- Reset all values.

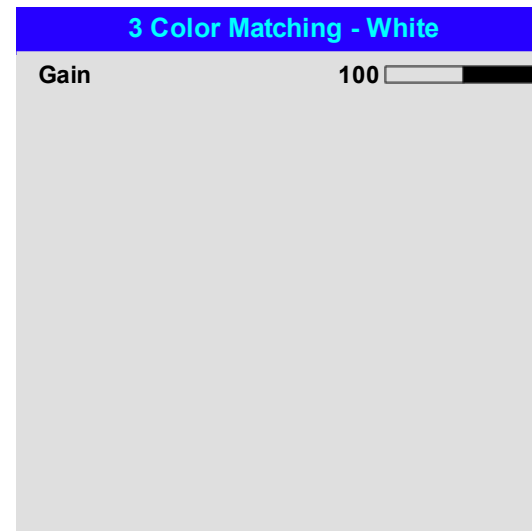
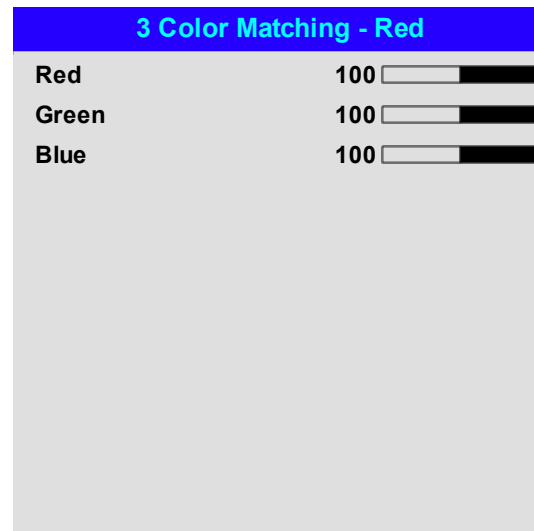
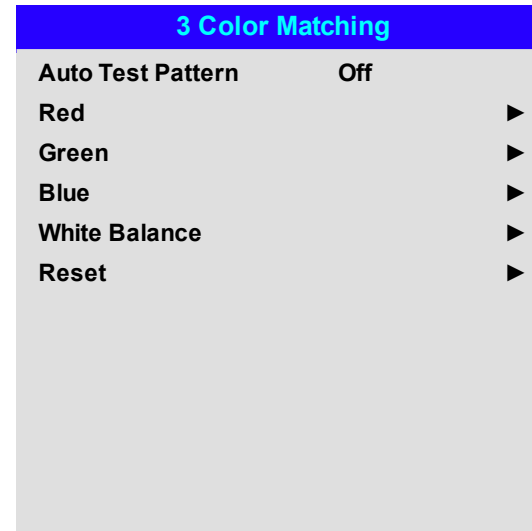

Notes



In 3 color and 7 color matching, the contribution of red, green and blue can be adjusted for each color. This allows the tint of each color to be matched across multiple projectors.

7 Color Matching

1. Set **Color Mode** to **7 Color Matching**.
2. Open the **7 Color Matching** submenu.

Here you can do the following:

- Switch **Auto Test Pattern On** and **Off**.
- Adjust the RGB settings for each individual color to alter its **hue**.
- Adjust the **Gain** value of the white balance.
- Reset all values.

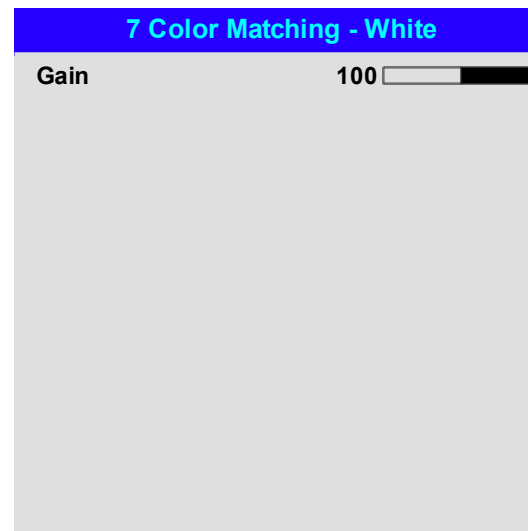
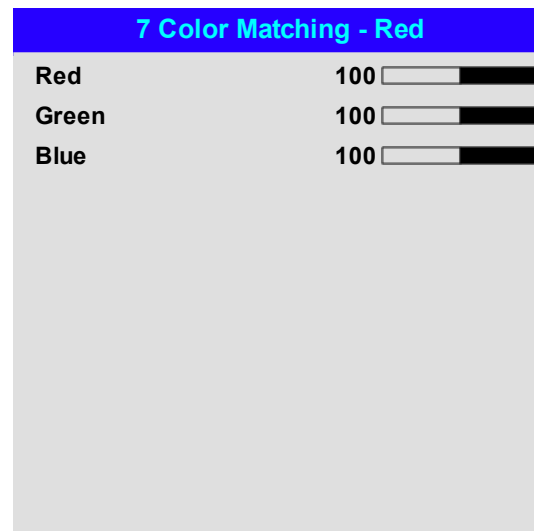
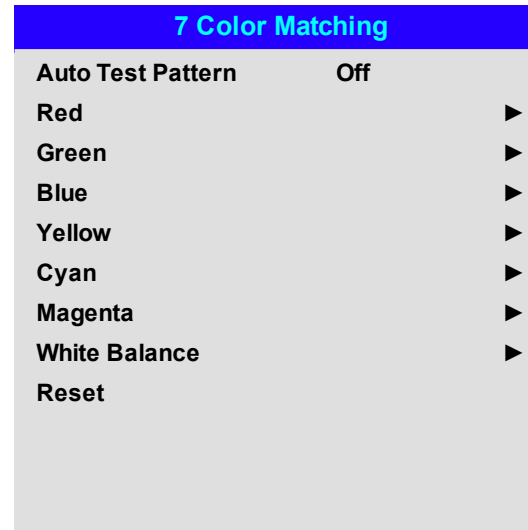

Notes

In 3 color and 7 color matching, the contribution of red, green and blue can be adjusted for each color. This allows the tint of each color to be matched across multiple projectors.

Geometry

This menu allows you to compensate for image distortions caused by an unusual projection angle or irregular screen surface.

Geometry	
Aspect Ratio	Source
Digital Zoom	▶
Overscan	Off
Blanking	▶
Warping Mode	Keystone ▶
Warping Grids	Off
Custom Masking	Off
Warp Filter	▶

Notes



Select the **Warping Mode** you want to use before opening its submenu.

Aspect Ratio

This feature defines the aspect ratio of the source. Use the **Setup > Screen Setting** to define the screen aspect ratio.

If you choose a preset aspect ratio from here, it will give you the best fit for your selection.

Choose from:

- 5:4
- 4:3
- 16:10
- 16:9
- 1.88
- 2.35
- TheaterScope
- Source
- Unscaled



Image scaling and aspect ratio are also influenced by **Setup > Screen Setting**.



See **TheaterScope** setting on the facing page for further information about the **TheaterScope** aspect ratio.

Theaterscope setting

The **TheaterScope** setting is used in combination with an anamorphic lens to restore 2.35:1 images packed into a 16:9 frame. Such images are projected with black lines at the top and bottom of the 16:9 screen to make up for the difference in aspect ratios.

Without an anamorphic lens and without the TheaterScope setting applied, a 16:9 source containing a 2.35:1 image looks like this:

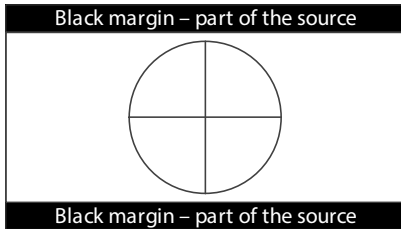

If we change the setting to TheaterScope, the black lines will disappear but the image will stretch vertically to reach the top and bottom of the DMD™:

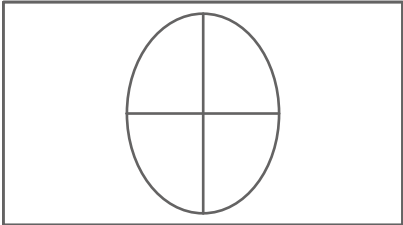

An anamorphic lens will stretch the image horizontally, restoring the original 2.35 ratio:

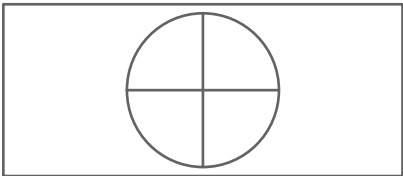

Notes

 TheaterScope is used with an anamorphic lens.

 If you use TheaterScope, set your screen aspect ratio to 16:9.

Digital Zoom

Digital zooming enlarges a section of the image, while the area outside the enlarged section is cropped out to preserve the overall image size.

- **Digital Zoom** defines the level of zoom that needs to be applied. If **Digital Zoom** is set to 0, then the other settings in the menu will be disabled.
- **Digital Pan** and **Digital Scan** specify the area that is being enlarged:
 - **Digital Pan** adjusts the horizontal coordinates.
 - **Digital Scan** adjusts the vertical coordinates.

The **Reset** command restores the default **Digital Zoom**, **Digital Pan** and **Digital Scan** values.

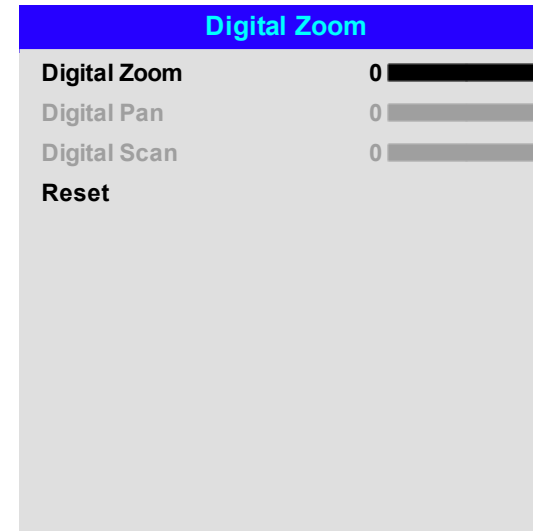

Notes



Digital Zoom is a temporary setting and not retained after an input change or power cycle.

Overscan

Use this setting to compensate for noisy or badly defined image edges.

Crop removes unwanted artifacts from the edges of your image by cropping the edges.

Zoom increases the size of the image to force the edges off-screen

Geometry	
Aspect Ratio	Source
Digital Zoom	▶
Overscan	Off
Blanking	Off
Warping Mode	Crop
Keystone	Zoom
4 Corners	
Rotation	▶
Pincushion / Barrel	▶
Arc	▶
Custom Warp	▶
Warp Filter	▶

Notes

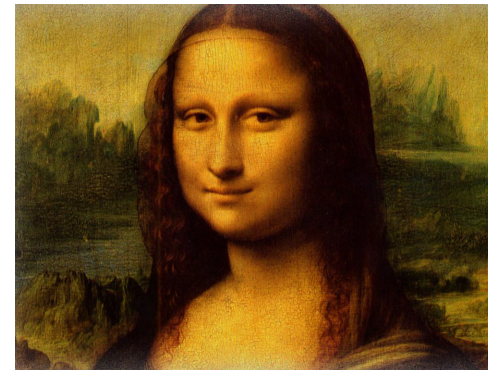
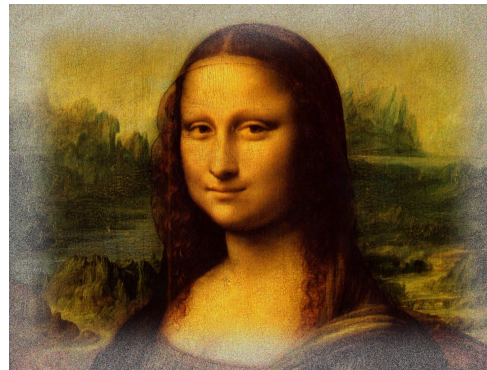

Blanking

Use this feature to:

- fit an odd-sized screen;
- cut off timecode dots in the top line of a picture;
- cut off subtitles, etc.

Select the edge you wish to blank and use the **LEFT** and **RIGHT** arrow buttons to determine the amount of correction.

Use the **Reset** command to restore blanked edges.

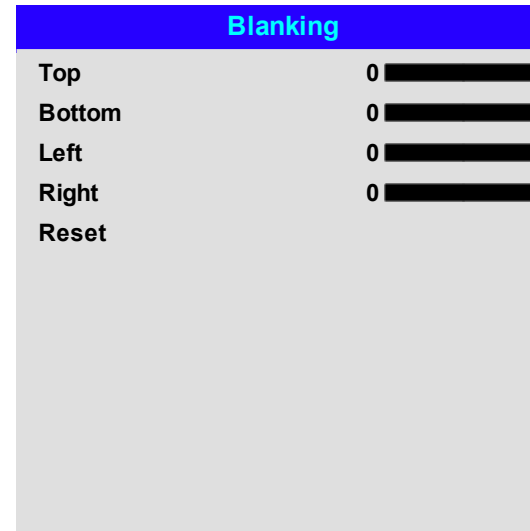

Notes

Keystone

Use this setting to compensate for any distortion caused by the projector being in a different horizontal or vertical plane to the screen.

Keystone

H Keystone	0 <input type="text"/>
V Keystone	0 <input type="text"/>
Rotation	0 <input type="text"/>
Reset	

Notes



Max rotation in Keystone is reduced from normal rotation

The projector is positioned at an angle

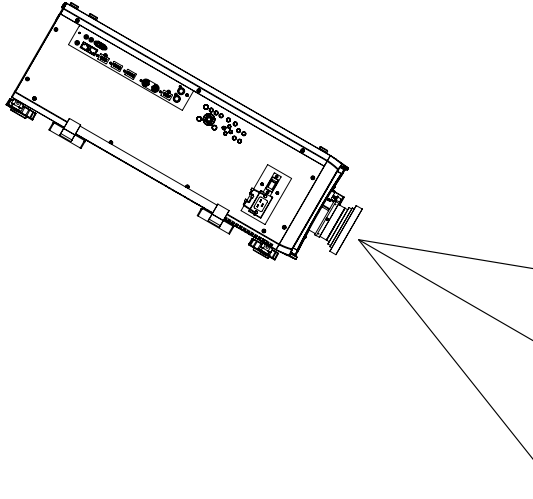

The resulting image is distorted

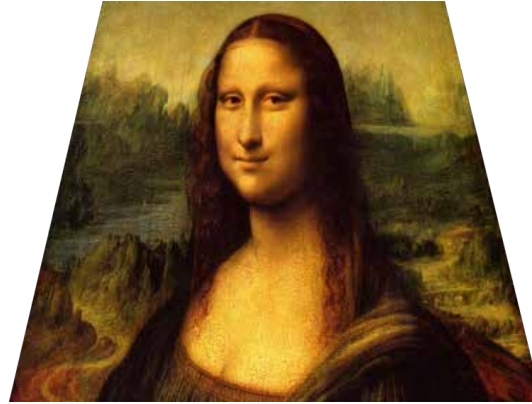

The image is corrected when Keystone is applied



Notes

1. **Projector to the left** The projector is positioned to the left of the screen. To correct, apply a positive **Horizontal Keystone** value using the **RIGHT** arrow button.
2. **Projector to the right** The projector is positioned to the right of the screen. To correct, apply a negative **Horizontal Keystone** value using the **LEFT** arrow button.
3. **Projector high** The projector is positioned above the screen at a downward angle. To correct, apply a negative **Vertical Keystone** value using the **DOWN** arrow button.
4. **Projector low** The projector is positioned below the screen at an upward angle. To correct, apply a positive **Vertical Keystone** value using the **UP** arrow button.
5. **Projector straight** The projector is directly opposite the screen at a right angle both horizontally and vertically. No correction is needed.

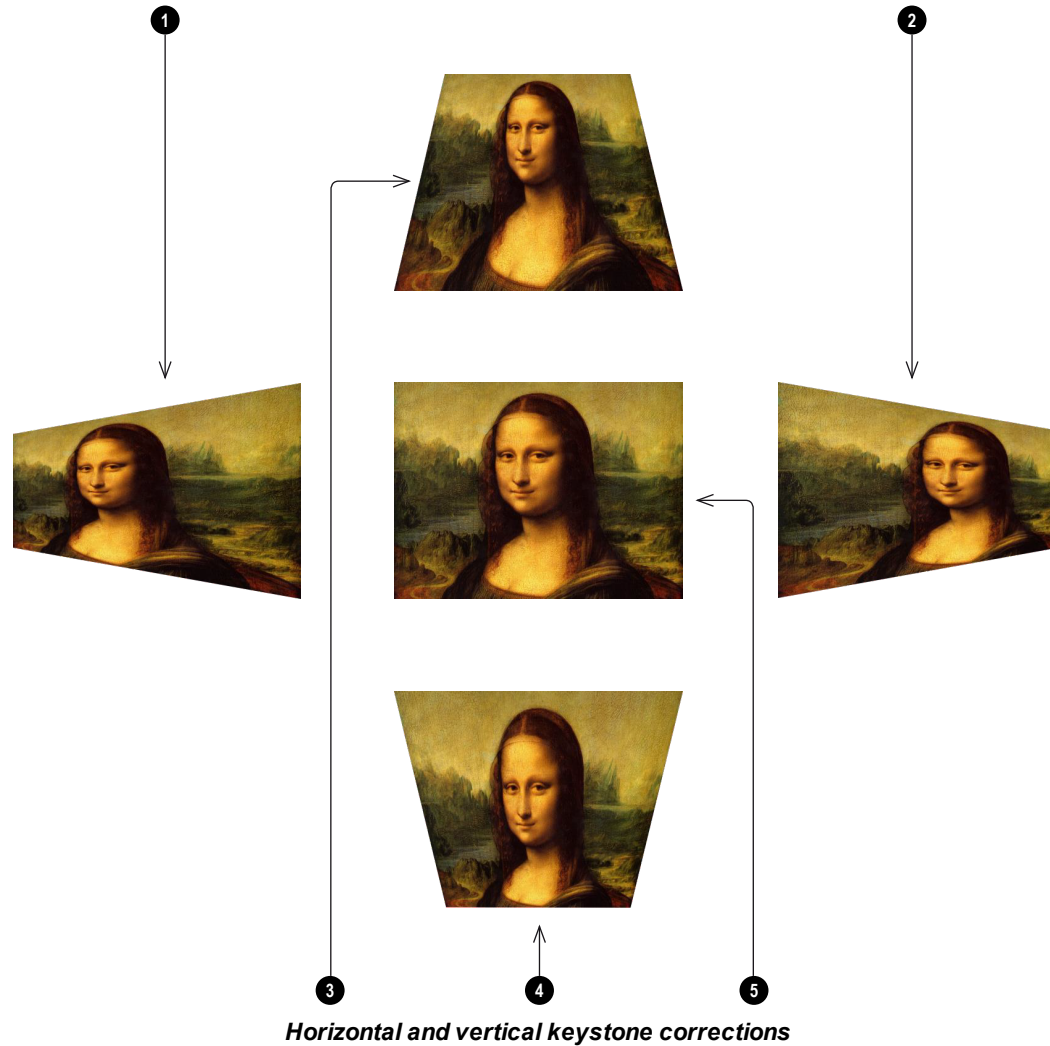

Notes

For each corner, apply horizontal and / or vertical correction as necessary to restore the rectangular shape of the image.

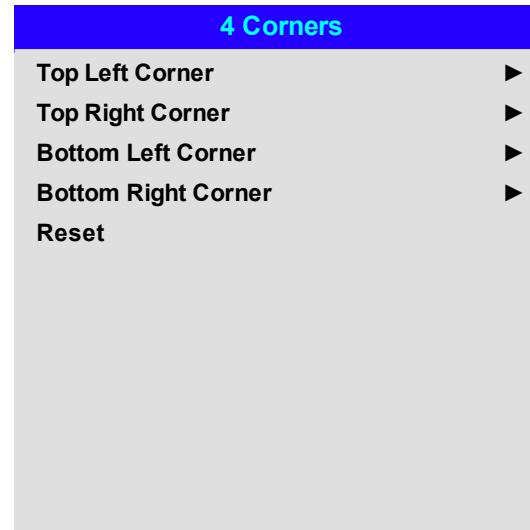

Notes
*Corner corrections provide a simple setup for awkward installations and irregular shaped screens that may distort the image. To apply a similar (but less flexible) correction, while preserving the original aspect ratio of the image, use the **Keystone** menu.*

Top right corner example

In this illustration, the top right corner requires both horizontal and vertical correction.

Top Right Corner Adjustment

Top Right Corner x ◀ 0 ▶

Top Right Corner y ▲ 0 ▼

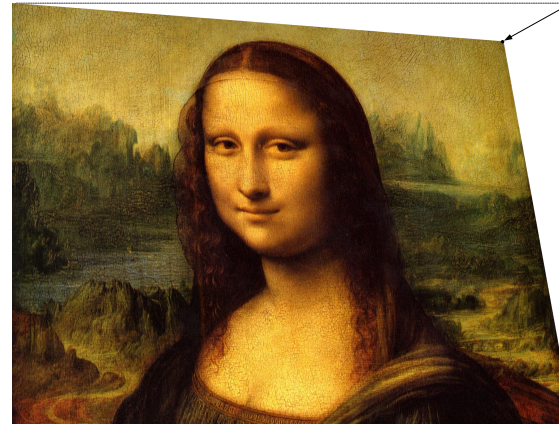

Notes

Rotation

Use this feature for example to correct a mounting error causing the image not to be level with the screen.

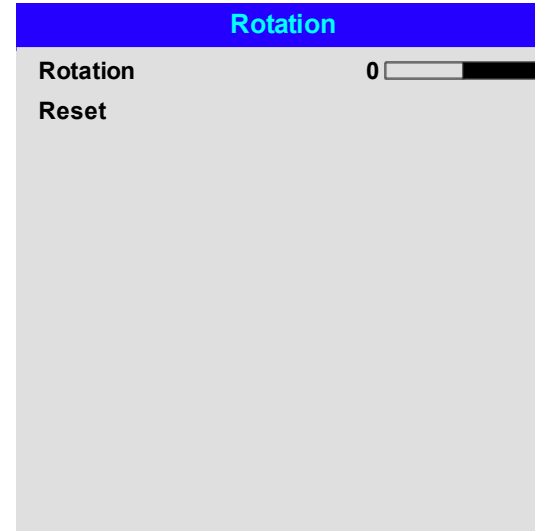

Notes

Rotation example

- 1. DMD™ area**
The DMD™ is not rotated. It still covers the area that would be occupied by the image without correction.
- 2. Rotated image**
The image is smaller than the surrounding DMD™ area. It is scaled in order to remain within the DMD™ area.
- 3. Angle of rotation**
Each step on the slider is 0.25° of rotation. In this example the angle is 5°, therefore Rotation value is 20.

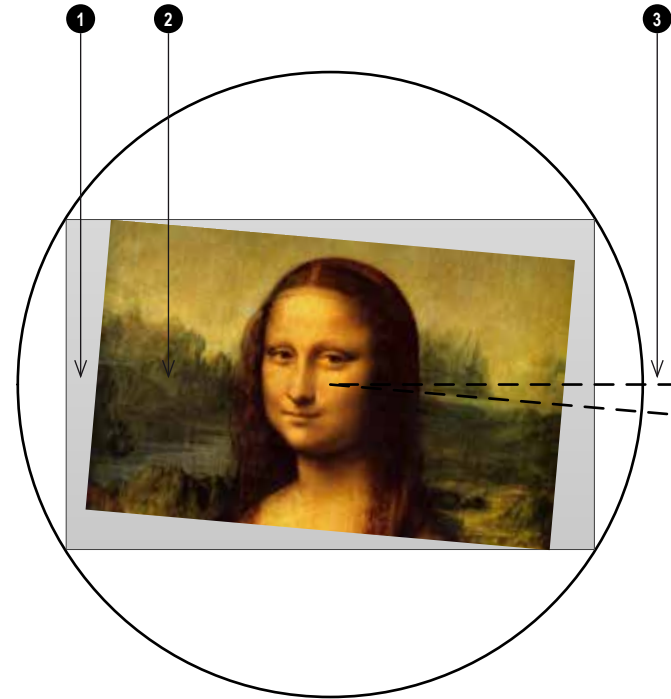
**Notes**

Pincushion / Barrel

Pincushion or barrel distortions are the result of poor or incorrect tensioning of the screen or using a surface that is not flat.

Use the **Pincushion / Barrel** control to compensate electronically for such distortions.

You can also use this menu to make simple panoramic screen corrections without using external processors.

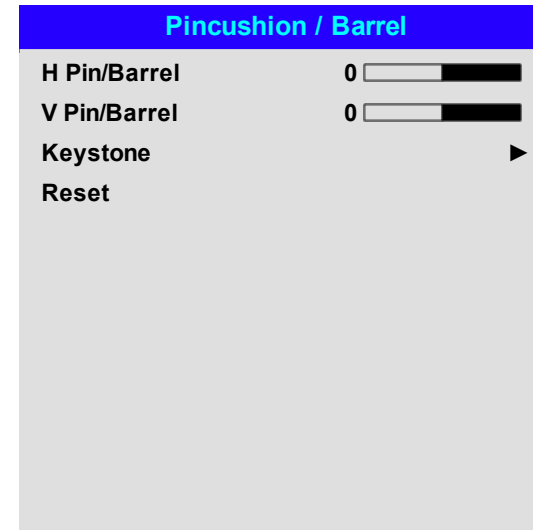

Notes

Pincushion/ Barrel example

The illustration shows pincushion and barrel correction applied both horizontally and vertically, in equal measures.

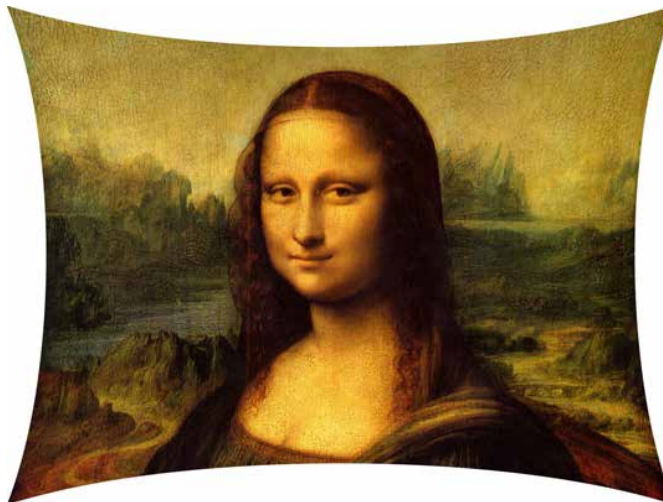

Pincushion

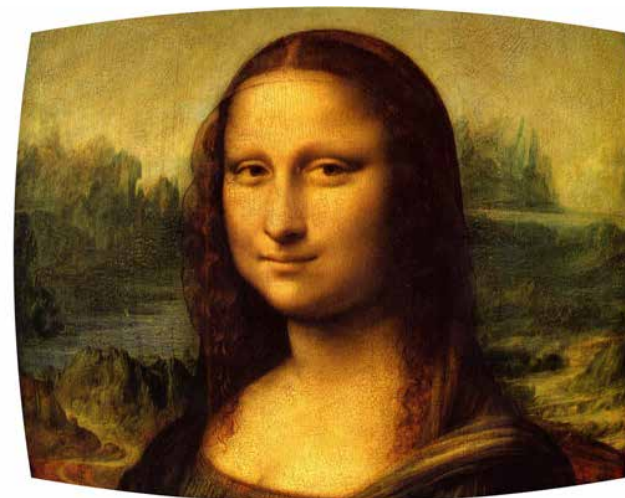

Barrel

Arc

This feature is similar to **Pincushion / Barrel** but allows you to apply curvature to each edge of the image independently so you can have any combination of corrections.

Arc	
Top	0 <input type="range"/>
Bottom	0 <input type="range"/>
Left	0 <input type="range"/>
Right	0 <input type="range"/>
Reset	



Notes

 Please note that a positive **Arc** value on any edge will reduce the image size as the projector needs to maintain the aspect ratio. A negative **Arc** value will not affect the overall image size.

Custom Warp

This feature permits selection of predefined User warp maps. Use the Projector Controller PC application to create the custom warp maps.

Custom warp maps provide non-linear curvature correction for curved or spherical screens and other irregular shaped surfaces such as building mapping.

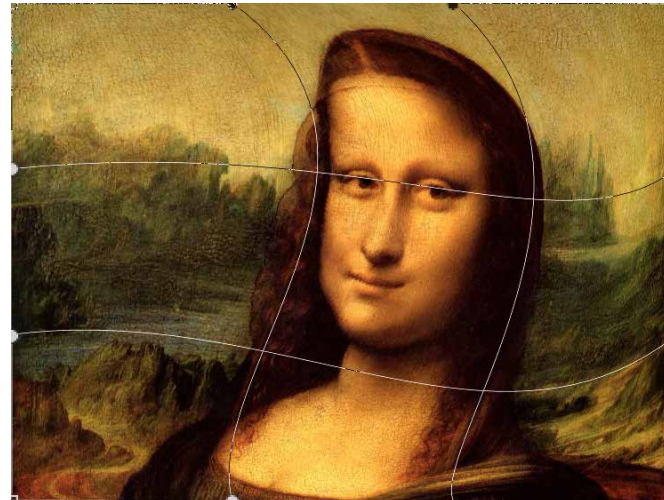
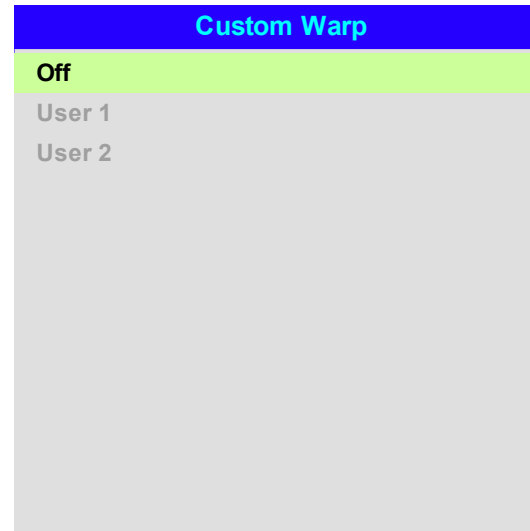

Notes

Warping Grids

Switch warping grids on to overlay a grid onto the warped image.

Custom Masking

This feature permits selection of predefined masks. Use the Projector Controller PC application to create the custom masks.

Use this feature to apply a custom mask to an area of the image. Select from **Off**, **User 1** and **User 2**.

Warp Filter

This feature can be used to enhance the image after a geometry warp correction is applied.

Choose between Auto and Manual modes. In Manual mode you can set both Horizontal and Vertical filters. The filters smooth the geometry / warp correction when set to lower values and edge enhance when set to higher values.



Notes

Edge Blend

Use this menu to blend together images from an array of two or more projectors. The feature feathers the light output of the projector within the edges that overlap with other projectors in the array: as a result, the overlapping edges are evenly lit and easily blend in with the rest of the image.

- **Edge Blend**
Enable and disable **Edge Blend**
- **Align Pattern**
Add markers to the image showing the edges of the blend area and making the overlaps more visible to help adjust the physical position of the projectors in the array.
- **Blend Start**
Determine the start point of the blended regions. top, bottom, left right
- **Blend Width**
Determine the width of the blended regions.
- **Black Level Uplift**
Adjust black levels to compensate if the blended regions appear brighter than the rest of the image.
- **Reset**
Reset all **Edge Blend** settings to their factory default values.

Edge Blend	
Edge Blend	On
Align Pattern	Off
Blend Start	▶
Blend Width	▶
Black Level Uplift	▶
Reset	

Notes

 When **Edge Blend** is set to **Off**, all other edge blend settings are disabled.

 The picture in the blend region needs to be delivered to all overlapping projectors, which may require a special setup of the source.

Blend Start

Use the blend start options to deactivate pixels at the edge of the image and set the start point for the blended region. Use the **LEFT** and **RIGHT** arrow buttons to set the start point of the blended regions:

1. Top
2. Bottom
3. Left
4. Right

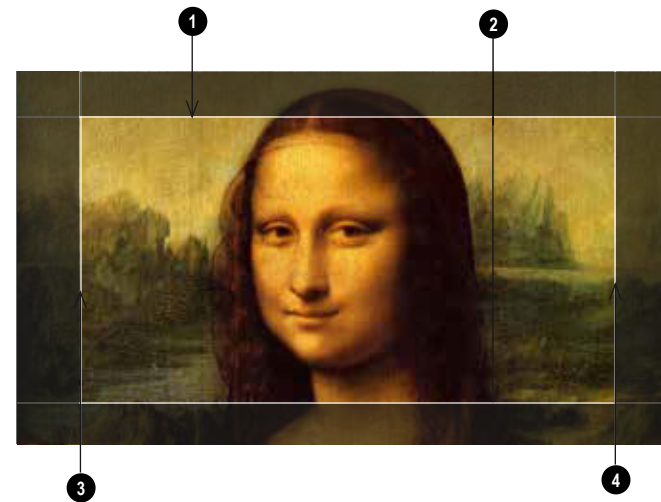
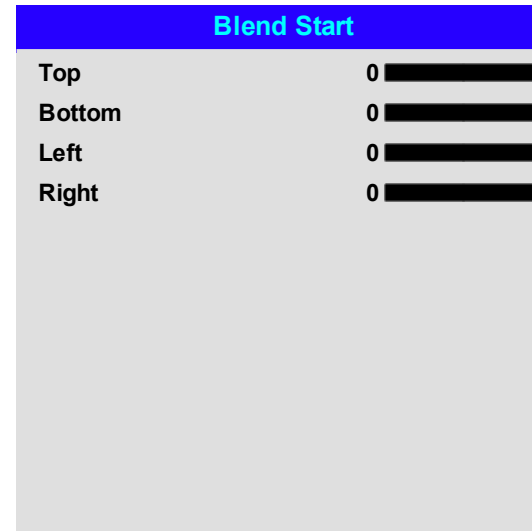

Notes

Blend Width

Use the **LEFT** and **RIGHT** arrow buttons to set the width of the blended regions:

1. Top
2. Bottom
3. Left
4. Right

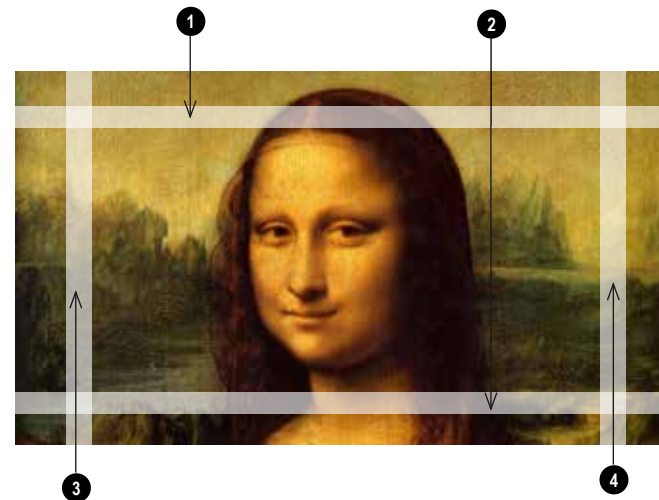

Notes

Black Level Uplift

Black in the blended regions appears less dark than in the rest of the image. To compensate for this, use this menu to raise the black levels of the rest of the image:

- Set **All** to the required amount of black level correction. This will apply equal correction to the black levels of all colors
- If necessary, use the individual color sliders (**Red**, **Green** and **Blue**) for fine adjustment.

You may experience artifacts at the edges where the blended region of one projector overlaps the *pond of mirrors* of its neighbor. In the example below, the blended image comes from *two projectors*, ① and ②.

Both images have black level uplift applied; as a result, *artifacts* ③ and ④ have emerged at the edges where the black level uplift region of one projector overlaps the pond of mirrors of the other.

To remove the artifacts, you need to slightly reduce the size of the black level uplift region of each projector so it does not overlap the pond of mirrors of the other projector.

- Depending on your array, use **Top**, **Bottom**, **Left** and/or **Right** to reduce the black level uplift size. In the example below, use the **Right** slider of the **projector on the left** ① to remove the *artifact on the right* ④, and the **Left** slider of the **projector on the right** ② to remove the *artifact on the left* ③.

Black Level Uplift

Select Area	
Top	0 <input type="range"/>
Bottom	0 <input type="range"/>
Left	0 <input type="range"/>
Right	0 <input type="range"/>
Color Adjustment	
All	◀ ▶
Red	0 <input type="range"/>
Green	0 <input type="range"/>
Blue	0 <input type="range"/>



Notes

Enable **Align Pattern** from the **Edge Blend** menu to see the black level uplift area.

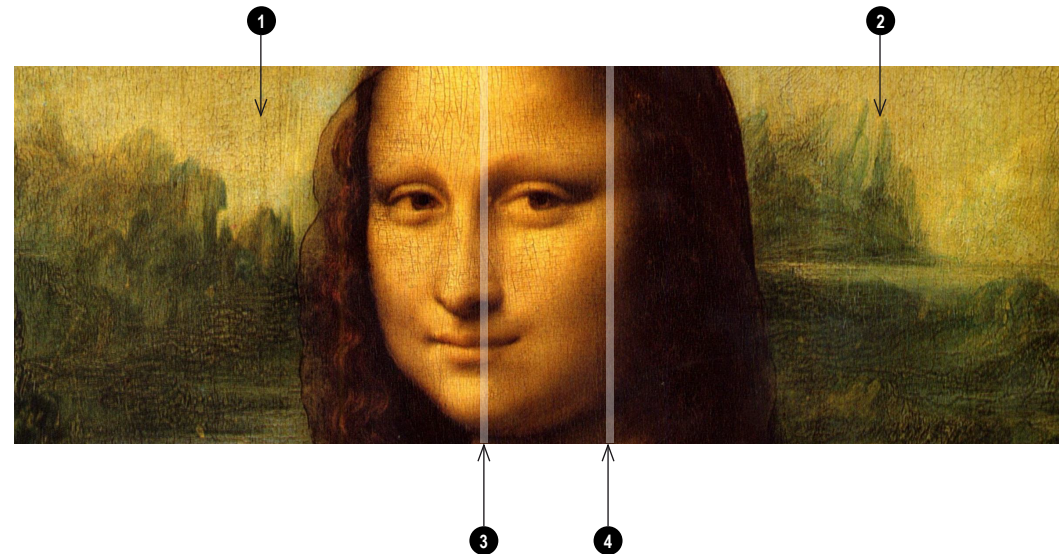

3D

Use this menu to enable, disable and set up 3D input, as follows:

- **3D Format**
Off, Auto, Side-by-side (Half), Top and Bottom, Dual Pipe and Frame Sequential.
Frame Sequential is for sources where Left and Right eye images are delivered as alternate frames from a single input. **Dual Pipe** is for sources where Left and Right eye are delivered on separate inputs.
- **DLP Link**
Off / On.
DLP Link On emits a sync pulse for the 3D glasses via the projected image. **DLP Link Off** will send the sync pulse to the sync out connector to use with an external third party emitter.
- **Eye Swap**
Normal and Reverse.
(set to **Reverse** if the left- and right-eye images are displayed in the wrong order)
- **Dark Time**
0.65 ms, 1.3 ms and 1.95 ms.
Set to reduce the effect of banding and image overlapping when viewed through 3D glasses.

3D Sync

- **Offset.**
Use the **LEFT** and **RIGHT** arrow buttons to compensate for image overlapping (ghosting) when viewed through 3D glasses.
- **Reference**
External and Internal.
Select the source of the 3D sync. Internal is referenced to the incoming video. External is for Frame Sequential 3D sources and is supplied by the graphics card or player.

3D	
3D Format	Auto
DLP Link	Off
Eye Swap	Normal
Dark Time	1.95 ms
3D Sync	
Offset	100
Reference	Internal

Notes

If **3D Format** is set to **Off**, all other 3D settings will be unavailable.

See 3D connections on page 40 for more information about supported 3D formats.

The following settings are not available when 3D is on:
Image >Picture Mode, Dynamic Black, Freeze.
Geometry > Digital Zoom, Overscan.
PIP > all settings.

Also: See 3D types on the facing page and See Some 3D settings explained on page 84

See 3D formats on page 115 for 3D resolutions and frame rates.

3D types

To display a 3D image it is first necessary to select the 3D format of the source:

- **Dual Pipe (LEFT and RIGHT)** The left and right eye images are delivered on two separate HDMI links, which the projector will interleave for 3D display.
- **Frame Sequential** For sequential 3D, an external sync is required to identify left and right frames. If no sync is available from the sequential source, the projector will generate an output sync, but it may then be necessary to manually set the Eye Swap each time the player is started.
- **Frame Packing**
- **Side-By-Side**
- **Top/Bottom**

Dark Time and **Sync Offset** need to be set only once, to optimize the image for the glasses in use.

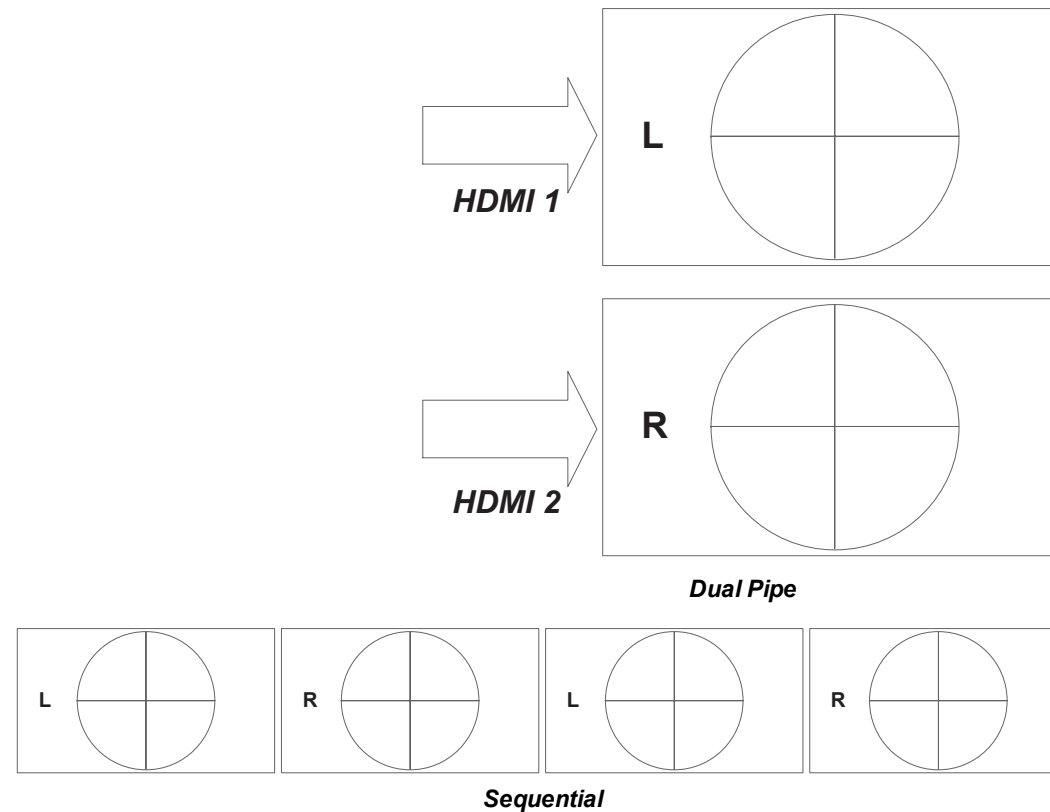

Notes

Some 3D settings explained

Dark Time

Banding can be caused if the image is displayed before each eye of the 3D switching glasses or ZScreen is not fully open. **Dark Time** allows you to minimize this effect.

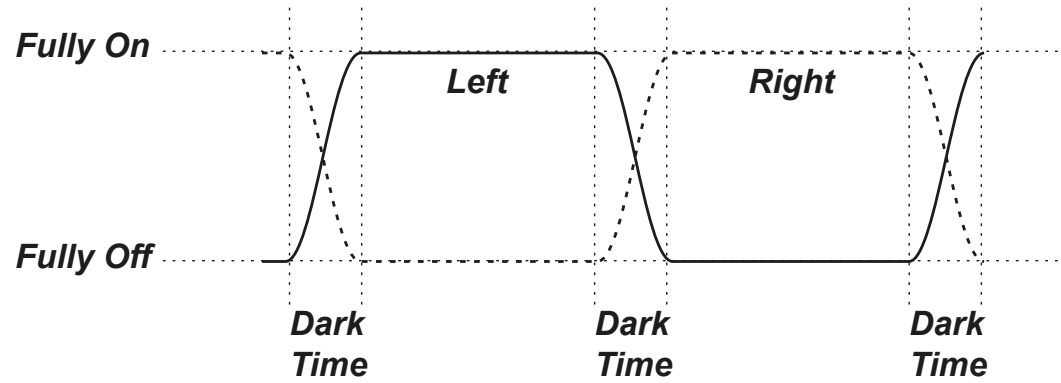

Notes

In order to achieve maximum light output and a smooth grayscale, whilst eliminating ghosting, the following procedure is recommended:



1. Set **Dark Time** to a value appropriate to the glasses or ZScreen, say 1.3 ms or 1.95 ms.
2. Adjust **Sync Offset** time to eliminate ghosting and achieve a smooth grayscale.
3. Repeat steps 1 and 2 until the best result is obtained.

Eye Swap

The outgoing 3D frames are in pairs - the dominant frame being presented first. You can determine which frame should be the dominant one.

By convention the default setting is **Left**.

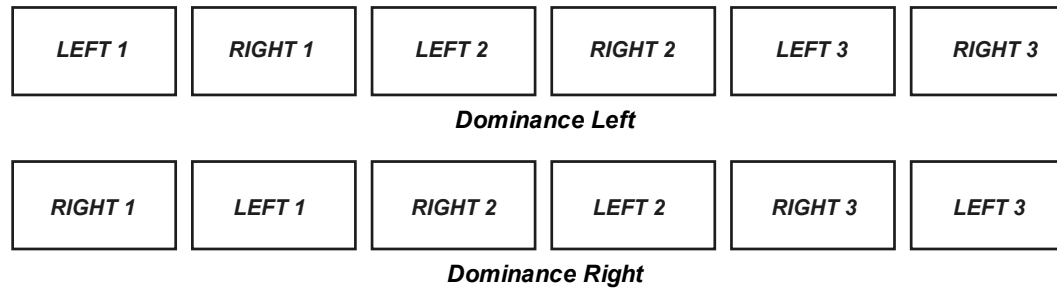

Sync Offset

The sync signal from the 3D server will be in phase with the frames generated by its graphics card. However, to compensate for switching delays in the glasses or ZScreen, **Sync Offset** is used to adjust the sync output signal sent to the ZScreen or 3D glasses to minimise overlapping (ghosting in the image when viewed through the 3D glasses).

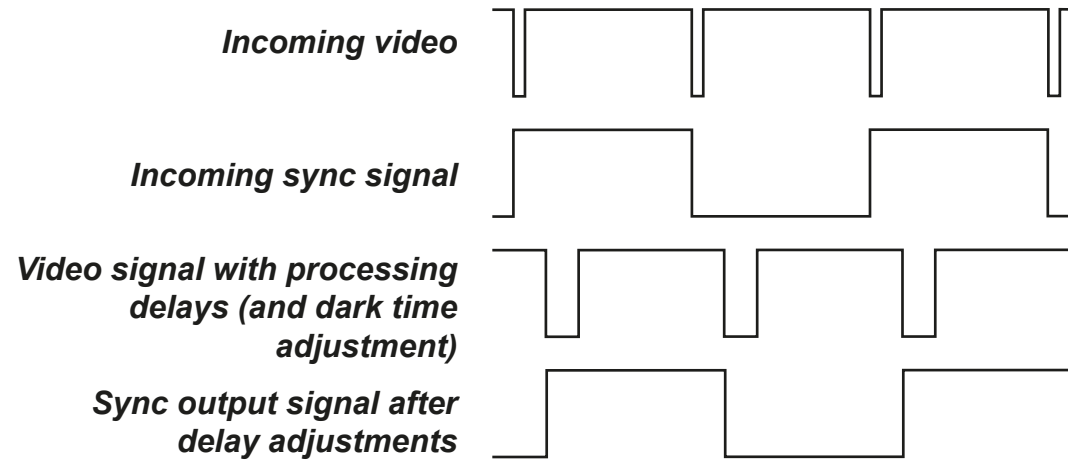
**Notes**

Laser

- **Power Mode**

- **Eco** will automatically set the laser power to 80%.
- **Normal** will set the power to 100%.
- Set to **Custom** if you wish to adjust the power manually.

- **Power Level**

This setting is only available if **Power Mode** is set to **Custom**.
Choose a value between 20 and 100, ranging from 20% to 100% laser power.

- **Constant Brightness**

Once the **Power Mode** has been set to **Custom**, then Constant Brightness can be turned **ON**.
The Constant Brightness setting will maintain the projectors set brightness until the maximum laser power has been reached (this maximum laser power will decrease overtime). Hence, the lower the set Constant Brightness power level the longer the set brightness output will be maintained.

Laser	
Power Mode	Normal
Power Level	-----
Constant Brightness	Off

Notes

Setup

- **Orientation**
Choose from **Front Tabletop**, **Front Ceiling**, **Rear Tabletop**, **Rear Ceiling** and **Auto-front**.
- **High Altitude**
Choose from **On**, **Auto** and **Quiet**.
- **Standby Mode**
Choose from:
ECO uses a low power setting but enables power ON via Ethernet port only.
Normal enables power ON via both HDBase-T/LAN and Ethernet ports.
- **Screen Setting**
Choose from **16:10**, **16:9**, **4:3** and **2.35:1**.
- **ColorMax Setting**
Set up user-defined color gamut values.
- **Power on/off**
Access the submenu to set up automatic projector power on and power off.
- **Clock Adjust**
Access the submenu to set current date and local time.
- **Startup Logo**
Set this to **On** if you want the DP logo to show when the projector is first switched on.
- **Blank Screen**
Choose from **Logo**, **Black**, **Blue** and **White**.
- **Auto Source**
If this setting is **On**, the projector will automatically search for an active input source.

Highlight the **DOWN** arrow at the bottom of the page and press **ENTER/OK** to navigate to the second Setup menu page.

Setup	
Orientation	Auto-front
High Altitude	Auto
Standby Mode	Normal
Screen Setting	16:10
ColorMax Setting	▶
Power on/off	▶
Clock Adjust	▶
Startup Logo	On
Blank Screen	Logo
Auto Source	Off
OSD Settings	▶
	▼

Notes



Auto-front automatically detects the projector's position and sets Table or Ceiling orientation accordingly.

- **Trigger-1 and Trigger-2**

Choose from **Screen, 5:4, 4:3, 16:10, 16:9, 1.88, 2.35, TheaterScope, Source, Unscaled** or **RS232** to determine what will cause each trigger output to activate.

- **Infrared Remote**

Set to **Off** if you wish to disable the remote control.

- **IR Code**

The projector and the remote control need a matching IR code: a two-digit number between **00** and **99**. The default IR code is **00**. This is also a master code, which, if assigned to a remote, will work regardless of the value assigned to the projector.

- **To assign an IR code for the projector:** Select IR code. Use the UP and DOWN arrow buttons to change the values.
- **To assign an IR code for the remote,** press and hold the **ADDR** button on the remote until the On indicator starts flashing. Release the **ADDR** button and while the indicator is still flashing, enter a two digit address using the numeric input buttons. The indicator will flash three times quickly to confirm the change.

- **IR Code Reset**

Use this command to unassign an IR code from the projector. This will revert the **IR Code** value to 00. **To unassign an IR code from the remote control,** press and hold **ALT** and **ADDR** simultaneously until the On indicator flashes to confirm the change.

- **OSD Settings**

Access this submenu to adjust the appearance and position of the on-screen display.

- **Memory**

Access this submenu to save up to four presets containing custom combinations of image settings, or to recall a saved preset.

- **Image Latency**

Select **Fast** for improved latency.

Select **Normal** when image corruption occurs. Image corruption (frame tearing) may occur when a high level of warping is applied to the image and fast latency is selected. See Geometry on page 62 for information about image warping.

- **Electronic Shutter**

Set to **On** to turn the laser off when the PIC Mute activated.

Set to **Off** to project a black image when PIC Mute is activated.

- **EDID Mode**

Access this submenu to set the frame rate and display resolution for each input type.

Highlight the **UP** arrow at the top of the page and press **ENTER/OK** to go back to the first **Setup** menu page.

Setup	
	▲
Trigger-1	Off
Trigger-2	Off
Infrared Remote	On
IR Code	0
IR Code Reset	
OSD Settings	▶
Memory	▶
Electronic Shutter	Enabled
EDID Mode	▶
No Signal Light Off	Off

Notes



The Projector Controller software is available for download from the Digital Projection website, free of charge.

ColorMax

ColorMax permits seven point color matching of red, green, blue, yellow, cyan, magenta and white.

You can enter your own gamut values here, or edit values you have imported using the **Projector Controller** software. You can also set a default color gamut, choose from Peak or REC709.

Defining your own colorspace with individual x and y coordinates for each color enables you to match not only the whites but each individual color as well.

Highlight the submenu you wish to open and press **ENTER/OK** to confirm your choice.

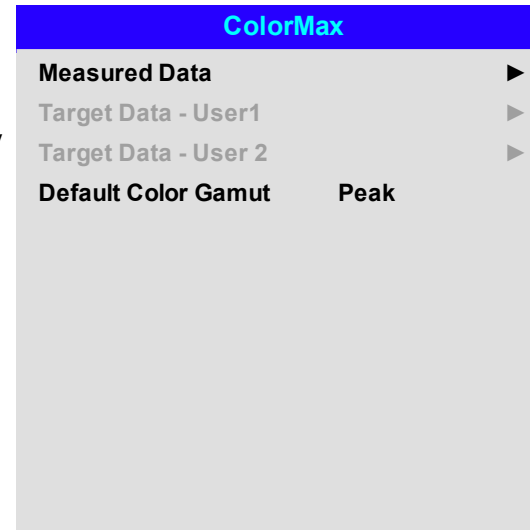

Notes

 *The Projector Controller software is available for download from the Digital Projection website, free of charge.*

 *This tool is best used in conjunction with a specialized light meter (a photo spectrometer) to measure color parameters within a particular installation. However, the preloaded generic factory default data set is designed to give more than satisfactory results.*

Measured data/ target data

1. Use the **UP** and **DOWN** arrow buttons to highlight a color, then use the **LEFT** and **RIGHT** arrow buttons to navigate to the x or y coordinate.
2. Use the **UP** and **DOWN** arrow buttons to increase and decrease the value, respectively.
3. Exit edit mode:
 - press **ENTER/OK**, if you want to save the edited values.
 - press **EXIT**, if you do not wish to save the edited values
4. If necessary, highlight another color and repeat the procedure.

Measured Data	
Red	x: 0.658 y: 0.339
Green	x: 0.315 y: 0.662
Blue	x: 0.146 y: 0.043
White	x: 0.276 y: 0.283
Reset	

Target Data - User1	
Red	x: 0.640 y: 0.390
Green	x: 0.300 y: 0.600
Blue	x: 0.150 y: 0.060
Yellow	x: 0.419 y: 0.505
Cyan	x: 0.225 y: 0.329
Magenta	x: 0.321 y: 0.154
White	x: 0.285 y: 0.302

Power on/off

- **Auto Power Off**

Set this to On if you want the projector to go into STANDBY mode when no input source is detected for 20 minutes.

- **Auto Power On**

Set this to **On** if you want the projector to start up immediately when the mains is connected. Set this to **Off** if you want the projector to go into STANDBY mode when the mains is connected. In this case, the projector will not start up until the **POWER** button is pressed on the control panel or the **ON** button is pressed on the remote control.

- **Scheduled on-off**

Access this submenu to create a weekly schedule for automatic on and off times:

1. Set a schedule:
 - Use the **UP** and **DOWN** arrow buttons to highlight a row, then press **ENTER/OK** to enable edit mode.
 - Within a row, navigate with the **LEFT** and **RIGHT** arrow buttons. Set values with the **UP** and **DOWN** arrow buttons.
 - To exit edit mode, press **ENTER/OK**. Alternatively, press **EXIT** if you don't want the changes to take effect. Move to another row using the **UP** and **DOWN** arrow buttons.
2. To enable the schedule, set Schedule to **On**.

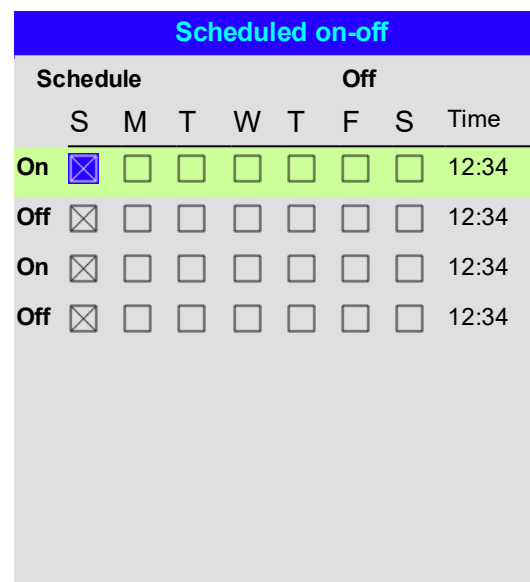
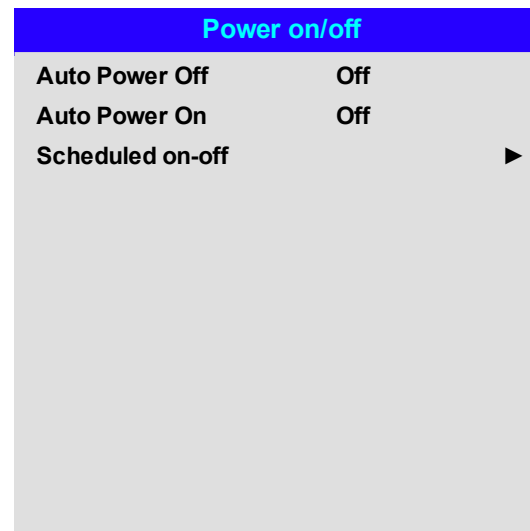

Notes

Clock Adjust

Use this menu to set date (in **dd:MM:yyyy** format), time (in **HH:mm** format) and time zone.

The date and time set here will affect any schedule created within the **Power On/Off** menu.

Clock Adjust	
Date (dd:MM:yyyy)	30:11:2017
Time (HH:mm)	16:00
Time Zone	UTC 00

Notes

OSD Settings

- **Language** sets the OSD language.
- **Menu Position** determines where the OSD should appear on the screen when activated.
- **Menu Transparency** sets OSD transparency between 0% (no transparency), 25%, 50% and 75%.
- **Time Out** determines how long the OSD should remain on screen if no buttons are pressed. Choose Always On to disable this feature.
- **Message Box** determines whether projector status messages should appear on the screen.
- **Menu Rotation** Choose from **Off**, **Clockwise** and **Anticlockwise**. Select a rotation option to rotate the OSD menu when the projector is displaying in portrait.

OSD Settings	
Language	English
Menu Position	Center
Menu Transparency	0
Time Out	30 Seconds
Message Box	On
Menu Rotation	Off

Memory

The current image settings can be saved as a preset, which you can recall later. The default settings can be recalled at any time as well.

Up to four custom presets can be stored for each input.

The following settings are saved in a preset:

- From the **Image** menu — **Dynamic Black, Gamma, Brightness, Contrast, Saturation, Hue, Sharpness, Noise Reduction**
- From the **Color** menu — **Color Space, Color Mode, ColorMax, Color Temperature, Red Lift, Green Lift, Blue Lift, Red Gain, Green Gain, Blue Gain**
- From the **Geometry** menu — **Aspect Ratio, Overscan**

To recall a saved preset:

- Select **Recall Memory** and press **ENTER/OK**, then select a preset from **Preset A** to **Preset D**. Select **Default** to load factory default values.

To save a preset:

- Select **Save Settings** and press **ENTER/OK**, then choose from **Preset A, Preset B, Preset C** and **Preset D**.

EDID Mode

Each signal input type is available in the menu. Select the appropriate frame rate and display resolution for each input.

Memory	
Recall Memory	Default
Save Settings	Preset A

EDID Mode	
HDMI 1	4K/60 HDR
HDMI 2	4K/60 HDR
HDMI 3	1920x1200xp60
HDMI 4	1920x1200xp60
DisplayPort	4K/60
HDBaseT	4K/60

Notes

 Presets from one input cannot be applied to another input.

 See on page 1 for information about the parameters that can be saved in a memory preset.

Network

- **Network Mode**
Choose between **Projector Control** and **Service**.
- **DHCP, IP, Subnet Mask, Gateway, DNS**
Set **DHCP** to **On** if the IP address is to be assigned by a DHCP server, or **Off** if it is to be set here.
If **DHCP** is **On**, it will not be possible to edit IP Address, Subnet Mask, Gateway or DNS.
If **DHCP** is set to **Off**, edit IP Address, Subnet Mask, Gateway and DNS as required.
- **MAC** This field is read-only.
- **AMX (Device Discovery)** Switch on or off

Network	
Network Mode	Projector Control
DHCP	Off
IP	192.168.000.10
Subnet Mask	255.255.255.000
Gateway	000.000.000.000
DNS	000.000.000.000
MAC	00:18:28:2d:f2:06
AMX (Device Discovery)	Off

Notes

PIP

- **PIP**
Turn PIP on and off.
- **Source**
Select an input source for the PIP image. Any combinations are possible between main and PIP input source.
- **Position**
Set the location of the PIP image on the screen. Choose from **Top-Left**, **Top-Right**, **Bottom-Left**, **Bottom-Right** and **PBP**.

PIP	
PIP	Off
Source	HDMI1
Position	Top-Left

Notes

Information

This menu gives information about software and hardware configuration, input source and laser operating times. It also allows you to restore the factory default settings.

Information	
Model Name	M-Vision Laser 23K
Serial Number	X000XXXXX0000
Software Version 1	MD03-SE10-FE09
Software Version 2	STEP_D08-24-17-3120
Software Version 3	2.0.16.0-P503
Active / PIP Source	HDMI 1
Signal Format	▶
Laser Hours	2
System Status	▶
Thermal Status	▶
Factory Reset	

Signal Format

Signal Format	
Active Source	
Timing	1080p/60Hz
H Refresh	67.500 KHz
V Refresh	60.00 Hz
Pixel Clock	148.500 MHz
PIP Source	
Timing	576p/50Hz
H Refresh	31.250 KHz
V Refresh	50.00 Hz
Pixel Clock	27.0 MHz

Notes

System Status

System Status	
Atmospheric Pressure	98988 Pa (116m)
AC Voltage	160V - 264V
Ceiling Mode	0
Tilt Angle	4 deg
Portrait Angle	0 deg
Altitude Mode	Auto
Laser Power	100%
License Key	License Pass, Timeout, Not Expired
Constant Brightness	Off

Notes**Thermal Status**

Thermal Status	
Inlet Temp.	Ti=24 / Ta=34 °C
DMD Temp.	Tc=38 °C
LD 1-2 Temp.	B8=56 / B15=52 °C
Fan 1-4 Speed	1399/1402/1391/1686
Fan 5-8 Speed	1410/1200/1205/1686
Fan 9-12 Speed	1211/1407/1410/1691
Fan 13-16 Speed	1709/3005/3007/2495
Fan 17-20 Speed	2986/2984/4984/4493
Fan 20-23 Speed	3020/3015/2517
Water Pump Speed	3506/3026

Factory Reset

To restore the factory default settings:

1. Navigate to **Factory Reset** and press **ENTER/OK**.
2. When prompted, press **ENTER/OK** to confirm your choice, or press **EXIT** to cancel.

Information	
Model Name	M-Vision Laser 23K
Serial Number	X000XXXXX0000
Software Version 1	MD03-SE10-FE09
Factory Reset	
Warning All user settings will be lost	
Press OK to confirm Press Exit to cancel	
Thermal Status	▶
Factory Reset	OK

Notes



Factory reset does not reset the Network settings, or High Altitude mode

Served web pages

The served web pages allow you to control the projector remotely via LAN.

The default IP address is **192.168.0.100**.

A user name and password is required to access the served web pages for the projector via a web browser.

- The default user name is "admin". This cannot be changed.
- The default password is "admin". This can be changed in the password served web page.



Projector Status
Projector Control
Network Setup
Alert Mail Setup
Date/Time Setup
OSD Function
Password

Change Password

User Name: admin

Password: ●●●●

Password(again): ●●●●

Apply

Notes



We recommend that you change this default password.



If you forget the password, please contact your dealer/integrator for assistance.

DIGITAL  **PROJECTION**

A Delta Associate Company

M-Vision 23000 Series

High Brightness Digital Video Projector

REFERENCE GUIDE



Choosing a lens

A number of lenses are available. Which lens you choose depends on the screen size, image aspect ratio, throw distance and light output.

The following table shows all available lenses in order of their throw ratios:

Throw ratios	Focus range	Lens shift	Part No
0.84 - 1.03 : 1	1.5 m - 10 m	V: 0.37 (U) 0.37 (D) H: 0.12 (L) 0.12 (R)	114-313
1.20 - 1.56 : 1 zoom	1 m - 8 m	V: 0.5 (U) 0.5 (D) frame H: 0.15 (L) 0.15 (R) frame	117-573
1.50 - 2.00 : 1 zoom	2 m - 12 m	V: 0.5 (U) 0.3 (D) frame H: 0.15 (L) 0.15 (R) frame	118-578
2.00 - 4.00 : 1 zoom	2.5 m - 15 m	V: 0.5 (U) 0.3 (D) frame H: 0.15 (L) 0.15 (R) frame	118-588
4.00 - 7.00 : 1 zoom	4 m - 42 m	V: 0.5 (U) 0.3 (D) frame H: 0.15 (L) 0.15 (R) frame	117-463

To choose a lens, calculate the **throw ratio** required. Allow a tolerance of +/- 3% in the throw ratio calculation.

Notes

 *Throw distance calculations are based on the distance from the outer end of the lens, which varies from lens to lens. The lens extension is the distance between the front of the projector chassis and the outer end of the lens when it is fully extended.*

 *Refer to the projector CAD drawings for individual lens extension figures.*

 *The 1.50 - 2.00 : 1 zoom lens has a feature that permits focus correction for curved screens. The front ring of the lens is a manual control that provides focus curvature adjustment to correct for the different focal distances between center and corner.*

 *See Fitting a lens hood on page 29 for more information about using the right lens and hood*

Basic calculation

Identify the required lens by calculating the **throw ratio**.

A **throw ratio** is the ratio of the throw distance **2** to the screen width **1**:

$$\text{ThrowRatio} = \text{ThrowDistance} / \text{ScreenWidth}$$

1. Use the formula above to obtain the required throw ratio.
2. Allow a tolerance of +/- 3% in the throw ratio calculation and match the throw ratio with a lens from the table below:

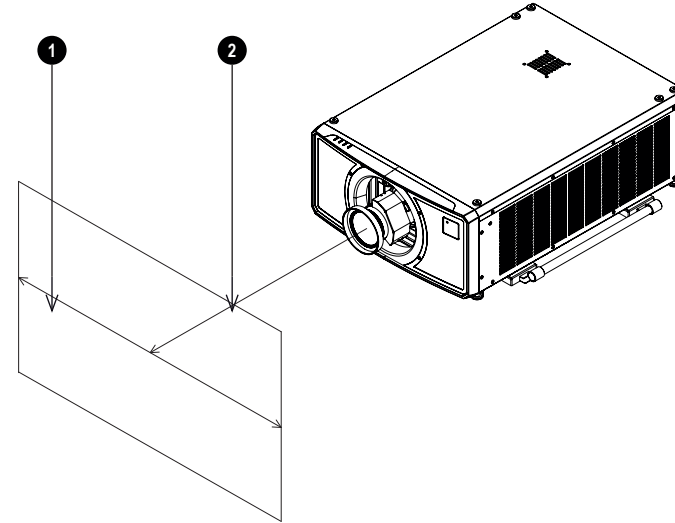

Throw ratios	Focus range
0.84 - 1.03 : 1	1.5 m - 10 m
1.20 - 1.56 : 1 zoom	1 m - 8 m
1.50 - 2.00 : 1 zoom	2 m - 12 m
2.00 - 4.00 : 1 zoom	2.5 m - 15 m
4.00 - 7.00 : 1 zoom	4 m - 42 m

3. Ensure the required throw distance is within the range covered by the lens.

Notes

The basic calculation on this page does not take into consideration DMD™ and image size, which could affect the throw ratio. See Full lens calculation on page 103 for a more complex and realistic calculation.

When calculating the throw ratio, be sure to use identical measurement units for both the throw distance and the screen width.

See Choosing a lens on the previous page for information about individual lens part numbers

See Fitting a lens hood on page 29 for more information about using the right lens and hood

Basic calculation example

1. Calculate the throw ratio using the formula.
Your screen is **4.5m** wide and you wish to place the projector approximately **11m** from the screen. The throw ratio will then be
 $11 \div 4.5 = \mathbf{2.44}$
2. Match the result with the lens table.
The lens matching a throw ratio of 2.44 is the **2.00 - 4.00 : 1 zoom lens**.
3. **Check whether the lens covers the required throw distance.**
The focus range quoted for the 2.00 - 4.00 : 1 zoom lens is **2.5 - 15m**. The required distance of 11m is within the range.

INFORMATION YOU NEED FOR THIS CALCULATION

The throw ratio formula:

$$\mathbf{ThrowRatio = ThrowDistance / ScreenWidth}$$

Allow a tolerance of +/- 3% in the throw ratio calculation.

The lens table:

Throw ratios Focus range

0.84 - 1.03 : 1	1.5 m - 10 m
1.20 - 1.56 : 1 zoom	1 m - 8 m
1.50 - 2.00 : 1 zoom	2 m - 12 m
2.00 - 4.00 : 1 zoom	2.5 m - 15 m
4.00 - 7.00 : 1 zoom	4 m - 42 m

Notes

 The basic calculation on this page does not take into consideration DMD™ and image size, which could affect the throw ratio. See Full lens calculation on the facing page for a more complex and realistic calculation.

 See Choosing a lens on page 100 for information about individual lens part numbers.

Full lens calculation

Introducing TRC

The choice of lens will affect the image size and will address discrepancies between the DMD™ resolution and the source.

When an image fills the height of the DMD™ but not the width, it uses less than 100% of the DMD™ surface. A lens chosen using the basic formula may produce an image that is considerably smaller than the actual screen.

To compensate for loss of screen space in such situations, you need to increase the throw ratio using a **Throw Ratio Correction (TRC)**.

Example

Fig. 1 illustrates a 4:3 image within a 16:9 display

When a 16:9 projector is used for a 4:3 image, the image does not fill the width of the DMD™, creating a **pillarboxing** effect - blank spaces to the left and right.

Fig. 2 shows the same image projected on a 4:3 screen using a standard lens (chosen with the basic calculation).

The DMD™ accurately fills the width of the screen; however, the pillarboxing is now part of the projected image and is transferred to the screen.

The DMD™ does not fill the height of the screen, which has caused **letterboxing** - further blank spaces at the top and bottom of the screen.

The image is now surrounded by blank space, which can be removed if the throw ratio is increased.

Fig. 3 shows the image projected on the same screen with a lens chosen using TRC. The increased throw ratio has allowed the 4:3 image to fill the 4:3 screen seamlessly



Fig 1

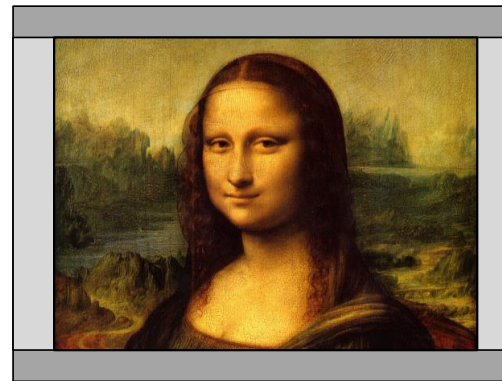



Fig 2



Fig 3

Notes

 TRC can only be applied if greater than 1. If TRC is 1 or less, disregard it and calculate the throw ratio using the basic formula.

Calculating TRC

To calculate TRC, use the following formula:

$$TRC = 1.6(DMD^{\text{TM}} \textit{ AspectRatio}) / \textit{ SourceAspectRatio}.$$

TRC table

Alternatively, you can save time by referencing the following table, which shows the TRC value for some popular image formats:

2.35:1 (Scope)	1920 x 817 pixels	TRC < 1, not used
1.85:1 (Flat)	1920 x 1037 pixels	TRC < 1, not used
1.78:1 (16:9)	1920 x 1080 pixels	TRC < 1, not used
1.6:1 (16:10)	1920 x 1200 pixels	TRC < 1, not used (native aspect ratio)
1.33:1 (4:3)	1596 x 1200 pixels	TRC = 1.2
1.25:1 (5:4)	1500 x 1200 pixels	TRC = 1.28

Calculating the throw ratio with TRC

- For TRC > 1, amend the basic throw ratio formula as follows:

$$\textit{ ThrowRatio} = \textit{ ThrowDistance} / \textit{ ScreenWidth} * \textit{ TRC}$$

Allow a tolerance of +/- 3% in the throw ratio calculation.

- Once a throw ratio is established, identify the matching lens from the table:

Throw ratios	Focus range
0.84 - 1.03 : 1	1.5 m - 10 m
1.20 - 1.56 : 1 zoom	1 m - 8 m
1.50 - 2.00 : 1 zoom	2 m - 12 m
2.00 - 4.00 : 1 zoom	2.5 m - 15 m
4.00 - 7.00 : 1 zoom	4 m - 42 m

- Ensure the required throw distance is within the range of the matching lens.

Notes



TRC can only be applied if greater than 1. If TRC is 1 or less, disregard it and calculate the throw ratio using the basic formula.



TRC can only be applied if greater than 1. If TRC is 1 or less, disregard it and calculate the throw ratio using the basic formula.

Full lens calculation example

Your screen is **4.5m** wide; you wish to place the projector approximately **11m** from the screen. The source is **4:3**.

1. Calculate TRC as follows:
TRC = 1.6 / 1.33 = 1.2.
2. Calculate the throw ratio:
Throw ratio = 11 / 4.5 x 1.2 = **2.04**
3. Allow a tolerance of +/- 3% in the throw ratio calculation and find a match in the lens table.
The table shows that the matching lens is **the 2.00 - 4.00 : 1 zoom lens**.
4. Check whether the lens covers the required throw distance.
The focus range quoted for the 2.00 - 4.00 : 1 zoom lens is **2.5m - 15m**. The required distance of 11 m is within the range.

INFORMATION YOU NEED FOR THESE CALCULATIONS

The TRC formula

$$TRC = DMD^{\text{TM}} \text{ AspectRatio} / \text{SourceAspectRatio}$$

The TRC table (to use instead of the formula)

2.35:1 (Scope)	TRC < 1, not used
1.85:1 (Flat)	TRC < 1, not used
1.78:1 (16:9)	TRC < 1, not used
1.6:1 (16:10)	TRC < 1, not used (native aspect ratio)
1.33:1 (4:3)	TRC = 1.2
1.25:1 (5:4)	TRC = 1.28

The throw ratio formula

$$\text{ThrowRatio} = \text{ThrowDistance} / \text{ScreenWidth} * TRC$$

Allow a tolerance of +/- 3% in the throw ratio calculation.

The lens table:

Throw ratios	Focus range
0.84 - 1.03 : 1	1.5 m - 10 m
1.20 - 1.56 : 1 zoom	1 m - 8 m
1.50 - 2.00 : 1 zoom	2 m - 12 m
2.00 - 4.00 : 1 zoom	2.5 m - 15 m
4.00 - 7.00 : 1 zoom	4 m - 42 m

Notes

Screen requirements

Fitting the image to the display

If the source image supplied to the projector is smaller than the WUXGA resolution, the image will not fill the display. The following examples show how a number of common formats may be displayed, depending on your DMD™ resolution.

WUXGA images displayed full width

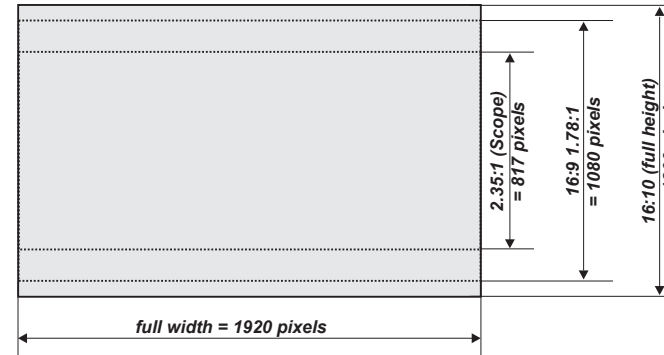

WUXGA images displayed with a height of 2160 pixels

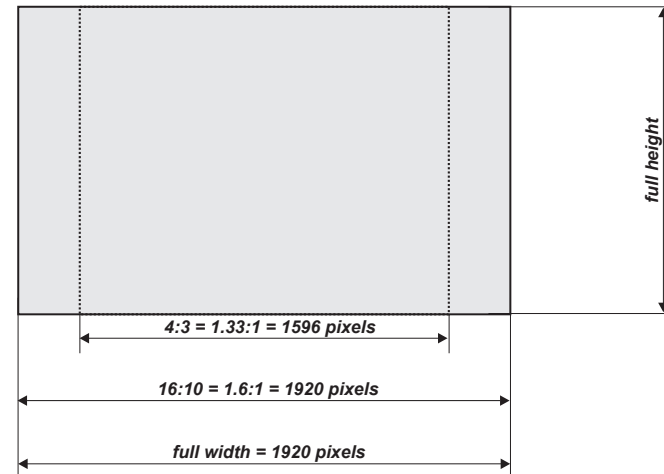

Notes

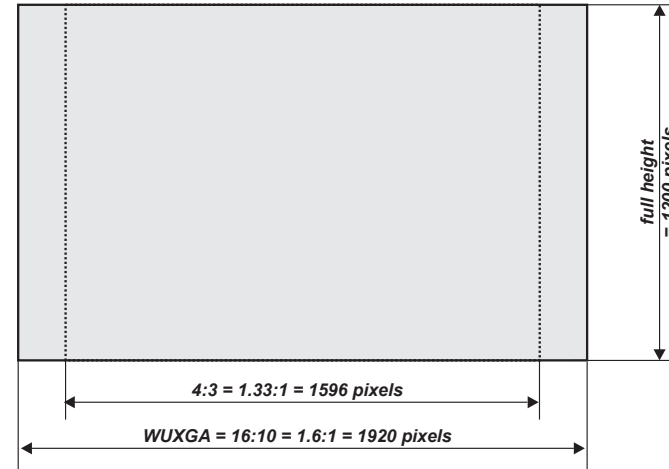
WUXGA images displayed full height**Notes****Diagonal screen sizes**

Screen sizes are sometimes specified by their diagonal size (D). When dealing with large screens and projection distances at different aspect ratios, it is more convenient to measure screen width (W) and height (H).

The example calculations below show how to convert diagonal sizes into width and height, at various aspect ratios.

2.35:1 (Scope)

$$W = D \times 0.92 \quad H = D \times 0.39$$

1.85:1

$$W = D \times 0.88 \quad H = D \times 0.47$$

16:9 = 1.78:1

$$W = D \times 0.87 \quad H = D \times 0.49$$

16:10 = 1.6:1 (native aspect ratio for WUXGA projectors)

$$W = D \times 0.85 \quad H = D \times 0.53$$

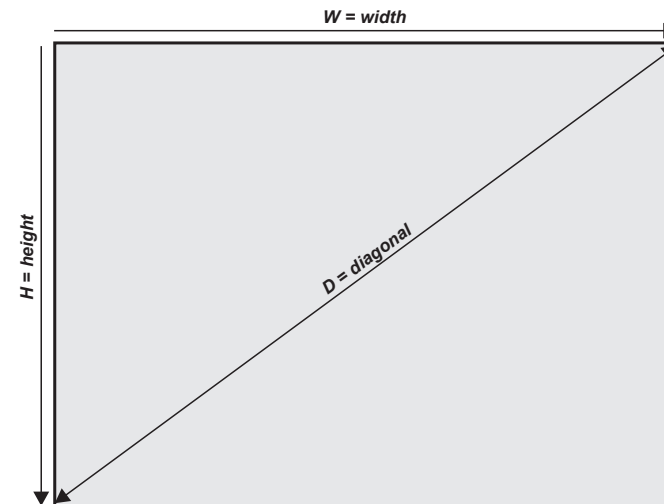

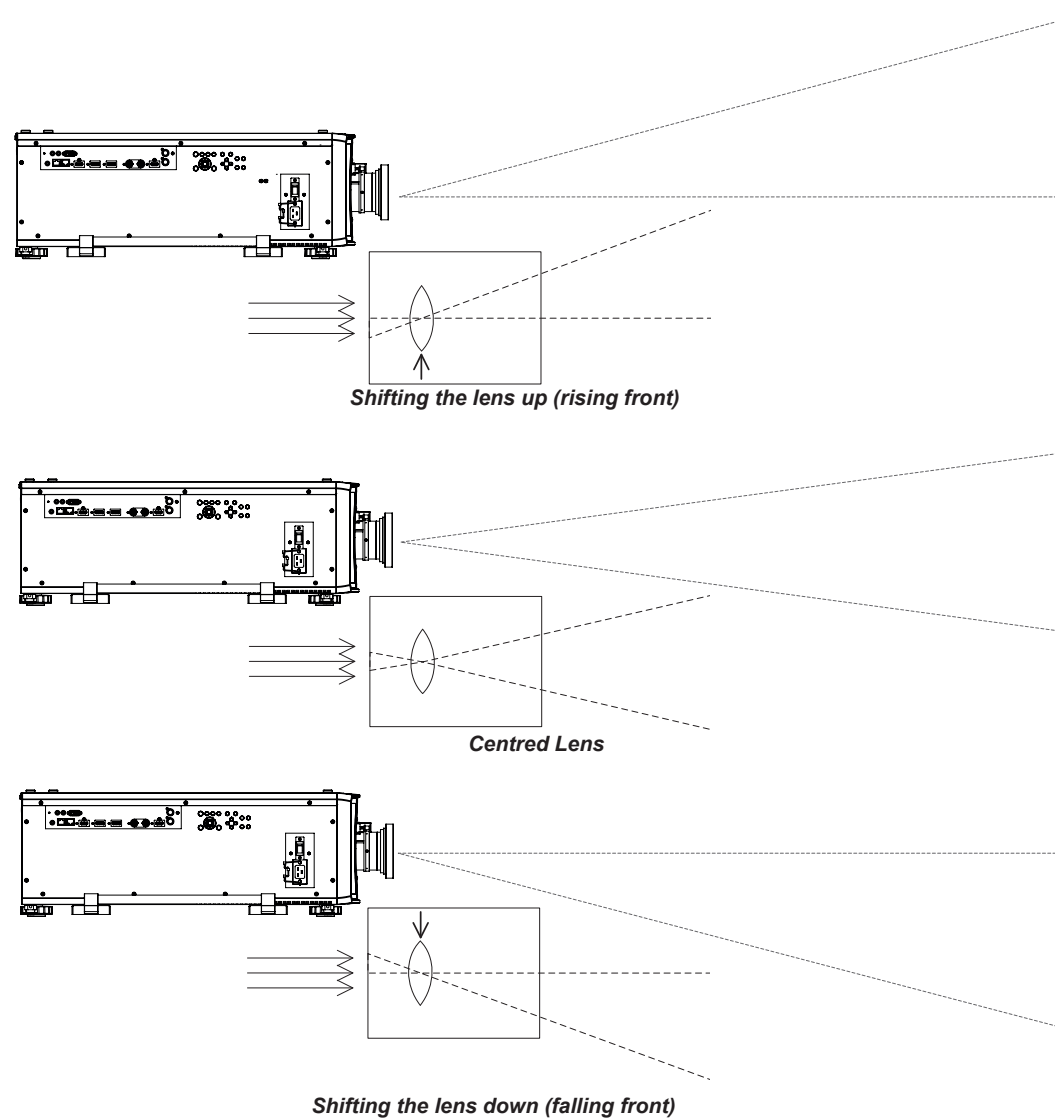

Positioning the image

The normal position for the projector is at the centre of the screen. However, you can set the projector above or below the centre, or to one side, and adjust the image using the **Lens shift** feature (known as **rising and falling front**) to maintain a geometrically correct image.



Notes

 See *Lens control* on page 52 for more information on shifting the lens.

 Whenever possible, position the projector so that the lens is centered for the highest quality image

Any single adjustment outside the ranges specified on the following page may result in an unacceptable level of distortion, particularly at the corners of the image, due to the image passing through the periphery of the lens optics.

If the lens is to be shifted in two directions combined, the maximum range without distortion will be somewhat less, as can be seen in the illustrations.

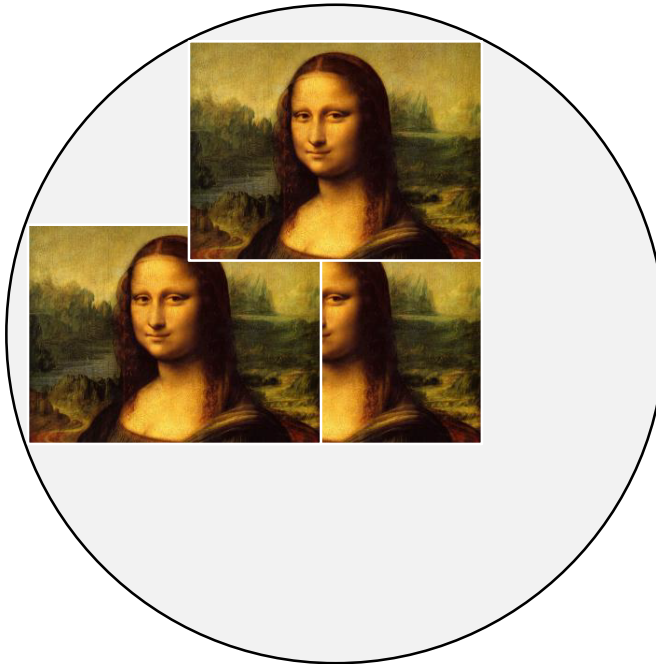

Full horizontal or vertical shift

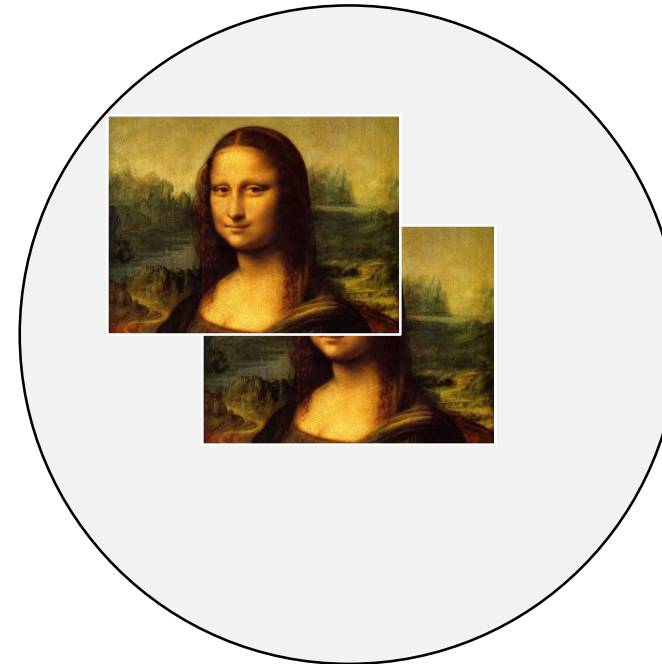

Combined shift is reduced

Notes

Aspect ratios explained

The appearance of a projected image on the screen depends on a combination of the following:

- The display resolution is **WUXGA** with a 1920 x 2160 resolution, corresponding to an aspect ratio of 16:10
- The aspect ratio of the input signal: usually **4:3**, **16:9** or **16:10**
- The value of the **Aspect Ratio** setting of the projector:
 - **16:9**, **4:3**, **16:10** and **5:4** stretch the image to the selected aspect ratio. **16:9** leaves black bars at the top and bottom of the screen (letterboxing effect); **4:3** and **5:4** leave black bars at the sides of the screen (pillarboxing).
 - **TheaterScope** is a special setting used in combination with an anamorphic lens, an optional accessory. It removes letterboxing from a 2.35:1 source packed into a 16:9 frame.
 - **Source** shows the image with its original aspect ratio, if this does not match the native aspect ratio of the DMD™, then the image will be scaled to either fit the full width or height of the display.

Aspect ratios examples

1. Unused screen areas

Source: 4:3

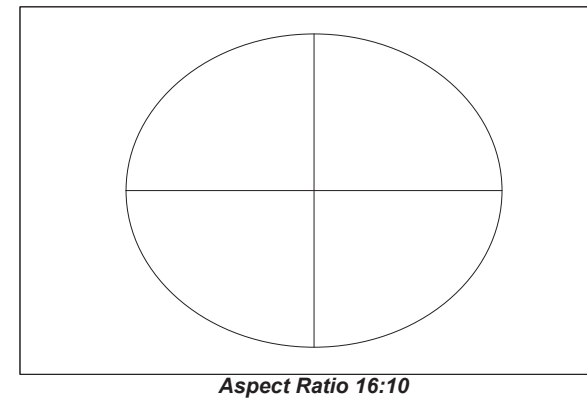
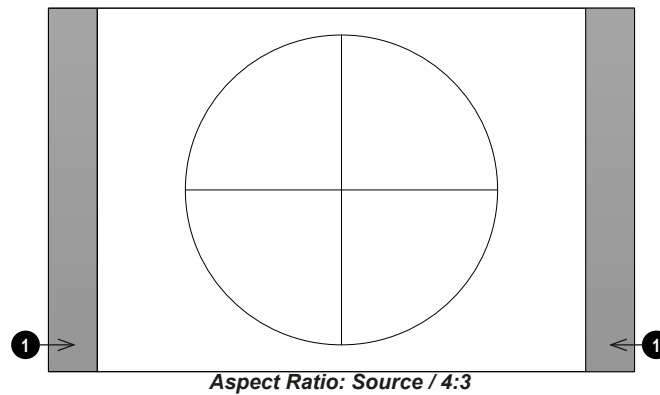

Notes

Source: 16:9

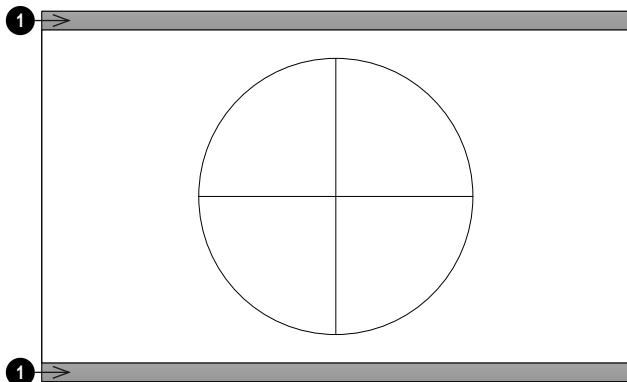

Aspect Ratio: Source / 16:9

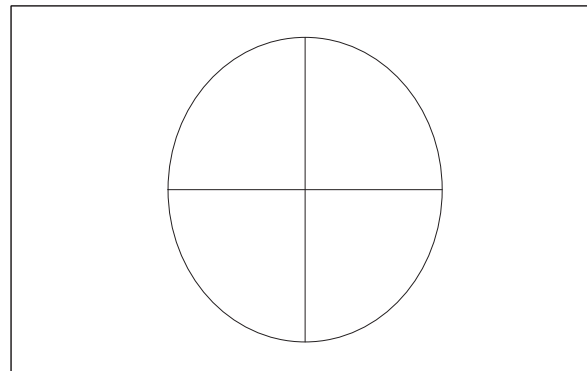

Aspect Ratio 16:10

Source: 16:10 (native)

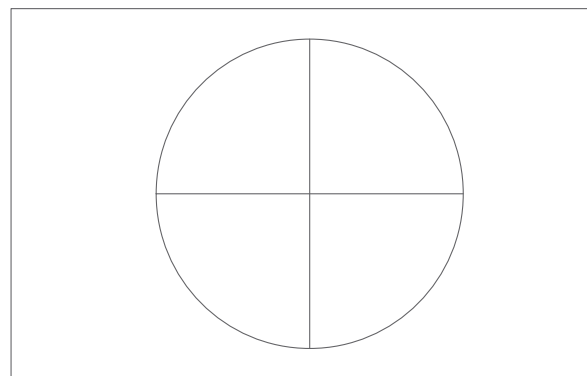

Aspect Ratio: Source / 16:10

Notes

Aspect ratio example: TheatreScope

The TheaterScope setting is used in combination with an anamorphic lens to restore 2.35:1 images packed into a 16:9 frame. Such images are projected with black lines at the top and bottom of the 16:9 screen to make up for the difference in aspect ratios.

Without an anamorphic lens and without the TheaterScope setting applied, a 16:9 source containing a 2.35:1 image looks like this:

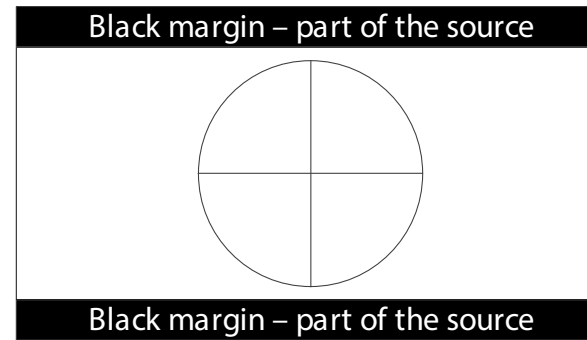

If we change the setting to TheaterScope, the black lines will disappear but the image will stretch vertically to reach the top and bottom of the DMD™:

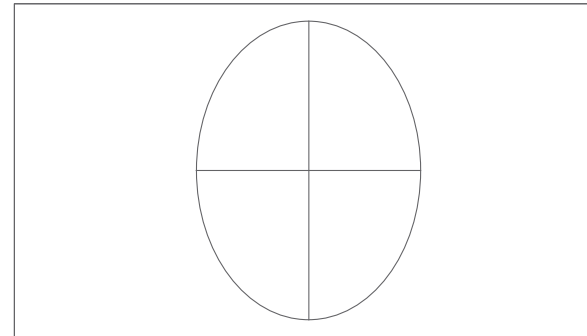

An anamorphic lens will stretch the image horizontally, restoring the original 2.35 ratio:

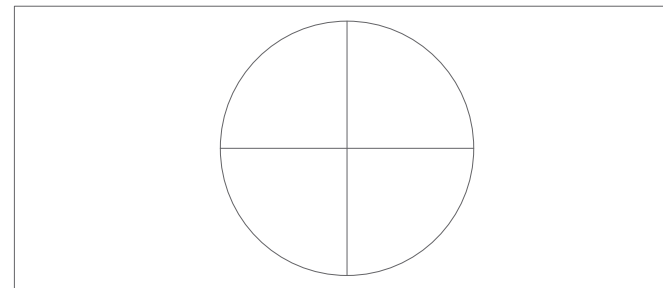

Notes

Appendix A: supported signal input modes

Notes

2D formats

Signal Format	Resolution	H Freq. (kHz)	Frame Rate (Hz)	PCLK (MHz)	Display Port	HDMI / HD-BaseT				HD/SDI/3G	Remarks
						RGB	YUV 8-bit	YUV 10-bit	YUV 12-bit		
PC	640x480	31.469	59.94	25.175	✓	✓					VESA DMT
	640x480	37.500	74.99	31.500	✓	✓					VESA DMT
	640x480	43.269	85	36.000	✓	✓					VESA DMT
	800x600	37.879	60.32	40.000	✓	✓					VESA DMT
	800x600	46.875	75	49.500	✓	✓					VESA DMT
	800x600	53.674	85.06	56.250	✓	✓					VESA DMT
	848x480	23.674	47.95	25.000	✓	✓					VESA CVT
	848x480	31.020	60	33.750	✓	✓					VESA DMT
	1024x768	48.363	60	65.000	✓	✓					VESA DMT
	1024x768	56.476	70.07	75.000	✓	✓					VESA DMT
	1024x768	60.023	75	78.750	✓	✓					VESA DMT
	1024x768	68.677	85	94.500	✓	✓					VESA DMT
	1152x864	67.5	75	108.000							VESA DMT
	1280x720	35.531	47.95	57.987	✓	✓					VESA GTF
	1280 x 768	47.776	60	79.500	✓	✓					VESA DMT
	1280 x 768	60.289	74.89	102.250	✓	✓					VESA DMT
	1280 x 768	68.633	84.84	117.500	✓	✓					VESA DMT
	1280 x 800	49.702	60	83.500	✓	✓					VESA DMT
	1280 x 800	62.795	74.93	106.500	✓	✓					VESA DMT
	1280 x 960	60.000	60	108.000	✓	✓					VESA DMT
	1280 x 960	85.938	85	148.500	✓	✓					VESA DMT
	1280x1024	63.981	60.02	108.000	✓	✓					VESA DMT
	1280x1024	79.976	75.02	135.000	✓	✓					VESA DMT
	1280x1024	91.146	85.02	157.500	✓	✓					VESA DMT
	1366 x 768	47.712	60	85.500	✓	✓					VESA DMT
	1400X1050	65.317	60	121.750	✓	✓					VESA DMT
	1400X1050	82.278	74.87	156.000	✓	✓					VESA DMT
	1440 x 900	55.935	59.89	106.500	✓	✓					VESA DMT
	1440 x 900	70.635	74.98	136.750	✓	✓					VESA DMT
	1600x900	55.92	60	119.000	✓	✓					VESA GTF
	1600x1200	75.000	60	162.000	✓	✓					VESA DMT
	1680x1050	65.290	60	146.250	✓	✓					VESA DMT

Signal Format	Resolution	H Freq. (kHz)	Frame Rate (Hz)	PCLK (MHz)	Display Port	HDMI / HD-BaseT				HD/SDI/3G	Remarks
						RGB	YUV 8-bit	YUV 10-bit	YUV 12-bit		
PC	1920x1080	53.225	47.95	135.403	✓	✓					VESA CVT
	1920x1200 RB	61.816	50	158.250	✓	✓					VESA CVT
	1920x1200 RB	74.038	60	154.000	✓	✓					VESA CVT
	2048x1152 RB	72.000	60	162.000	✓						VESA CVT
	2560x1600 RB	98.713	59.97	268.500	✓						VESA CVT
Apple Mac	640x480		66.59		✓	✓					Apple MAC
	832x624		74.54		✓	✓					Apple MAC
	1024x768	60.241	74.93	80.000	✓	✓					Apple MAC
	1152x870	68.861	75.06	100.000	✓	✓					Apple MAC
SDTV	480i		59.94							✓	
	1440x480i		60			✓	✓	✓	✓		
	1440x576i		50			✓	✓	✓	✓		
	576i		50							✓	
EDTV	480p		59.94		✓	✓	✓	✓	✓		
	576p		50		✓	✓	✓	✓	✓		
HDTV	1035i		60			✓	✓	✓	✓	✓	
	1080i		50		✓	✓	✓	✓	✓	✓	
	1080i		59.94		✓	✓	✓	✓	✓	✓	
	1080i		60		✓	✓	✓	✓	✓	✓	
	720p		50		✓	✓	✓	✓	✓	✓	
	720p		59.94		✓	✓	✓	✓	✓	✓	
	720p		60		✓	✓	✓	✓	✓	✓	
	1080p		23.98		✓	✓	✓	✓	✓	✓	
	1080p		24		✓	✓	✓	✓	✓	✓	
	1080p		25		✓	✓	✓	✓	✓	✓	
	1080p		29.97		✓	✓	✓	✓	✓	✓	
	1080p		30		✓	✓	✓	✓	✓	✓	
	1080p		50		✓	✓	✓	✓	✓	✓	
	1080p		59.94		✓	✓	✓	✓	✓	✓	
1080p		60		✓	✓	✓	✓	✓	✓		
PsF formats	1080sf	27	24	74.250						✓	
	1080sf	28.125	25	74.250						✓	
	1080sf	33.75	30	74.250						✓	
HD-SDI	720p24	18	24	74.250						✓	
	720p25	18.75	25	74.250						✓	
	720p30	22.5	30	74.250						✓	

Notes

3D formats

Standard		Resolution	V-Freq (Hz)	V-Total	H Freq. (kHz)	HDMI 1/2 (*1)	Display Port (*2)	HB Dual-pipe HDMI (*3)	HB DisplayPort (*3)	Remarks	Output Frame Rate (Hz)
720p50	Frame Packing	1280x720	50.00	1470	37.50	✓				*5	100
720p59	Frame Packing	1280x720	59.94	1470	44.96	✓				*5	120
720p60	Frame Packing	1280x720	60.00	1470	45.00	✓				*5	120
720p50	Top-and-Bottom	1280x720	50.00	750	37.50	✓	✓			*5	100
720p59	Top-and-Bottom	1280x720	59.94	750	44.96	✓	✓			*5	120
720p60	Top-and-Bottom	1280x720	60.00	750	45.00	✓	✓			*5	120
1080p23	Frame Packing	1920x1080	23.98	2205	26.97	✓				*6	96
1080p24	Frame Packing	1920x1080	24.00	2205	27.00	✓				*6	96
1080i50	Side-by-Side (Half)	1920x1080	50.00	1125	56.25	✓	✓			*5	100
1080i59	Side-by-Side (Half)	1920x1080	59.94	1125	67.43	✓	✓			*5	120
1080i60	Side-by-Side (Half)	1920x1080	60.00	1125	67.50	✓	✓			*5	120
1080p50	Side-by-Side (Half)	1920x1080	50.00	1125	56.25	✓	✓			*5	100
1080p59	Side-by-Side (Half)	1920x1080	59.94	1125	67.43	✓	✓			*5	120
1080p60	Side-by-Side (Half)	1920x1080	60.00	1125	67.50	✓	✓			*5	120
1080p50	Top-and-Bottom	1920x1080	50.00	1125	56.25	✓	✓			*5	100
1080p59	Top-and-Bottom	1920x1080	59.94	1125	67.43	✓	✓			*5	120
1080p60	Top-and-Bottom	1920x1080	60.00	1125	67.50	✓	✓			*5	100

Notes

Remarks:

*1: Based on IT6802 chip specification

*2: Based on IT6535 chip specification

*3: Disable PIP function in this situation

*4: 8-bit / color

*5: Frame drop at scaler and frame doubling at formatter

*6 Output display frame rate up to 96Hz for 24Hz 3D input



Standard		Resolution	V-Freq (Hz)	V-Total	H Freq. (kHz)	HDMI 1/2 (*1)	Display Port (*2)	HB Dual-pipe HDMI (*3)	HB DisplayPort (*3)	Remarks	Output Frame Rate (Hz)	Notes
1080p50	Frame Sequential	1920x1080	50.00	1125	56.25	✓	✓			*5	100	
1080p59	Frame Sequential	1920x1080	59.94	1125	67.43	✓	✓			*5	120	
1080p60	Frame Sequential	1920x1080	60.00	1125	67.50	✓	✓			*5	120	
1080p100	Frame Sequential	1920x1080	100.00	1125	112.50		✓		✓	*4, *5	100	
1080p120	Frame Sequential	1920x1080	120.00	1125	135.00		✓		✓	*4, *5	120	
WUXGA_100_RB	Frame Sequential	1920x1200	100.00	1258	125.72		✓		✓	*4, *5	100	
WUXGA_120_RB	Frame Sequential	1920x1200	120.00	1271	152.40		✓		✓	*4, *5	120	
1080p23	Dual Pipe	1920x1080	23.98	1125	26.97			✓		*6	96	
1080p24	Dual Pipe	1920x1080	24.00	1125	27.00			✓		*6	96	
1080p25	Dual Pipe	1920x1080	25.00	1125	28.13			✓		*5	100	
1080p30	Dual Pipe	1920x1080	30.00	1125	33.75			✓		*5	120	
1080p50	Dual Pipe	1920x1080	50.00	1125	56.25			✓		*5	100	
1080p59	Dual Pipe	1920x1080	59.94	1125	67.43			✓		*5	120	
1080p60	Dual Pipe	1920x1080	60.00	1125	67.50			✓		*5	120	
WUXGA_60_RB	Dual Pipe	1920x1200	60.00	1235	74.04			✓		*5	120	

Appendix B: wiring details

Signal inputs and outputs

HDMI

19 way type A connector

1. TMDS Data 2+
2. TMDS Data 2 Shield (Ground)
3. TMDS Data 2-
4. TMDS Data 1+
5. TMDS Data 1 Shield (Ground)
6. TMDS Data 1-
7. TMDS Data 0+
8. TMDS Data 0 Shield (Ground)
9. TMDS Data 0-
10. TMDS Clock+
11. TMDS Clock Shield (Ground)
12. TMDS Clock-
13. CEC
14. not connected
15. SCL (DDC Clock)
16. SCA (DDC Data)
17. DDC/CEC Shield (Ground)
18. +5 V Power
19. Hot Plug Detect

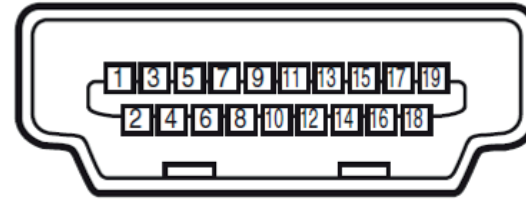

HDMI: pin view of panel connector

Notes

DisplayPort

DisplayPort 1.2

Pin 1	ML_Lane 0 (p)	Lane 0 (positive)
Pin 2	GND	Ground
Pin 3	ML_Lane 0 (n)	Lane 0 (negative)
Pin 4	ML_Lane 1 (p)	Lane 1 (positive)
Pin 5	GND	Ground
Pin 6	ML_Lane 1 (n)	Lane 1 (negative)
Pin 7	ML_Lane 2 (p)	Lane 2 (positive)
Pin 8	GND	Ground
Pin 9	ML_Lane 2 (n)	Lane 2 (negative)
Pin 10	ML_Lane 3 (p)	Lane 3 (positive)
Pin 11	GND	Ground
Pin 12	ML_Lane 3 (n)	Lane 3 (negative)
Pin 13	CONFIG1	Connected to Ground1
Pin 14	CONFIG2	Connected to Ground1
Pin 15	AUX CH (p)	Auxiliary Channel (positive)
Pin 16	GND	Ground
Pin 17	AUX CH (n)	Auxiliary Channel (negative)
Pin 18	Hot Plug	Hot Plug Detect
Pin 19	Return	Return for Power
Pin 20	DP_PWR	Power for connector (3.3 V 500 mA)

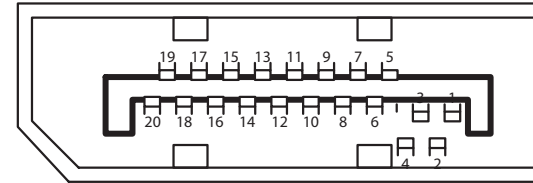
**DisplayPort: pin view of panel connector****Notes**

3G-SDI in, 3G-SDI out

75 ohm BNC

**3G-SDI connector****HDBaseT input**

RJ45 socket.

1. DATA 0+
2. DATA 0-
3. DATA 1+
4. DATA 2+
5. DATA 2-
6. DATA 1-
7. DATA 3+
8. DATA 3-

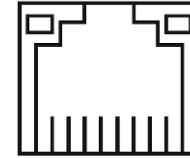

8 7 6 5 4 3 2 1

HDBase-T**Control connections****LAN**

RJ45 socket

1. TX+
2. TX-
3. TXC
4. Ground
5. Ground
6. RXC
7. RX+
8. RX-

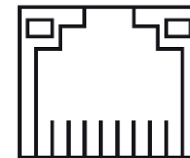

8 7 6 5 4 3 2 1

LAN: pin view of panel connector**Notes**

Only one remote connection
(RS232 or LAN) should be used at
any one time.

RS232

9 way D-type connector

1. not connected
2. Received Data (RX)
3. Transmitted Data (TX)
4. not connected
5. Ground
6. not connected
7. Short with pin8
8. Short with pin7
9. not connected

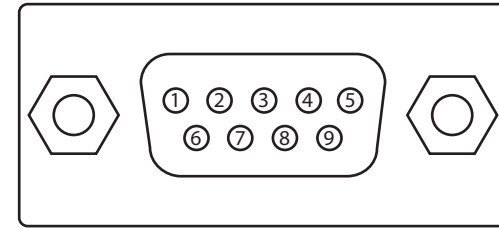

RS232: pin view of panel male connector

Trigger

3.5 mm mini jack, Output: 12V, 200 mA max

- **Tip** Signal
- **Sleeve** Ground

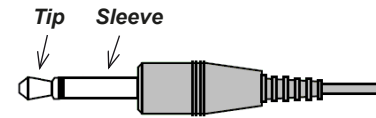

Notes

Appendix C: glossary of terms*Notes***1****1080p**

An HDTV resolution which corresponds to 1920 x 1080 pixels (a widescreen aspect ratio of 16:9).

3**3D active glasses**

Wireless battery-powered glasses with LCD shutters. Synchronization information is communicated to the glasses by means of an infrared (IR) or radio frequency (RF) emitter which is connected to the Sync Out terminal on the projector. IR or RF pulses are transmitted by the emitter to signal when the left eye and right eye images are being displayed. The glasses incorporate a sensor which detects the emitter's signal and synchronises the left and right eye shutters with the projected image.

3D passive glasses

Passive glasses do not require a power source to work. Light with left-hand polarisation can pass through the left lens and light with right hand polarisation can pass through the right-hand lens. These glasses are used in conjunction with another device which polarizes the image, such as a ZScreen.

4**4K-UHD**

The 4K-UHD resolution of 3840 × 2160 is the dominant 4K resolution used in the consumer media and display industries. This resolution has an aspect ratio of 16 :9, with 8,294,400 total pixels.

A**Adjust lines**

A pattern applied to the image where its edge is to be blended with another image. Adjust lines are used to position the projectors in the array during the edge blend process.

Anamorphic lens

A special lens which, when used with the TheaterScope aspect ratio, allows watching 2.35:1 content packed in a 16:9 source.

Aperture

The opening of the lens that determines the angle through which light travels to come into focus.

Aspect ratio

The proportional relationship between the width and the height of the projected image. It is represented by two numbers separated by a colon, indicating the ratio of image width and height respectively: for example, 16:9 or 2.35:1. Not to be confused with resolution.

B**Blanking (projection)**

The ability to intentionally turn off, that is, set to black, areas around the edges of the projected image. It is sometimes referred to as “curtains” since it can be used to blank an area of image that literally falls on the curtains at the side of the screen in a movie theater. Usually no image resizing or geometric correction takes place and the “blanked” part of the image is lost. Not to be confused with horizontal and vertical blanking (video signal).

Blanking (video signal)

The section of the video signal where there is no active video data. Not to be confused with blanking (projection).

Blend region

The area of the image that is to overlap with another image in an edge blend setup. Sometimes called overlapping region.

Brightness (electronic control)

A control which adds a fixed intensity value to every pixel in the display, moving the entire range of displayed intensities up or down, and is used to set the black point in the image (see Contrast). In Component Video signals, brightness is the same as luminance.

Brightness (optical)

Describes how ‘bright’ an image that is projected onto a screen appears to an observer.

C**C**

Also known as ‘C’, this is the component, or pair of components, of a Component Video signal which describes color difference information.

Chrominance

Also known as ‘C’, this is the component, or pair of components, of a Component Video signal which describes color difference information.

Color difference

In Component Video signals, the difference between specified colors and the luminance component. Color difference is zero for monochrome images.

Color gamut

The spectrum of color available to be displayed.

Color temperature

The position along the black body curve on the chromaticity diagram, normally quoted in Kelvin. It takes into account the preset values for color balance in the service set-up to take up the variations in the prism. The projector allows you to adjust this temperature (i.e. adjust the picture color temperature).

Notes

Component video

A three-wire or four-wire video interface that carries the signal split into its basic RGB components or luminance (brightness) and two-color difference signals (YUV) and synchronization signals.

Contrast (electronic control)

The adjustment of the white point of the image without affecting the black point. This increases the intensity range of the displayed image.

Contrast (optical)

The intensity difference between the darkest and lightest areas of the screen.

Cr, Cb

Color difference signals used with 'Y' for digital Component Video inputs. They provide information about the signal color. Not to be confused with Pr, Pb.

Crop

Remove part of the projected image. Alternatively, fit an image into a frame with a different aspect ratio by removing part of the image. The image is resized so that either its length or its width equals the length or width of the frame, while the other dimension has moved outside the frame; the excess area is then cut out.

D**Dark time**

The time inserted between frames when using 3D active glasses, to avoid ghosting caused by switching time between left and right eye.

DDC (Display Data Channel)

A communications link between the source and projector. DDC is used on the HDMI, DVI and VGA inputs. The link is used by the source to read the EDID stored in the projector.

Deinterlacing

The process of converting interlaced video signals into progressive ones.

DHCP (Dynamic Host Configuration Protocol)

A network protocol that is used to configure network devices so that they can communicate on an IP network, for example by allocating an IP address.

DMD™ (Digital Micromirror Device™)

The optical tool that transforms the electronic signal from the input source into an optical image projected on the screen. The DMD™ of a projector has a fixed resolution, which affects the aspect ratio of the projected image. A Digital Micromirror Device™ (DMD™) consists of moving microscopic mirrors. Each mirror, which acts as a pixel, is suspended between two posts by a thin torsion hinge. It can be tilted to produce either a bright or dark pixel.

Notes

E

Edge blend

A method of creating a combined image by blending the adjoining edges of two or more individual images.

Edge tear

An artifact observed in interlaced video where the screen appears to be split horizontally. Edge tears appear when the video feed is out of sync with the refresh rate of the display device.

EDID (Extended Display Identification Data)

Information stored in the projector that can be read by the source. EDID is used on the HDMI, DVI and VGA inputs, allowing the source to automatically configure to the optimum display settings.

EDTV (Enhanced Definition Television)

A progressive digital television system with a lower resolution than HDTV.

F

Field

In interlaced video, a part of the image frame that is scanned separately. A field is a collection of either all the odd lines or all the even lines within the frame.

Frame

One of the many still images displayed in a sequence to create a moving picture. A frame is made of horizontal lines of pixels. For example, a 1920x1080 frame consists of 1080 lines, each containing 1920 pixels. In analog video frames are scanned one at a time (progressive scanning) or split into fields for each field to be scanned separately (interlaced video).

Frame rate

The number of frames shown per second (fps). In TV and video, a frame rate is the rate at which the display device scans the screen to “draw” the frame.

Frame rate multiplication

To stop low frame rate 3D images from flickering, frame rate multiplication can be used, which increases the displayed frame rate by two or three times

G

Gamma

A nonlinear operation used to code and decode luminance. It originates from the Cathode Ray Tube technology used in legacy television sets.

Ghosting

An artifact in 3D image viewing. Ghosting occurs when an image intended for one eye is partially seen by the other eye. Ghosting can be removed by optimizing the dark time and sync delay.

H

HDCP (High-bandwidth Digital Content Protection)

An encryption scheme used to protect video content.

HDTV (High Definition Television)

A television system with a higher resolution than SDTV and EDTV. It can be transmitted in various formats, notably 1080p and 720p.

Hertz (Hz)

Cycles per second.

Horizontal Scan Rate

The rate at which the lines of the incoming signal are refreshed. The rate is set by the horizontal synchronization from the source and measured in Hertz.

Hs + Vs

Horizontal and vertical synchronization.

Hue

The graduation (red/green balance) of color (applicable to NTSC).

I

Interlacing

A method of updating the image. The screen is divided in two fields, one containing every odd horizontal line, the other one containing the even lines. The fields are then alternately updated. In analog TV interlacing was commonly used as a way of doubling the refresh rate without consuming extra bandwidth.

Interleaving

The alternation between left and right eye images when displaying 3D.

L

LED (Light Emitting Diode)

An electronic component that emits light.

Letterboxing

Black margins at the top and bottom of the image. Letterboxing appears when a wider image is packed into a narrower frame without changing the original aspect ratio.

Notes

Lumen

A photometric unit of radiant power. For projectors, it is normally used to specify the total amount of emitted visible light.

Luminance

Also known as 'Y', this is the part of a Component Video signal which affects the brightness, i.e. the black and white part.

N

Noise

Electrical interference displayed on the screen.

NTSC (National Television Standards Committee)

The United States standard for television - 525 lines transmitted at 60 interlaced fields per second

O

OSD (on-screen display)

The projector menus allowing you to adjust various settings.

Overlapping region

The area of the image that is to overlap with another image in an edge blend setup. Sometimes called overlapping region.

P

PAL (Phase Alternate Line)

The television system used in the UK, Australia and other countries - 625 lines transmitted at 50 interlaced fields per second.

Pillarboxing

Black margins at the left and right of the image. Pillarboxing appears when a narrower image is packed into a wider frame without changing the aspect ratio.

Pixel

Short for Picture Element. The most basic unit of an image. Pixels are arranged in lines and columns. Each pixel corresponds to a micromirror within the DMD™; resolutions reflect the number of pixels per line by the number of lines. For example, a 1080p projector contains 1080 lines, each consisting of 1920 pixels.

Pond of mirrors

Area around the periphery of the DMD™ containing inactive mirrors. The pond of mirrors may cause artifacts, for example during the edge blending process.

Notes

Pr, Pb

Color difference signals used with 'Y' for analog Component Video inputs. They provide information about the signal color. Not to be confused with Cr, Cb.

Primary colors

Three colors any two of which cannot be mixed to produce the third. In additive color television systems the primary colors are red, green and blue.

Progressive scanning

A method of updating the image in which the lines of each frame are drawn in a sequence, without interlacing.

Pulldown

The process of converting a 24 fps film footage to a video frame rate (25 fps for PAL/SECAM, 30 fps for NTSC) by adding extra frames. DP projectors automatically carry out reverse pulldown whenever possible.

R**Resolution**

The number of pixels in an image, usually represented by the number of pixels per line and the number of lines (for example, 1920 x 1200).

RGB (Red, Green and Blue)

An uncompressed Component Video standard.

S**Saturation**

The amount of color in an image.

Scope

An aspect ratio of 2.35:1.

SDTV (Standard Definition Television)

An interlaced television system with a lower resolution than HDTV. For PAL and SECAM signals, the resolution is 576i; for NTSC it is 480i.

SECAM (Sequential Color with Memory)

The television system used in France, Russia and some other countries - 625 lines transmitted at 50 interlaced fields per second.

Smooth picture

A feature that can display a higher resolution source than the native resolution of the projector without losing any pixel data.

SX+

A display resolution of 1400 x 1050 pixels with a 4:3 screen aspect ratio. (Shortened from SXGA+, stands for Super Extended Graphics Array Plus.)

Notes

Synchronization

A timing signal used to coordinate an action.

T

Test pattern

A still image specially prepared for testing a projection system. It may contain various combinations of colors, lines and geometric shapes.

TheaterScope

An aspect ratio used in conjunction with a special anamorphic lens to display 2.35:1 images packed into a 16:9 frame.

Throw distance

The distance between the screen and the projector.

Throw ratio

The ratio of the throw distance to the screen width.

TRC (Throw ratio correction)

A special number used in calculating throw distances and throw ratios when the image does not fill the width of the DMD™. TRC is the ratio of the DMD™ aspect ratio to the image source aspect ratio: $TRC = \text{DMD}^{\text{TM}} \text{ aspect ratio} / \text{Source aspect ratio}$ TRC is only used in calculations if it is greater than 1.

U

UXGA

A display resolution of 1600 x 1200 pixels with a 4:3 screen aspect ratio. (Stands for Ultra Extended Graphics Array.)

V

Vertical Scan Rate

The rate at which the frames of the incoming signal are refreshed. The rate is set by the vertical synchronization from the source and measured in Hertz.

Vignetting

Optical cropping of the image caused by the components in the projection lens. This can happen if too much offset is applied when positioning the image using the lens mount.

Vista

An aspect ratio of 1.66:1.

Notes

W

WUXGA

A display resolution of 1920 x 1200 pixels with a 16:10 screen aspect ratio. (Stands for Widescreen Ultra Extended Graphics Array.)

Y

Y

This is the luminance input (brightness) from a Component Video signal.

YUV

Color difference signals used with 'Y' for analog Component Video inputs. They provide information about the signal color. Not to be confused with Cr, Cb.

Z

ZScreen

A special kind of light modulator which polarizes the projected image for 3D viewing. It normally requires that images are projected onto a silver screen. The ZScreen is placed between the projector lens and screen. It changes the polarization of the projected light and switches between left- and right-handed circularly polarized light at the field rate.

Notes

DIGITAL PROJECTION

A Delta Associate Company

Contact Information:

Europe

Digital Projection Limited
Greenside Way, Middleton,
Manchester, M24 1XX, UK
Registered in England No.
2207264
Registered Office: As Above
Tel: (+44) 161 947 3300
Fax: (+44) 161 684 7674
enquiries@digitalprojection.co.uk
service@digitalprojection.co.uk
www.digitalprojection.co.uk

North America

Digital Projection Inc.
55 Chastain Road, Suite 115,
Kennesaw, GA 30144, USA
Tel: (+1) 770 420 1350
Fax: (+1) 770 420 1360
powerinfo@digitalprojection.com
www.digitalprojection.com

China

Digital Projection China
中国北京市朝阳区芍药居北
里101号世奥国际中心A座2301
室(100029)
Rm A2301, ShaoYaoJu 101 North
Lane, Shi Ao International Center,
Chaoyang District, Beijing 100029,
PR CHINA
Tel: (+86) 10 84888566
Fax: (+86) 10 84888566-805
techsupport@dp-china.com.cn
www.dp-china.com.cn

Dubai

Digital Projection FZE
Unit B4, Light Industrial Units 4,
Silicon Oasis, Dubai, UAE
Tel: +971 43300800
enquiries@digitalprojection.co.uk
www.digitalprojection.com

Japan

Digital Projection Japan
〒105-0012 東京都港区芝大門
2-1-14
2-1-14 Shibadaimon, Minato-ku,
Tokyo, Japan 105-0012
japan@digitalprojection.co.uk
www.digitalprojection.com/jp

Taiwan

Digital Projection Taiwan
186 Ruey Kuang Rd, Neihu
District, Taipei, 114 Taiwan
Tel: +886-8797-2088 x8854
Taiwan@digitalprojection.co.uk

Korea

Digital Projection Korea
1511, Byucksan Digital Valley 6-
cha, Gasan-dong, Geumcheon-
gu, Seoul, Korea
Tel: (+82) 2 515 5303 #1417
Korea@digitalprojection.co.uk

India

Digital Projection India
Plot-43, Sector-35, HSIIDC,
Gurgaon Haryana -122001
Tel: +91-124-4874900#4275
india@digitalprojection.co.uk