



User's Guide

Multimedia Projector

EB-PU2010B

EB-PU1007B

EB-PU2010W

EB-PU1007W

EB-PU1008B

EB-PU1006W

EB-PU1008W

Notations Used in This Guide 8

Using the Manual to Search for Information 9

- Searching by Keyword 9
- Jumping Directly from Bookmarks..... 9
- Printing Only the Pages You Need..... 9

Getting the Latest Version of the Documents..... 10

Introduction to Your Projector 11

Projector Parts and Functions 12

- Projector Parts - Front/Top 12
- Projector Parts - Rear..... 13
- Projector Parts - Interface..... 14
- Projector Parts - Base 16
 - Installing the Safety Wire..... 16
- Projector Parts - Control Panel..... 17
- Projector Parts - Remote Control 18
 - Installing Batteries in the Remote Control..... 21
 - Remote Control Operation 21
 - Locking the Remote Control Buttons 22
- Projector Parts - External Camera 23

Setting Up the Projector 24

Notes on Transporting..... 25

Precautions on Installation 26

Attaching and Removing a Lens..... 29

- Attaching a Lens 29
- Removing a Lens 33

Operating the Projector Power 35

- Turning On the Projector 35

- Turning Off the Projector 36

Wired Network Connection..... 37

- Connecting to a Wired Network..... 37
- Selecting Wired Network Settings 37

Wireless Network Connection..... 39

- Installing the Wireless LAN Module 39
- Selecting Wireless Network Settings Manually..... 40
- Selecting Wireless Network Settings in Windows 41
- Selecting Wireless Network Settings in Mac..... 41
- Setting Up Wireless Network Security..... 42
 - Supported Client and CA Certificates 43
- Using a QR Code to Connect a Mobile Device..... 43
- Using a USB Key to Connect a Windows Computer 44

Secure HTTP 46

- Importing a Web Server Certificate Using the Menus..... 46
- Supported Web Server Certificates..... 46

Adjusting the Menu Settings 48

Home Screen..... 49

Using the Projector's Menus 50

Using the Displayed Keyboard 51

- Available Text Using the Displayed Keyboard 51

Using Basic Projector Features 52

- Setting Up the Projector..... 52
 - Messages..... 52
 - Standby Confirmation..... 52
 - Sleep Mode 52
 - Beep 52
 - Indicators 53
 - Date & Time 53
 - Language 53

On-Screen Display	53
Projecting Images.....	53
Source Search.....	53
A/V Mute	54
Freeze	54
Split Screen	54
Volume.....	54
Test Pattern.....	55
Content Playback.....	55
Display Background.....	55
Startup Screen	55
Adjusting the Image Position and Shape	55
Lens Shift	56
Zoom	56
Aspect	56
H/V-Keystone.....	57
Quick Corner.....	57
Curved Surface.....	57
Corner Wall.....	57
Point Correction	58
Screen Type	58
Projection.....	58
Adjusting the Image Quality	58
Focus	58
Color Mode	59
Image Enhancement	59
Gamma	59
RGBCMY.....	60
Brightness Settings	60
Using Multiple Projectors.....	60
Tiling.....	60
Edge Blending.....	60
Black Level.....	61
Scale.....	61
Color Matching.....	61

Maintaining the Projector Quality.....	61
Panel Alignment	61
Color Uniformity.....	62
Refresh Mode	62
Light Source Calibration	62
Managing the Projector's Settings.....	62
Memory	62
Schedule Settings.....	62
Button Lock.....	63
Password Protection.....	64

Copying Menu Settings Between Projectors (Batch Setup) 65

Transferring Settings From a USB Flash Drive.....	65
Transferring Settings From a Computer	66
Batch Setup Error Notification.....	67

Menu Settings 68

Image Menu 69

Color Mode	69
Brightness.....	69
Contrast.....	69
Color Saturation	70
Tint	70
Sharpness	70
White Balance	70
4K Enhancement.....	70
Image Preset Mode.....	71
Frame Interpolation.....	71
Deinterlacing.....	71
Noise Reduction.....	72
MPEG Noise Reduction.....	72
Super-resolution	72
Detail Enhancement.....	72
Reset (Image Enhancement).....	72

Scene Adaptive Gamma	73	Light Source Operation Time	83
Gamma	73	Remote Receiver	84
RGBCMY	73	User Button	84
Dynamic Contrast	73	Test Pattern	84
Lights-Out Control	74	Memory	85
Reset (Image menu)	74	Content Playback	85
Signal Menu	75	Creating Playlists Using Epson Web Control	86
Resolution	75	Content Playback Mode Restrictions	87
Aspect	75	Reset (Settings menu)	87
Tracking	76	Extended Menu	88
Sync.	76	Home Screen	88
Position	76	Menu Position	88
Auto Setup	76	Message Position	89
Overscan	76	Messages	89
Blanking	77	Display Background	89
Color Space	77	Startup Screen	89
Dynamic Range	77	Standby Confirmation	89
Video Range	77	Air Filter Notice	89
EDID	78	Screen	89
Scale	78	Panel Alignment	90
Reset (Signal menu)	78	Color Uniformity	90
Settings Menu	79	OSD Rotation	91
Geometry Correction	79	User's Logo	91
Split Screen	80	Projection	91
Split Screen Projection Restrictions	80	Direct Power On	91
Volume	81	Sleep Mode	92
HDMI Link	81	Sleep Mode Timer	92
Control Panel Lock	81	High Altitude Mode	92
Lens Lock	82	Auto Source Search	92
Light Source Mode	82	Auto Power On	92
Brightness Level	82	Startup Source	92
Constant Brightness	82	Quick Startup	92
Estimated Remains	82	USB Power	93
Constant Brightness Usage Hours	83	A/V Mute Settings	93

Beep.....	93	Projector Name.....	102
Indicators.....	93	PJLink Password.....	102
Log Save Destination.....	93	Remote Password.....	102
Batch Setup Range.....	93	Web Control Password.....	102
AC Voltage Monitoring.....	94	Moderator Password.....	102
Lens Type.....	94	Projector Keyword.....	103
Date & Time.....	94	Display Keyword.....	103
Lens Calibration.....	94	Display LAN Info.....	103
A/V Settings.....	94	Connection Mode.....	103
Standby Mode.....	95	Search Access Point.....	103
HDBaseT.....	95	SSID.....	104
Color Calibration.....	95	Security.....	104
Conditions for Color Calibration.....	95	Passphrase.....	104
Projector ID.....	96	EAP Method.....	104
Projector Grouping.....	96	Channel.....	105
Tiling.....	96	IP Settings.....	105
Edge Blending.....	96	SSID Display.....	106
Black Level.....	97	IP Address Display.....	106
Reset (Multi-Projection menu).....	97	IPv6 Settings.....	106
Screen Matching.....	97	Mail Notification.....	106
Conditions for Screen Matching.....	98	Network Projector E-mail Alert Messages.....	106
Color Matching.....	98	SMTP Server.....	107
Simple Stacking.....	98	Port Number.....	107
Conditions for Simple Stacking.....	99	From.....	107
Schedule Settings.....	99	Address 1 Setting/Address 2 Setting/Address 3 Setting.....	107
Schedule Status Icons.....	100	SNMP.....	107
Language.....	100	Trap IP Address 1/Trap IP Address 2.....	107
Reset (Extended menu).....	100	Community Name.....	107
Network Menu.....	101	PJLink Notification.....	108
Wireless Mode.....	101	Notified IP Address.....	108
Net. Info. - Wireless LAN.....	101	Command Communication.....	108
Net. Info. - Wired LAN.....	102	Secure HTTP.....	108
Display the QR Code.....	102	Web Server Certificate.....	108
Remote Camera Access.....	102	Web API Settings.....	108
		Priority Gateway.....	109

- PJLink..... 109
- AMX Device Discovery 109
- Crestron Connected..... 109
- Art-Net..... 109
- Message Broadcasting 109
- Reset (Network menu) 109

Info Menu..... 110

- Projector Info 110
 - Event ID Code List..... 110
- Light Source Info..... 111
- Version 111
- Status Information..... 111
- Voltage Warning Info 112
- Temp Warning Info 112
- Power On/Off History 112

Reset Menu 113

- Reset All Memories..... 113
- Refresh Mode..... 113
- Light Source Calibration..... 113
- NFC Settings..... 114
- Reset All Config..... 114
- Reset All (Factory Default) 114

Adjusting Projector Features 116

Multi-Projection Features 117

- Procedure Overview 117
- Preparation..... 117
 - Initializing Projectors 117
 - Assigning a Master Projector..... 118
 - Calibrating Projectors..... 118
 - Installing Projectors..... 118
 - Performing Rough Image Adjustments..... 118

- Connecting Projectors to a Network 119
- Image Composition..... 119
 - Tiling..... 119
 - Stacking 120
- Adjusting Colors..... 120

External Camera Usage 122

- Camera Assist Function 122

Monitoring and Controlling the Projector 124

Projector Monitoring and Control Options 125

- Epson Projector Management 125
- Epson Web Control 125
- SNMP 125
- ESC/VP21 Commands 125
- ESC/VP.net Commands..... 126
- PJLink..... 126
- Art-Net..... 126
- Crestron Connected Support 126
- Web API 127

Accessing a Networked Projector Using a Web Browser..... 128

- Web Control Options..... 129

Maintaining the Projector 139

Projector Maintenance 140

Cleaning the Lens..... 141

Cleaning the Projector Case..... 142

Air Filter and Vent Maintenance 143

- Cleaning the Air Filters and Intake Vents 143
- Replacing the Air Filter 145

Solving Problems 148

Projection Problems 149

Projector Indicator Status 150

Projector Status Display Messages 153

Solving Image or Sound Problems..... 157

Solutions When No Image Appears..... 157

Solutions When "No Signal" Message Appears 157

 Displaying From a Windows Laptop..... 158

 Displaying From a Mac Laptop 158

Solutions When "Not Supported" Message Appears 158

Solutions When Only a Partial Image Appears..... 158

Solutions When the Image is not Rectangular 159

Solutions When the Image Contains Noise or Static..... 159

Solutions When the Image is Fuzzy or Blurry 159

Solutions When the Image Brightness or Colors are Incorrect 160

Solutions When Automatic Adjustments are not Applied Correctly 160

Solutions When Simple Stacking is not Applied Correctly 161

Solutions When an Afterimage Remains on the Projected Image 161

Solutions to Sound Problems..... 161

Solving Projector or Remote Control Operation Problems..... 163

Solutions to Projector Power or Shut-Off Problems..... 163

Solutions to Problems with the Remote Control..... 163

Solutions to Password Problems..... 164

Solution When "The Battery that Saves Your Clock Settings is Running Low" Message Appears 164

Solutions to Problems in Content Playback Mode 165

Solving Network Problems 166

Solutions When Wireless Authentication Fails 166

Solutions When You Cannot Access the Projector Through the Web 166

Solutions When Network Alert E-Mails are not Received..... 166

Solutions When the Image Contains Static During Network Projection 167

Solutions When You Cannot Monitor and Control the Projector over a Network 167

Appendix 168

Optional Accessories and Replacement Parts..... 169

Lens 169

Cables 169

Mounts 170

External Devices 170

Replacement Parts..... 170

For Wireless Connection 170

Screen Size and Projection Distance..... 171

Projection Distance 171

Projector Specifications..... 180

Supported Features for Epson Projector Content Manager..... 183

List of Safety Symbols and Instructions 184

Laser Safety Information..... 186

Laser Warning Labels..... 186

Hazard Distance according to IEC62471-5 188

Notices 189

FCC Compliance Statement..... 189

Indication of the manufacturer and the importer in accordance with requirements of EU directive..... 190

Indication of the manufacturer and the importer in accordance with requirements of United Kingdom directive..... 190

Restriction of Use 190

Operating System References..... 190

Trademarks 190

Copyright Notice 191



Copyright Attribution..... 191

Notations Used in This Guide



Safety Symbols

The projector and its manuals use graphical symbols and labels to indicate content that tells you how to use the projector safely.

Read and carefully follow the instructions that are marked with these symbols and labels to avoid injury to persons or damage to property.

 Warning	This symbol indicates information that, if ignored, could possibly result in personal injury or even death.
 Caution	This symbol indicates information that, if ignored, could possibly result in personal injury or physical damage due to incorrect handling.

General Information Notations

Attention	This label indicates procedures that may result in damage or injury if sufficient care is not taken.
	This label indicates additional information that may be useful to know.
[Button name]	Indicates the name of the buttons on the remote control or the control panel. Example: [Esc] button
Menu/Setting name	Indicates projector menu and setting names. Example: Select the Image menu
»»	This label indicates links to the related pages.
	This label indicates the projector's current menu level.

»» Related Links

- "Using the Manual to Search for Information" [p.9](#)
- "Getting the Latest Version of the Documents" [p.10](#)

We assume that this manual will be used by specialists with technical knowledge and experience of projector installation and adjustment.

Make sure you read the *Safety Instructions* before using your projector.

The PDF manual allows you to search for information you are looking for by keyword, or jump directly to specific sections using the bookmarks. You can also print only the pages you need. This section explains how to use a PDF manual that has been opened in Adobe Reader X on your computer.

► Related Links

- "Searching by Keyword" p.9
- "Jumping Directly from Bookmarks" p.9
- "Printing Only the Pages You Need" p.9

- Mac OS: Hold down the command key, and then press ←.

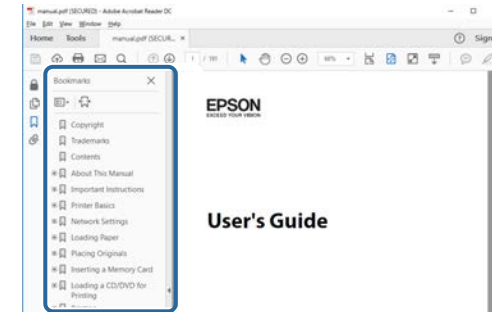

Searching by Keyword

Click **Edit > Advanced Search**. Enter the keyword (text) for information you want to find in the search window, and then click **Search**. Hits are displayed as a list. Click one of the displayed hits to jump to that page.

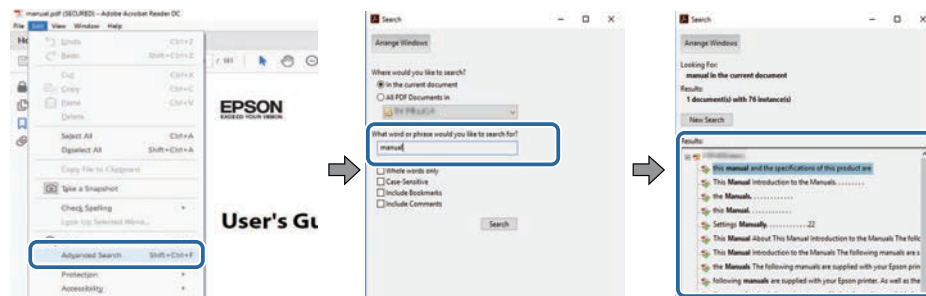

Printing Only the Pages You Need

You can extract and print only the pages you need. Click **Print** in the **File** menu, and then specify the pages you want to print in **Pages in Pages to Print**.

- To specify a series of pages, enter a hyphen between the start page and the end page.
Example: 20-25
- To specify pages that are not in series, divide the pages with commas.
Example: 5, 10, 15

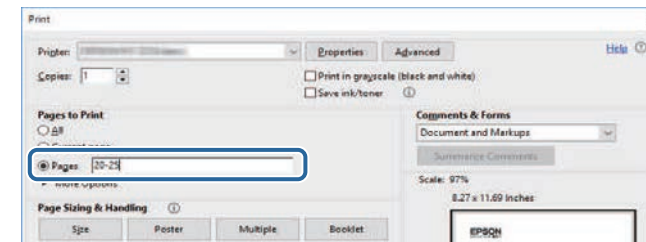

Jumping Directly from Bookmarks

Click a title to jump to that page. Click + or > to view the lower level titles in that section. To return to the previous page, perform the following operation on your keyboard.

- Windows: Hold down **Alt**, and then press ←.

You can get the latest version of the manuals and specifications on the Epson Web site.

Visit epson.sn, and enter your model name.

Introduction to Your Projector

See these sections to learn more about your projector.

► **Related Links**

- "Projector Parts and Functions" [p.12](#)

The following sections explain the projector parts and their functions.

► **Related Links**

- "Projector Parts - Front/Top" [p.12](#)
- "Projector Parts - Rear" [p.13](#)
- "Projector Parts - Interface" [p.14](#)
- "Projector Parts - Base" [p.16](#)
- "Projector Parts - Control Panel" [p.17](#)
- "Projector Parts - Remote Control" [p.18](#)
- "Projector Parts - External Camera" [p.23](#)

Projector Parts - Front/Top

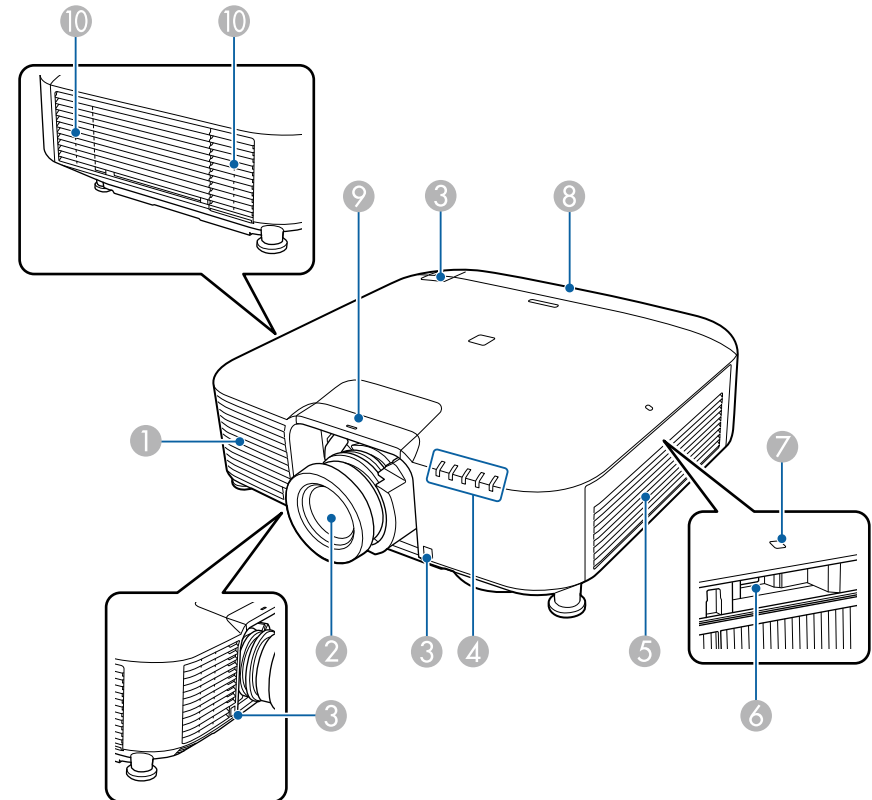

Name		Function
①	Air intake vent	Takes in air to cool the projector internally.
②	Lens	Images are projected from here.

⚠ Warning

Do not look into the projection lens while projecting.

Name	Function
	<p>⚠ Caution</p> <p>Do not place any objects or put your hand near the projection lens. It could cause burns, fire, or the object to warp because this area reaches a high temperature due to the concentrated projection light.</p>
③ Remote receivers	Receive signals from the remote control.
④ Indicator lights	Indicate the projector's status.
⑤ Air intake vent (air filter)	Takes in air to cool the projector internally.
⑥ USB-A port (USB connector Type A)	Use to install the wireless LAN module.
⑦ Wireless LAN indicator	Indicates the access status of the wireless LAN module.
⑧ Cable cover	Cover for the rear interface ports section.
⑨ Lens replacement cover	Remove when attaching or removing the lens. <p>⚠ Caution</p> <p>When moving the projector, do not hold the lens replacement cover. The lens replacement cover may be removed and the projector may fall, which could cause an injury.</p>

Name	Function
⑩ Air exhaust vent	Exhaust vent for air used to cool the projector internally. <p>⚠ Caution</p> <p>While projecting, do not put your face or hands near the air exhaust vent, and do not place objects that may become warped or damaged by heat near the vent. Hot air from the air exhaust vent could cause burns, warping, or accidents to occur.</p>

► **Related Links**

- "Projector Indicator Status" [p.150](#)
- "Installing the Wireless LAN Module" [p.39](#)

Projector Parts - Rear

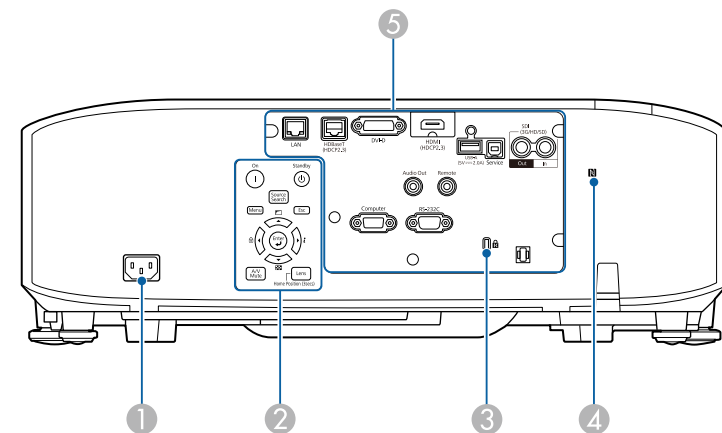

Name	Function
① Power inlet	Connects the power cord to the projector.
② Control panel	Operates the projector.
③ Security slot	The security slot is compatible with the Microsaver Security System manufactured by Kensington.
④ NFC tag	Uses NFC technology to transfer projector information through your mobile device. The Projector Config Tool app lets you scan projector information and write settings.
⑤ Connector ports	Connects interface cables.

Attention

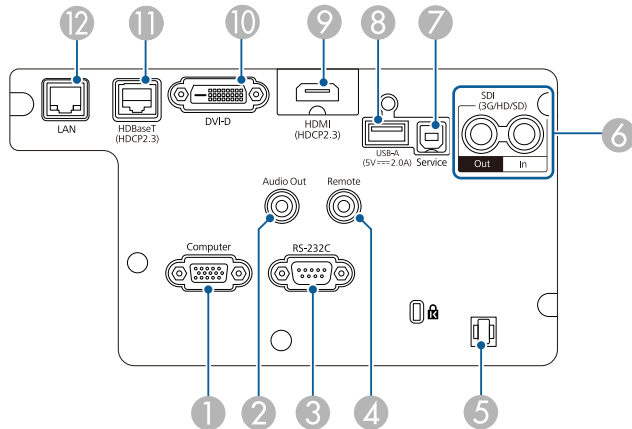

- Check the shape and orientation of the connectors on any cable you plan to connect. Do not force a connector into a port if it does not fit. The device or your projector could be damaged or could malfunction.
- Do not turn on the input source before connecting it to the projector. Doing so could damage the projector.
- If necessary, use an adapter that allows you to connect to an input port on the projector.

Projector Parts - Interface



Name	Function
① Computer port (Mini D-Sub15-pin, female)	Inputs image signals from a computer.
② Audio Out port (Stereo mini pin jack)	Outputs audio from the current input source to an external speaker. You can also connect the projector to an amplifier with speakers. To output audio from external speakers, select Projector as the Audio Out Device setting in the projector's Settings menu. When an audio/video system is not connected to the projector, audio is output from the external speakers even if Audio Out Device is set to AV System . 🔑 Settings > HDMI Link > Audio Out Device If you want to output audio for the HDMI source from the external speakers when the projector is turned off, select Always On as the A/V Output setting in the projector's Extended menu. 🔑 Extended > A/V Settings > A/V Output
③ RS-232C port (Mini D-Sub 9-pin, male)	Use to connect an RS-232C cable to control the projector from a computer.
④ Remote port (Stereo mini pin jack)	Use to connect the optional remote control cable set and inputs signals from the remote control. When the remote control cable is connected, the remote receiver on the projector is disabled.

Name	Function
5 Cable holder	<p>Pass a commercially available cable tie through here to secure cables.</p> <div style="border: 1px solid black; padding: 5px; background-color: #ffffcc;"> <p>Warning</p> <p>Do not bundle the power cord to the other cables. Otherwise, a fire may occur.</p> </div>
6 SDI Out/In ports (BNC)	<p>(EB-PU2010B/EB-PU2010W only)</p> <p>Inputs video signals from SDI compatible video equipment.</p> <p>Outputs video signals input from the SDI In port to an external monitor.</p> <p>You can connect two projectors in a chain using a SDI cable.</p> <p>If you want to output images to an external monitor when the projector is turned off, select Always On as the A/V Output setting in the projector's Extended menu.</p> <p> Extended > A/V Settings > A/V Output</p>
7 Service port (USB connector Type B)	<p>This port is used for batch settings and firmware update.</p>
8 USB-A port (USB connector Type A)	<p>Use to connect a USB memory device for projecting movies or images in Content Playback mode.</p> <p>Use to connect the optional camera.</p> <p>Provides a connection for a streaming media player to power it.</p> <div style="border: 1px solid black; padding: 5px; background-color: #ffffcc;"> <p>Attention</p> <ul style="list-style-type: none"> • Use the USB cable supplied with or specified for use with the device. • Do not connect a USB hub or a USB cable longer than 3 meters, or the device may not operate correctly. </div>

Name	Function
9 HDMI port (HDMI)	<p>Inputs video signals from HDMI compatible video equipment and computers.</p> <p>Connects the optional base unit.</p> <p>This port is compatible with HDCP2.3. (Audio is only supported by PCM)</p>
10 DVI-D port (DVI-D 24-pin single)	<p>Inputs the computer DVI-D signals.</p> <p>This port is compatible with HDCP1.4.</p>
11 HDBaseT port (RJ-45)	<p>Use to connect a LAN cable to the optional HDBaseT Transmitter. You can use a network cable up to 100 m in length. To ensure proper data transmission, use a Category 5e STP cable or better. However, operation is not guaranteed for all input/output devices and environments.</p> <p>This port is compatible with HDCP2.3.</p> <p>Check the following settings:</p> <ul style="list-style-type: none"> • To enable communication from the Ethernet and serial ports on the transmitter, select On as the Control Communications setting in the projector's Extended menu. <ul style="list-style-type: none">  Extended > HDBaseT > Control Communications • If you have connected an Extron XTP transmitter or switcher, select On as the Extron XTP setting in the projector's Extended menu. <ul style="list-style-type: none">  Extended > HDBaseT > Extron XTP
12 LAN port (RJ-45)	<p>Use to connect a LAN cable to connect to a network.</p> <p>Use a 100Base-TX or 10Base-T network cable.</p> <p>To ensure proper data transmission, use a Category 5 shielded cable or better.</p>

Projector Parts - Base

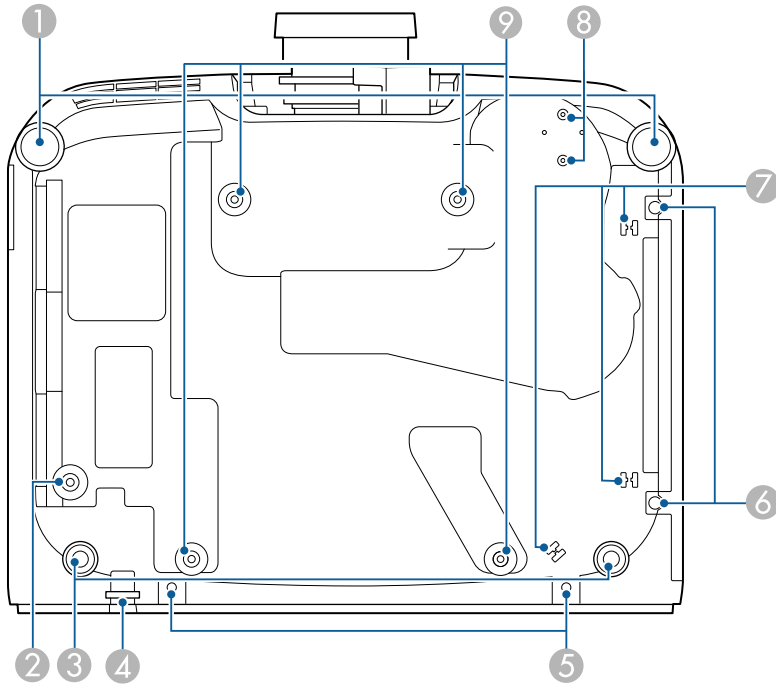

Name	Function
1 Front feet	When the projector is set up on a surface such as a desk, turn to extend the foot to adjust the position of the image. You can adjust the position of the image by tilting the projector up to 10 degrees. The larger the angle of tilt, the harder it becomes to focus.
2 Screw hole (for the ring of the safety wire)	Screw hole for securing the ring of the safety wire to prevent the projector from falling from the ceiling or wall.

Name	Function
3 Rear feet	When the projector is set up on a surface such as a desk, turn to extend and retract the feet to adjust the horizontal tilt. You can adjust the tilt within a range of $\pm 1.5^\circ$. The rear feet are detachable. You can extend the feet by approximately 12 mm before they detach.
4 Security cable attachment point	Pass the theft-prevention wire lock through here and lock it in place. Warning Do not attach the safety wire to this point.
5 Screw holes (for the cable cover)	The screw holes for securing the cable cover. Make sure the cables have been passed through the notch on the base of the cable cover before attaching the cable cover.
6 Air filter cover screws	Screws to fix the air filter cover in place.
7 Cable holder	Pass the cable of the optional external camera through here to secure the cable.
8 External camera fixing points	Use these points to attach the optional external camera.
9 Ceiling mount fixing points (ELPMB67, 4 points)	Use these points to attach the optional ceiling mount when installing the projector on a wall, or mounting the projector from a ceiling.

► Related Links

- "Installing the Safety Wire" [p.16](#)

Installing the Safety Wire

When you use the optional ceiling mount, you can install the safety wire to prevent the projector from falling from the ceiling.

Secure the ring using the M6 × 15 mm bolt supplied with the safety wire set, and loop the safety wire through the ceiling mount to secure it as shown.

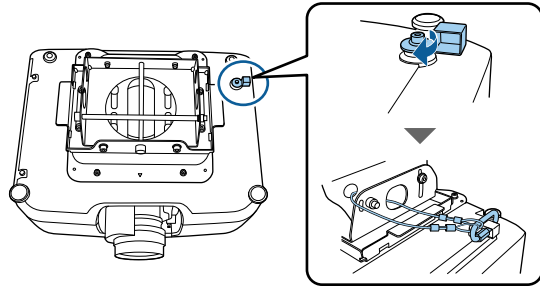

Projector Parts - Control Panel

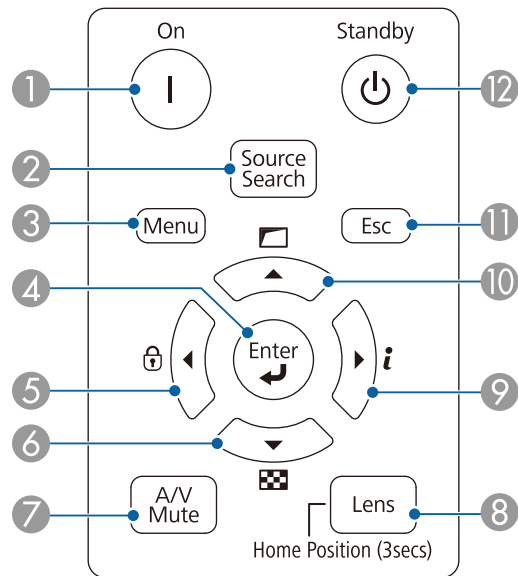

Name	Function
2 [Source Search] button	Changes to the next input source.
3 [Menu] button	Displays and closes the projector's menu.
4 [Enter] button [↵]	Enters the current selection and moves to the next level while displaying the projector's menu. When projecting an analog RGB signal from the Computer port, optimizes the Tracking , Sync. , and Position settings in the projector's Signal menu.
5 Control panel lock button and arrow button	Displays the Control Panel Lock screen allowing you to lock the control panel buttons. Do one of the following to unlock them. <ul style="list-style-type: none"> • Set the Control Panel Lock setting to Off. • Hold down the [Enter] button on the control panel for more than 7 seconds. Selects menu items while displaying the projector's menu.
6 Test pattern button and arrow button	Displays a test pattern. The test pattern's shape is determined by the Screen Type setting. Be sure to set the correct screen type before adjusting with the test pattern. Extended > Display > Screen > Screen Type Selects menu items while displaying the projector's menu.
7 [A/V Mute] button	Turns the video and audio on or off temporarily. The projector's power automatically turns off 2 hours after A/V Mute is enabled. You can disable this feature. Extended > Operation > A/V Mute Settings

Name	Function
1 [On] button	Turns the projector on.

Name	Function
⑧ [Lens] button	Displays the adjustment screens for lens shift, zoom, focus, and distortion in that order each time the button is pressed. Wait 20 minutes after turning on the projector before setting the focus, zoom, and lens shift for maximum accuracy. When adjusting the image position using vertical lens shift, adjust it by moving the image from the bottom to the top. If you adjust it from the top to the bottom, the image position may move down slightly after adjusting. Hold down this button for more than 3 seconds to move the lens position to the home position. Keep the lens position in the home position for the clearest picture.
⑨ Information button [i] and arrow button	Displays the projector's Info menu. Selects menu items while displaying the projector's menu.
⑩ Geometry correction button and arrow button	Corrects the shape of the image using the options in the Geometry Correction setting. Selects menu items while displaying the projector's menu.
⑪ [Esc] button	Stops the current function. Moves back to the previous menu level while displaying the projector's menu.
⑫ [Standby] button	Turns the projector off.

» **Related Links**

- "Geometry Correction" p.79

Projector Parts - Remote Control

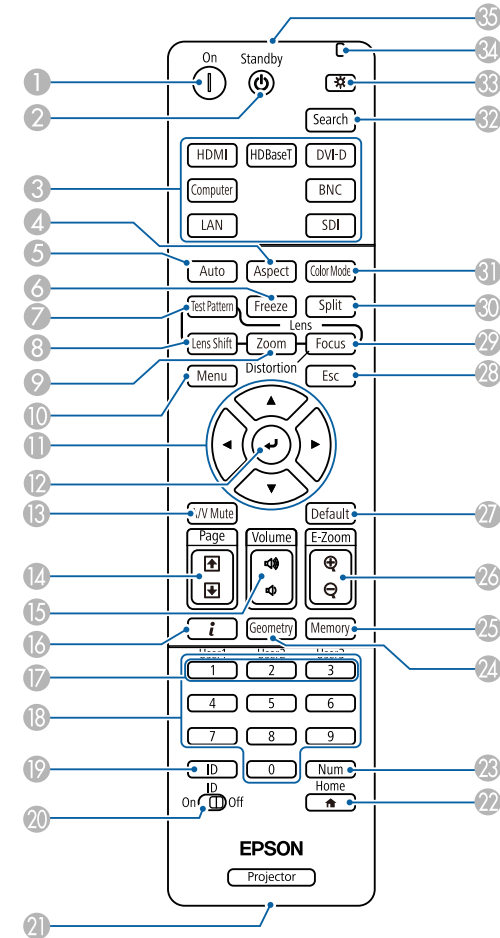

Name	Function
① [On] button	Turns the projector on.
② [Standby] button	Turns the projector off.

Name	Function
③ Switch image source buttons	Switch the image source to each port.
④ [Aspect] button	Changes the aspect mode. You cannot change the aspect mode when the current source is LAN. Note that using the aspect ratio function of the projector to reduce, enlarge, or split the projected image for commercial purposes or for public viewing may infringe upon the rights of the copyright holder of that image based on copyright law.
⑤ [Auto] button	When projecting an analog RGB signal from the Computer port, optimizes the Tracking, Sync., and Position settings in the projector's Signal menu.
⑥ [Freeze] button	Pauses or resumes images. Any sound or video action continues to run, however, so you cannot resume projection at the point that you stopped it. Hold down this button for more than 5 seconds to set up password security.
⑦ [Test Pattern] button	Displays a test pattern. The test pattern's shape is determined by the Screen Type setting. Be sure to set the correct screen type before adjusting with the test pattern. ☛ Extended > Display > Screen > Screen Type
⑧ [Lens Shift] button	Adjusts the position of the projected image. Wait 20 minutes after turning on the projector before setting the focus, zoom, and lens shift for maximum accuracy. When adjusting the image position using vertical lens shift, adjust it by moving the image from the bottom to the top. If you adjust it from the top to the bottom, the image position may move down slightly after adjusting. Hold down this button for more than 3 seconds to move the lens position to the home position. Keep the lens position in the home position for the clearest picture.
⑨ [Zoom] button	Adjusts the image size.

Name	Function
⑩ [Menu] button	Displays and closes the projector's menu. Hold down this button for more than 15 seconds to turn on all remote receivers.
⑪ Arrow buttons	Selects menu items while displaying the projector's menu.
⑫ [Enter] button [↵]	Enters the current selection and moves to the next level while displaying the projector's menu.
⑬ [A/V Mute] button	Turns the video and audio on or off temporarily. The projector's power automatically turns off 2 hours after A/V Mute is enabled. You can disable this feature. ☛ Extended > Operation > A/V Mute Settings Hold down this button for more than 5 seconds to flip the image over top-to-bottom.
⑭ [Page] up/down buttons	Display the previous or next test pattern while displaying a test pattern. Controls page up and down on your computer when you connect a projector and computer using a USB cable or over the network.
⑮ [Volume] up/down buttons	Adjust the speaker volume. <div style="border: 1px solid black; padding: 5px; background-color: #ffffcc;">⚠ Caution Do not start a presentation at a high volume setting. Sudden loud noises may cause hearing loss. Always lower the volume before powering off, so that you can power on and then gradually increase the volume.</div>
⑯ Information button [i]	Displays the projector's Info menu.
⑰ [User] buttons	Perform settings assigned in the User Button setting in the projector's Settings menu.

Name	Function
18 Numeric buttons	Enters numbers in the projector's menu while holding down the [Num] button. In Content Playback mode, enter numbers while holding down the [Num] button to play back your favorite playlists.
19 [ID] button	Press this button and press a number button within 5 seconds to select the ID for the projector you want to operate using the remote control. (Enter a one-digit or two-digit number.) If you do not know the projector's ID, press this button during projection to temporarily display the projector's ID and the remote control's ID on the screen.
20 [ID] switch	Enables (On) or disables (Off) ID settings for the remote control.
21 Remote port	Use to connect the optional remote control cable set and inputs signals from the remote control. When the remote control cable is connected, the remote receiver on the projector is disabled.
22 [Home] button	Displays and closes the Home screen. Hold down this button for more than 5 seconds to lock or unlock the remote control buttons.
23 [Num] button	Hold down this button to enter numbers using the numeric buttons.
24 [Geometry] button	Displays the Geometry Correction screen allowing you to correct keystone distortion of the projected image.
25 [Memory] button	Displays the Memory screen where you can save customized settings and load saved settings. A memory name that has already been used is indicated by a blue mark. Saving over a previously saved memory overwrites the settings with your current settings.
26 [E-Zoom] +/- buttons	Resizes the projected image without changing the projection size. This feature is unavailable if the Scale setting in the projector's menu. ☛ Signal > Scale ☛ Extended > Multi-Projection > Scale

Name	Function
27 [Default] button	Returns the selected setting to its default value. Hold down this button for more than 3 seconds to start the lens calibration process.
28 [Esc] button	Stops the current function. Moves back to the previous menu level while displaying the projector's menu.
29 [Focus] button	Displays the screen where you can adjust the focus and distortion in the projected image.
30 [Split] button	Projects two images from different image sources simultaneously by splitting the projected screen. While using the split screen feature, other projector features may not be available and some settings may be automatically applied to all images. You cannot perform split screen projection when the Content Playback setting is set to On in the projector's Settings menu. Some input source combinations are not supported for split screen projection.
31 [Color Mode] button	Changes the color mode.
32 [Search] button	Switches to the next input source.
33 Illumination button [☀]	Illuminates the buttons on the remote control for approximately 15 seconds. This is useful when using the remote control in the dark.
34 Indicator	A light is emitted when outputting remote control signals.
35 Remote control light emitting area	Outputs remote control signals.

» **Related Links**

- "Installing Batteries in the Remote Control" [p.21](#)
- "Remote Control Operation" [p.21](#)
- "Locking the Remote Control Buttons" [p.22](#)
- "Password Protection" [p.64](#)
- "Home Screen" [p.49](#)

- "Geometry Correction" p.79
- "Memory" p.85
- "Split Screen" p.80

Installing Batteries in the Remote Control

The remote control uses the two AA batteries that came with the projector.

Attention

Make sure you read the *Safety Instructions* before handling the batteries.



Replace the batteries as soon as they run out. The remote control uses two AA manganese or alkaline batteries.

- 1** Remove the battery cover as shown.

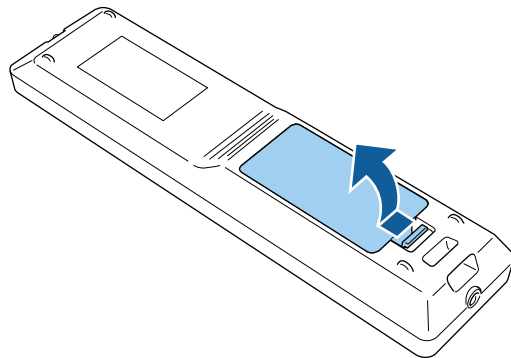

- 2** Remove the old batteries, if necessary.



Dispose of used batteries according to local regulations.

- 3** Insert the batteries.

Warning

Check the positions of the (+) and (-) marks inside the battery holder to ensure the batteries are inserted the correct way. If the batteries are not used correctly, they could explode or leak causing a fire, injury, or damage to the product.

- 4** Replace the battery cover and press it down until it clicks into place.

Remote Control Operation

The remote control lets you control the projector from almost anywhere in the room.

Make sure that you aim the remote control at the projector's receivers within the distance and angles listed here.

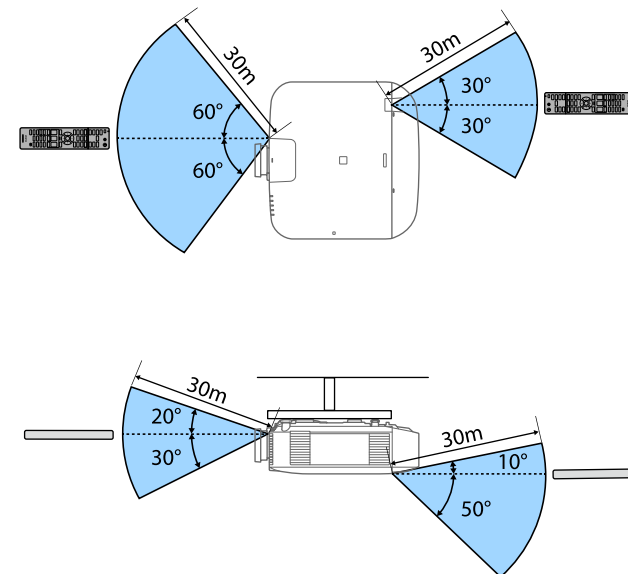



- Depending on your installation environment, the available distance and angles may be shortened.
- Avoid using the remote control in conditions with bright fluorescent lights or in direct sunlight, or the projector may not respond to commands. If you are not going to use the remote control for a long time, remove the batteries.
- When you use multiple projectors in the same room or when there are obstacles around the remote receiver, interference may cause projector operations to become unstable. Connect the optional remote control cable set to the projectors. When the cable set is connected, you can operate projectors stably.

Locking the Remote Control Buttons

You can lock some of the buttons on the remote control.

To lock the remote control buttons shown here, press and hold the [Home] button on the remote control for approximately 5 seconds.

To unlock the buttons, press and hold the [Home] button again for approximately 5 seconds.

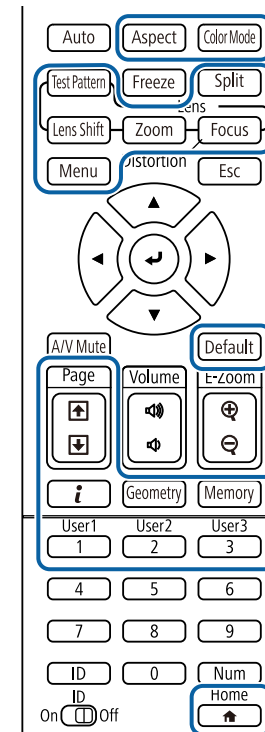

Projector Parts - External Camera

You can attach the optional external camera to the front of the projector or lens. See the external camera manual for the installation method.

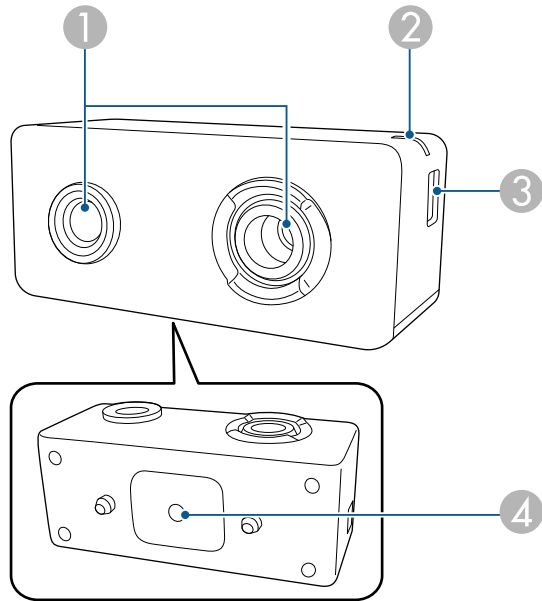

Name	Function
② Indicator light	Indicates the external camera's status. <ul style="list-style-type: none"> • Lit: standby • Flashing (250 ms intervals): external camera is malfunctioning • Flashing (500 ms intervals): external camera is operating • Flashing (1000 ms intervals): updating the firmware
③ micro USB-B port	Connects the supplied USB cable to the projector.
④ Screw holes (for installation)	Secures the mount for installing the external camera.

► Related Links

- "External Camera Usage" [p.122](#)

Name	Function
① Camera lens	Takes photos. <div style="border: 1px solid black; padding: 5px; margin-top: 10px;"> <p>Attention Do not use or store the external camera in places where it will be exposed to strong light. Otherwise, burning or malfunction may occur.</p> </div>

Setting Up the Projector

Follow the instructions in these sections to set up your projector.

► Related Links

- "Notes on Transporting" [p.25](#)
- "Precautions on Installation" [p.26](#)
- "Attaching and Removing a Lens" [p.29](#)
- "Operating the Projector Power" [p.35](#)
- "Wired Network Connection" [p.37](#)
- "Wireless Network Connection" [p.39](#)
- "Secure HTTP" [p.46](#)

There are many glass parts and precision components inside the projector. To prevent damage due to impacts when transporting, handle the projector as follows.

Caution

The projector should not be carried by one person. At least two people are needed to unpack or carry the projector.

Attention

- Remove the lens unit if an option lens is installed.
- If the projector does not have a lens, attach the cover that was on the lens mount when you purchased the projector.

You can install the projector or mount it to the ceiling at any horizontal or vertical angle. Note the following precautions when installing the projector.

Warning

- A special method of installation is required when suspending the projector from a wall or ceiling. If you do not install the projector correctly, it could fall and cause damage or injury.
- Do not use adhesives on the ceiling mount fixing points to prevent the screws from loosening, or use lubricants, oils, or similar substances on the projector; the projector case may crack causing it to fall from its ceiling mount. This could cause serious injury to anyone under the ceiling mount and could damage the projector.
- Do not install the projector in a location subject to high levels of dust or humidity, or in a location subject to smoke or steam. Otherwise, it could cause a fire or electric shock to occur. The projector's case could also deteriorate and be damaged causing the projector to fall from the mount.

Examples of environments that could cause the projector to fall due to case deterioration

- Locations subject to excessive smoke or airborne oil particles, such as factories or kitchens
- Locations containing volatile solvents or chemicals, such as factories or laboratories
- Locations where the projector could be subjected to detergents or chemicals, such as factories or kitchens
- Locations in which aroma oils are often used, such as relaxation rooms
- Near devices that produce excessive smoke, airborne oil particles, or foam at events

Attention

- Use M6 screws (up to a depth of 14 mm) to fix the projector's ceiling mount fixing points and the mounting hardware at four points.

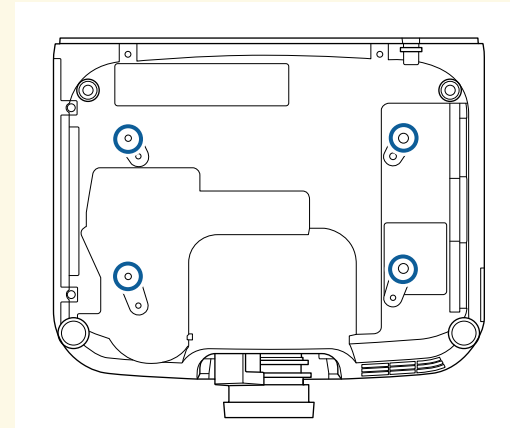

- Do not stack projectors directly on top of each other.

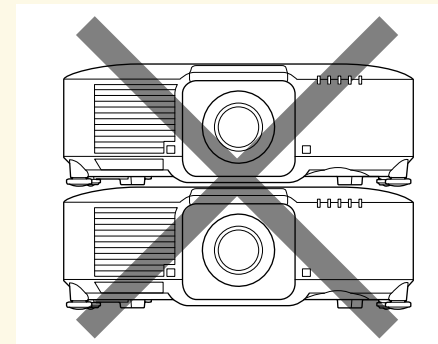

Installation space

Attention

Be sure to leave the following amount of space around the projector so as not to block the air exhaust and intake vents.

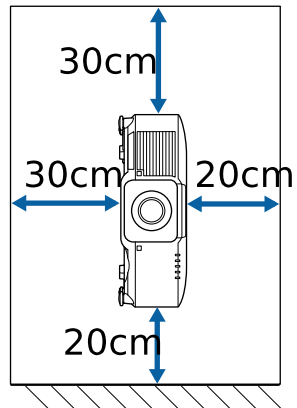
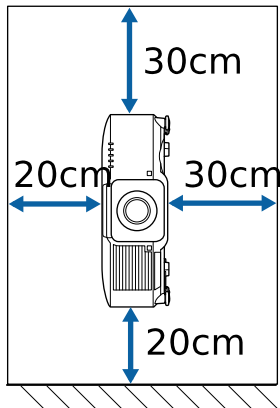
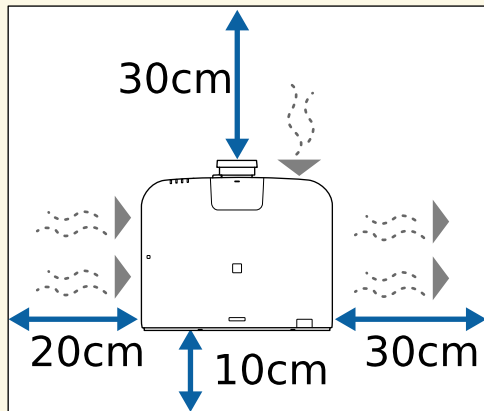

Installation space (When installing multiple projectors side by side)

Attention

- If you are installing multiple projectors next to each other, make sure hot air from the exhaust vent does not go into the air intake vent of another projector.

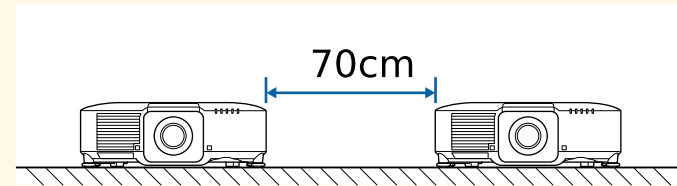

- If you use a partition, you can narrow the space between the projectors.

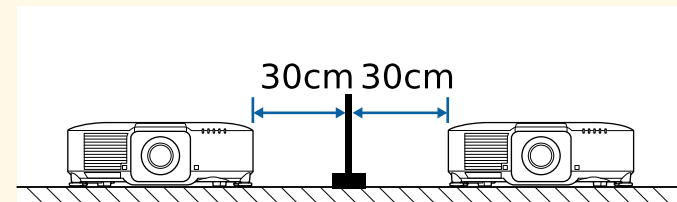

Installation space (When installing the optional external air filter)

Attention

If you are installing the optional external air filter to your projector, be sure to leave the following amount of space around the projector.

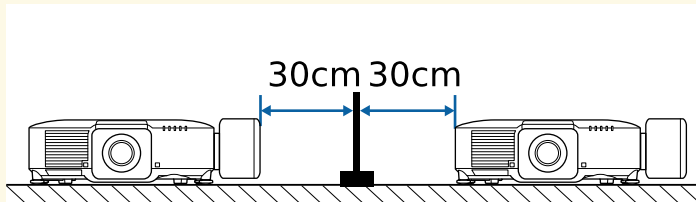
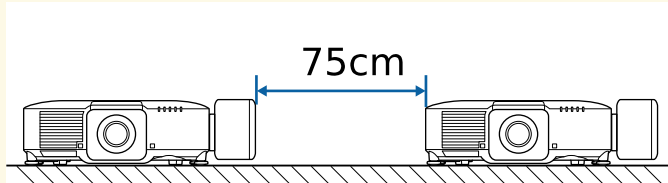
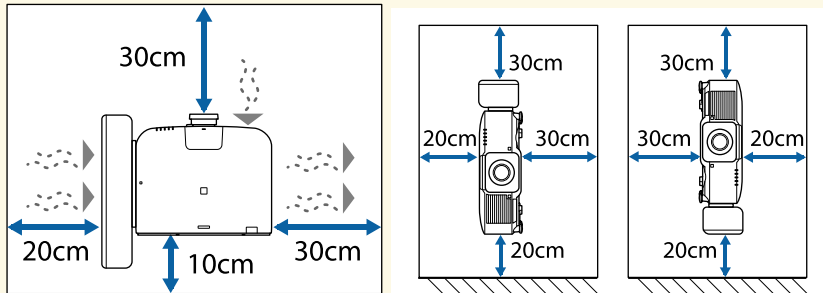

Follow the instructions in these sections to attach or remove a compatible lens.

Warning

Make sure you turn off the projector and unplug the power cord before attaching or removing a lens. Otherwise, you may receive an electric shock.

Attention

- If dust or dirt gets inside the projector, projection quality deteriorates and it could cause a malfunction. Be sure to observe the following precautions when handling.
- Make sure the front of the projector is not facing up when you attach or remove the lens.
- Remove the lens only when necessary.
- Store the projector with the lens installed.
- Avoid touching the lens with your bare hands to prevent fingerprints on or damage to the lens surface.

► Related Links

- "Attaching a Lens" [p.29](#)
- "Removing a Lens" [p.33](#)

Attaching a Lens

You can attach a compatible lens to the projector.



For information on installing an ultra short-throw zoom lens, see the *User's Guide* supplied with the lens.

- 1** Turn off the projector and unplug the power cord.

- 2** Pull the lens cover off of the projector.

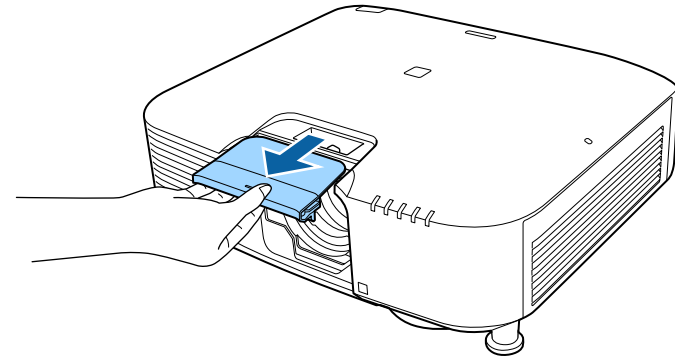

- 3** Remove the stopper, if necessary.

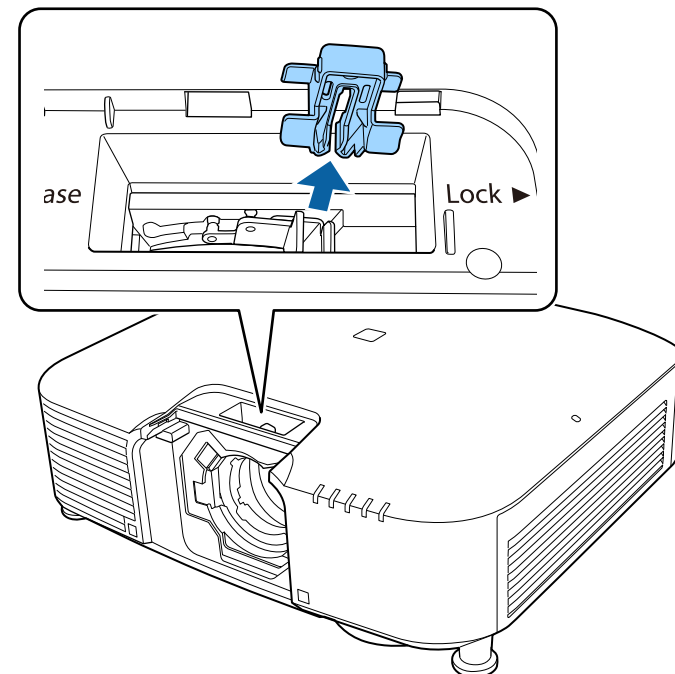

4 Pinch the lock lever and move it to the **Release** position.

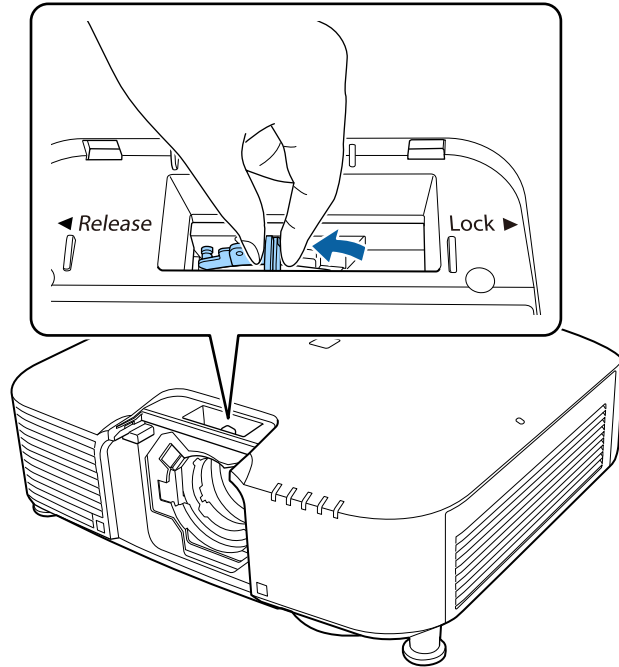

When using one of the following lenses, attach the lens connector cap to protect the port.

- ELPLS04
- ELPLU02
- ELPLR04
- ELPLW04
- ELPLM06/ELPLM07
- ELPLL07

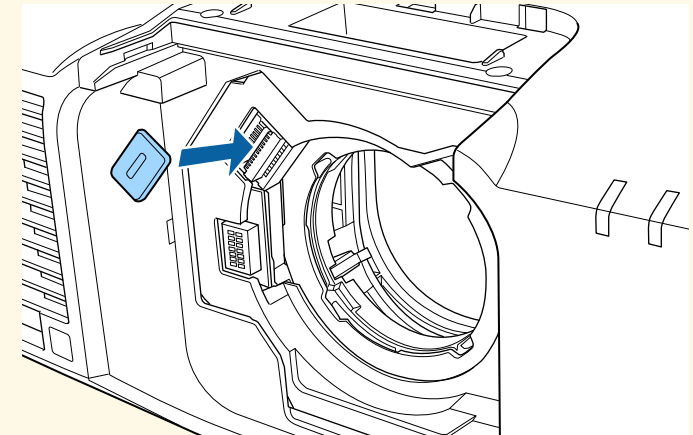

- 5** Insert the lens straight into the projector's lens socket with the white dot facing up.

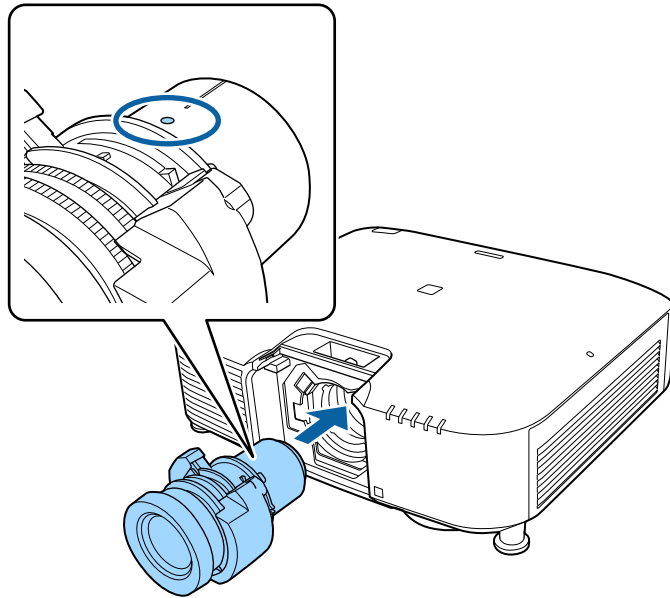

- 6** Hold the lens firmly, then pinch the lock lever and move it to the **Lock** position.

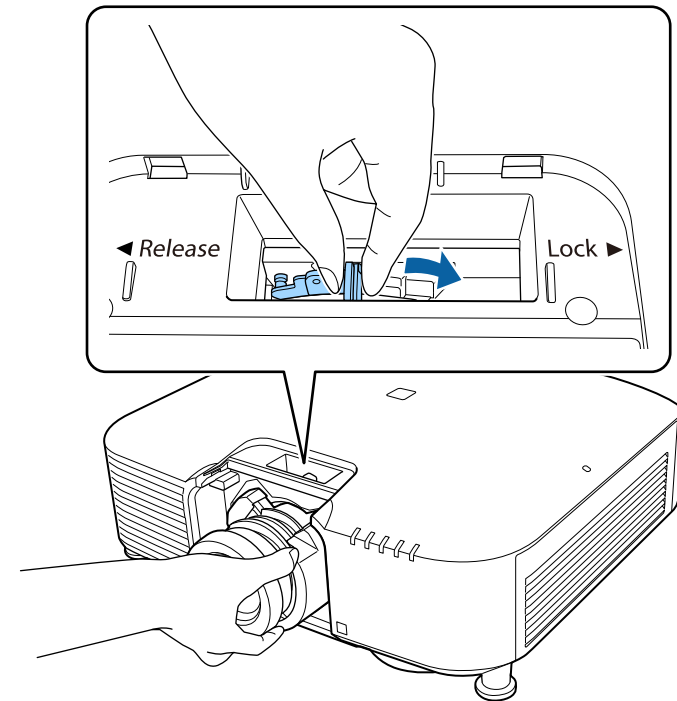

Check that the lens cannot be detached.

7 Reattach the stopper.

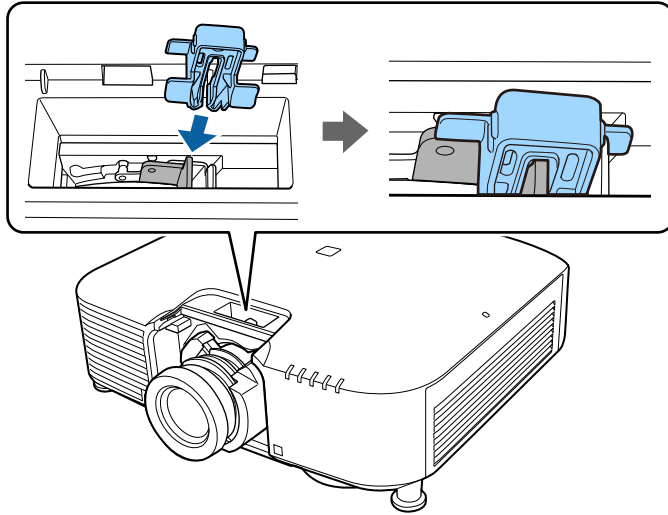

The lever is secured even without using the lever lock, but this adds an additional measure of safety.

8 Replace the lens cover.

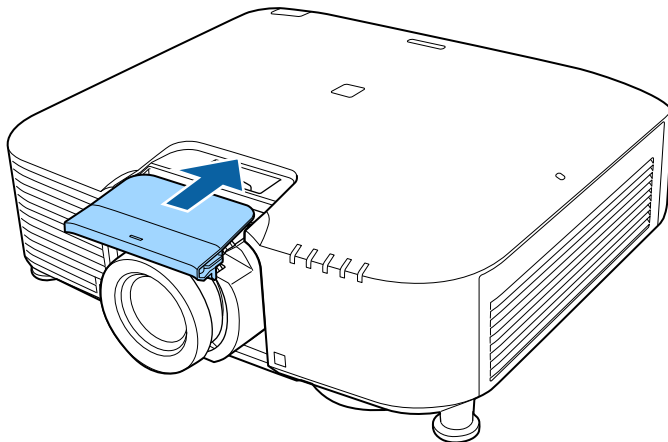

If projecting down, we recommend securing the lens cover with commercially available screws (M3×12mm).

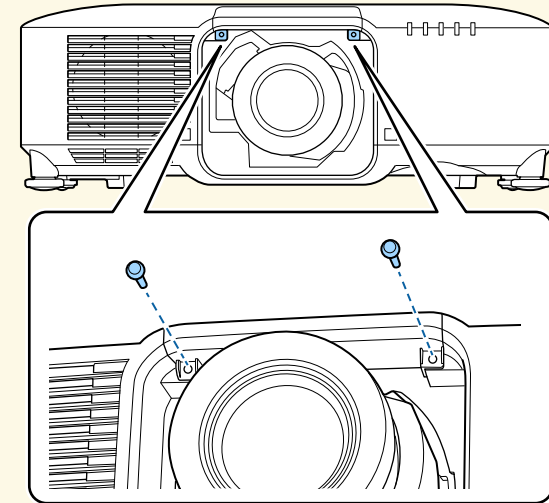

9

If you are prompted when turning on the projector, select **Yes** to calibrate the lens.



- Lens calibration helps the projector to correctly acquire the lens position and adjustment range, and takes up to 100 seconds. When calibration is finished, the lens returns to the same position it was in before calibration.
The following lenses return to the standard position.
 - ELPLX01/01S
 - ELPLX01W/01WS
 - ELPLX02/02S
 - ELPLX02W/02WS
- If no message is displayed after attaching the lens, perform lens calibration using one of the following methods.
 - Hold down the [Default] button on the remote control for approximately 3 seconds.
 - Change the projector's menu:
 - ☛ **Extended > Operation > Lens Calibration**
- If you do not calibrate the lens, the following functions may not operate correctly.
 - Focus
 - Distortion
 - Zoom
 - Lens Shift
 - Memory (Lens Position)

Attention

If the icon indicating that lens calibration has failed is displayed, remove the lens and then reinstall it. If the message continues to be displayed, stop using the projector, remove the power plug from the electrical outlet, and contact Epson for help.

10 When using one of the following lenses, select the **Lens Type** in the projector's menu according to the lens you are using so that distortion correction is performed correctly.

- ELPLS04
- ELPLU02
- ELPLR04

- ELPLW04
- ELPLM06/ELPLM07
- ELPLL07

☛ **Extended > Operation > Advanced > Lens Type**



If you are projecting from a table or other flat surface, the image may be tilted depending on your lens. Adjust the tilt of the image using the front and rear feet.

Removing a Lens

You can remove a lens to replace it with a different lens.



Caution

Wait at least 30 minutes to remove or replace the lens after turning off the projector. Touching the lens unit before it cools down may cause burns.



The projector uses a laser as the light source. As a safety measure, the light source turns off when the lens is removed. Attach the lens, and then press the [On] button to turn it back on.

- 1** Hold down the [Lens Shift] (remote control) or [Lens] (control panel) button for approximately 3 seconds to move the lens to the home position.
- 2** Turn off the projector and unplug the power cord.

3 Pull the lens cover off of the projector.

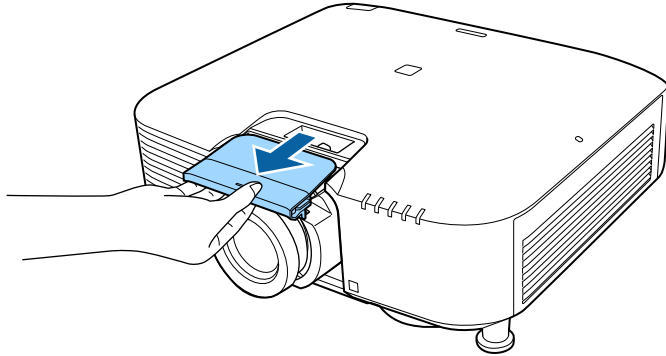

4 Remove the stopper, if necessary.

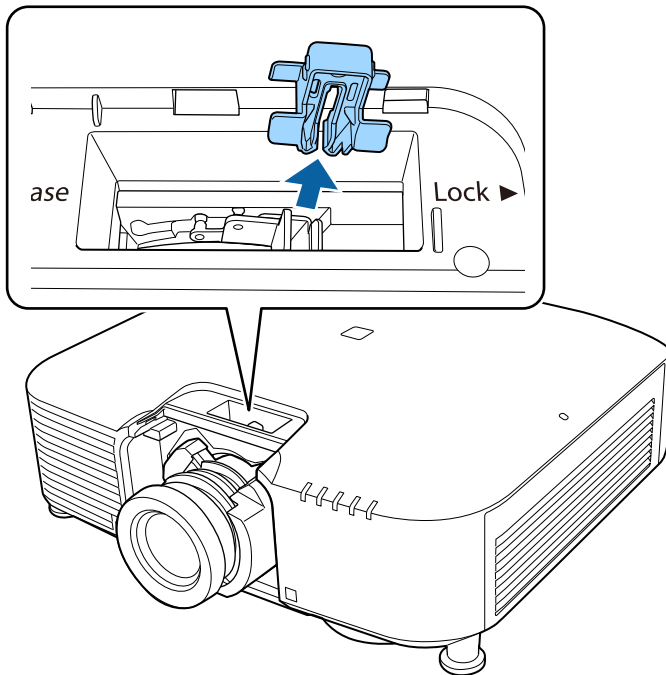

5 Hold the lens firmly as you pinch the lock lever and move it to the **Release** position.

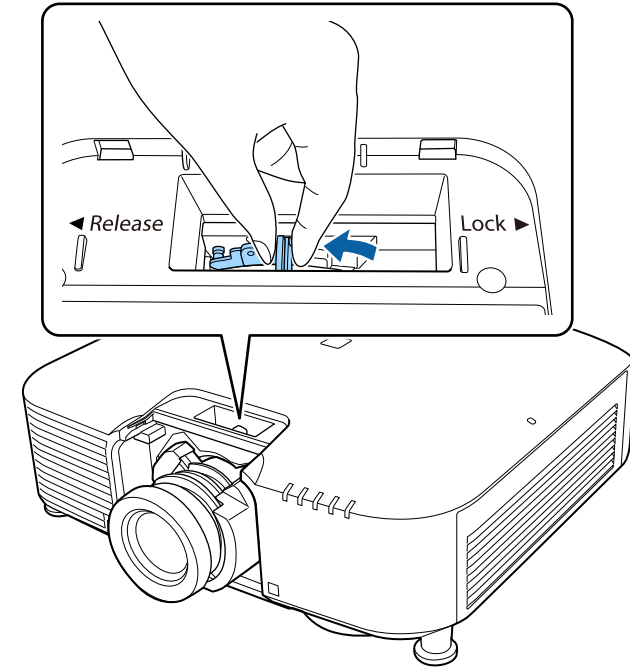

6 Gently pull the lens straight out of the projector.

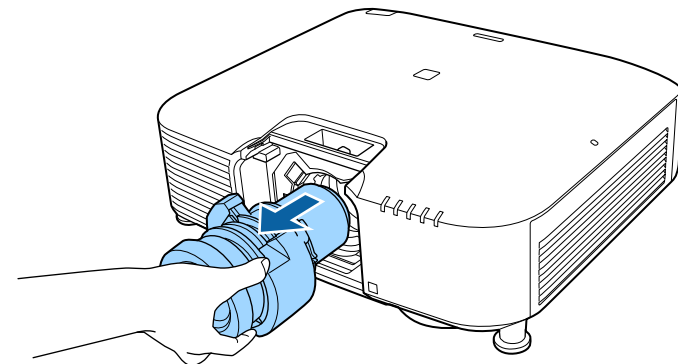

Follow the instructions in these sections to operate the projector power.

► Related Links

- "Turning On the Projector" p.35
- "Turning Off the Projector" p.36

Turning On the Projector

Turn on the computer or video equipment you want to use after you turn on the projector.

- 1** Connect the power cord to the projector's power inlet and plug it into an electrical outlet.

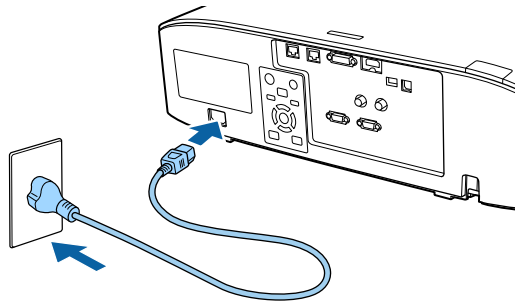

The projector's power indicator turns blue. This indicates that the projector is receiving power, but is not yet turned on (it is in standby mode).

- 2** Press the [On] button on the control panel or remote control to turn on the projector.

The projector beeps and the status indicator flashes blue as the projector warms up. Once the projector is warmed up, the status indicator stops flashing and turns blue.



- When **Quick Startup** is enabled in the projector's **Extended** menu, the projector becomes ready for use in several seconds the next time you press the power button.
☛ **Extended > Operation > Quick Startup**

Try the following if you do not see a projected image.

- Turn on the connected computer or video device.
- Change the screen output from the computer when using a laptop computer.
- Insert a DVD or other video media, and press play (if necessary).
- Press the [Search] button on the control panel or remote control to detect the source.
- Press the button for the desired video source on the remote control.
- If the Home screen is displayed, select the source you want to project.

⚠ Warning

- Never look into the projector lens when the light source is on. This can damage your eyes and is especially dangerous for children.
- When turning on the projector at a distance using the remote control, make sure there is no one looking into the lens.
- During projection, do not block the light from the projector with a book or other objects. If the light from the projector is blocked, the area on which the light shines becomes hot which could cause it to melt, burn, or start a fire. Also, the lens may get hot due to the reflected light which could cause the projector to malfunction. To stop projection, use the A/V Mute function, or turn off the projector.



- When the **Direct Power On** setting is set to **On** in the projector's **Extended** menu, the projector turns on as soon as you plug it in. Note that the projector also turns on automatically in cases such as recovery from a power outage.
 - ☛ **Extended > Operation > Direct Power On**
- If you select a specific port as the **Auto Power On** setting in the projector's **Extended** menu, the projector turns on as soon as it detects a signal or cable connection from that port.
 - ☛ **Extended > Operation > Auto Power On**

The projector beeps twice, the light source turns off, and the status indicator turns off.

- 3** To transport or store the projector, make sure the status indicator on the projector is off, and then unplug the power cord.

» Related Links

- "Home Screen" [p.49](#)

Turning Off the Projector

Turn off the projector after use.



- Turn off this product when it is not in use to prolong the life of the projector. Light source life varies depending on the mode selected, environmental conditions, and usage. Brightness decreases over time.
- Light source calibration starts automatically if you turn off the projector and the following conditions are present:
 - The **Light Source Calibration** setting is set to **Run Periodically** in the projector's **Reset** menu
 - 100 hours have passed since the last light source calibration
 - You have used the projector continuously for more than 20 minutes
- Since the projector supports the direct shutdown feature, it can be turned off directly using the breaker.

- 1** Press the [Standby] button on the control panel or remote control. The projector displays a shutdown confirmation screen.
- 2** Press the [Standby] button again. (To leave it on, press any other button.)

You can send images to your projector, as well as monitor and control your projector, over a network.

To perform these operations, connect the projector to your network, and then set up your projector and computer.

After connecting and setting up the projector as described here, download and install the following network software from the following Web site.

epson.sn

- Epson iProjection software sets up your computer for network projection. It also allows you to hold interactive meetings by projecting the user's computer screen over a network. See the *Epson iProjection Operation Guide (Windows/Mac)* for instructions.
- Epson Projector Management software (Windows only) sets up your computer for monitoring and controlling projectors. See the *Epson Projector Management Operation Guide* for instructions.

» Related Links

- "Connecting to a Wired Network" [p.37](#)
- "Selecting Wired Network Settings" [p.37](#)

Connecting to a Wired Network

To connect the projector to a wired local area network (LAN), use a 100Base-TX or 10Base-T network cable. To ensure proper data transmission, use a Category 5 shielded cable or better.

- 1** Connect one end of the network cable to your network hub, switch, or router.
- 2** Connect the other end of the cable to the projector's LAN port.

Selecting Wired Network Settings

Before you can project from computers on your network, you need to select network settings on the projector.



Make sure you already connected the projector to your wired network using the LAN port.

- 1** Press the [Menu] button, select the **Network** menu, and press [Enter].
- 2** Select **Network Configuration** and press [Enter].
- 3** Select the **Basic** menu and press [Enter].
- 4** Select the basic options as necessary.
 - **Projector Name** lets you enter a name up to 16 alphanumeric characters long to identify the projector over the network.
 - **PJLink Password** lets you enter a password up to 32 alphanumeric characters long for using the PJLink protocol for projector control.
 - **Remote Password** lets you enter a password up to 32 alphanumeric characters long to access the projector using the Basic Control. (User name is **EPSONREMOTE**; default password is the projector's serial number.)
 - **Web Control Password** lets you enter a password up to 32 alphanumeric characters long to access the projector over the Web. (User name is **EPSONWEB**; default password is the projector's serial number.)
 - **Moderator Password** lets you enter a four-digit number password for accessing the projector as a moderator using Epson iProjection. (No password is set by default.)
 - **Projector Keyword** lets you turn on a security password to prevent access to the projector by anyone not in the room with it. You must enter a displayed, randomized keyword from a computer using Epson iProjection to access the projector and share the current screen.

- **Display Keyword** lets you select whether to display a projector keyword on the projected image when accessing the projector using Epson iProjection.
- **Display LAN Info.** lets you set the display format for the projector's network information.



Use the displayed keyboard to enter numbers and characters. Press the arrow buttons on the remote control to highlight characters and press [Enter] to select them.

- 5** Select the **Wired LAN** menu and press [Enter].
- 6** Assign the IP settings for your network as necessary.
 - If your network assigns addresses automatically, select **IP Settings** to set the **DHCP** setting to **On**.
 - If you must set addresses manually, select **IP Settings** to set the **DHCP** setting to **Off**, and then enter the projector's **IP Address**, **Subnet Mask**, and **Gateway Address** as necessary.
 - If you want to connect the projector to the network using IPv6, select **IPv6 Settings** to set the **IPv6** setting to **On**, and then set the **Auto Configuration** and **Use Temporary Address** settings as necessary.



To highlight the numbers you want from the displayed keyboard, press the arrow buttons on the remote control. To select a highlighted number, press [Enter].

- 7** To prevent the IP address from being displayed on the LAN standby screen and Home screen, set the **IP Address Display** setting to **Off**.
- 8** When you finish selecting settings, select **Complete** and follow the on-screen instructions to save your settings and exit the menus.
- 9** Press the [LAN] button on the remote control.

The wired network settings complete when you see the correct IP address on the LAN standby screen.

» Related Links

- "Using the Displayed Keyboard" [p.51](#)

You can send images to your projector, as well as monitor and control your projector, over a network.

To perform these operations, you must install the Epson 802.11b/g/n wireless LAN module, and then set up your projector and computer using the projector's **Network** menu.

After setting up the projector, download and install the following network software from the following Web site.

epson.sn

- Epson iProjection (Windows/Mac) software allows you to hold interactive meetings by projecting the user's computer screen over a network. See the *Epson iProjection Operation Guide (Windows/Mac)* for instructions.
- Epson iProjection (iOS/Android) app allows you to project from iOS, Android, or Chromebook devices.
You can download Epson iProjection for free from the App Store or Google Play. Any fees incurred when communicating with the App Store or Google Play are the responsibility of the customer.
- Epson Projector Management software (Windows only) sets up your computer for monitoring and controlling projectors. See the *Epson Projector Management Operation Guide* for instructions.

» Related Links

- "Installing the Wireless LAN Module" [p.39](#)
- "Selecting Wireless Network Settings Manually" [p.40](#)
- "Selecting Wireless Network Settings in Windows" [p.41](#)
- "Selecting Wireless Network Settings in Mac" [p.41](#)
- "Setting Up Wireless Network Security" [p.42](#)
- "Using a QR Code to Connect a Mobile Device" [p.43](#)
- "Using a USB Key to Connect a Windows Computer" [p.44](#)

Installing the Wireless LAN Module

To use the projector over a wireless network, install the Epson 802.11b/g/n wireless LAN module. Do not install any other type of wireless LAN module.

Attention

Never remove the module while its indicator is blue or flashing, or while you are projecting wirelessly. This could damage the module or lose data.

- 1** Turn off the projector and unplug the power cord.
- 2** Loosen the screws and remove the air filter cover as shown (it is attached with a tether).

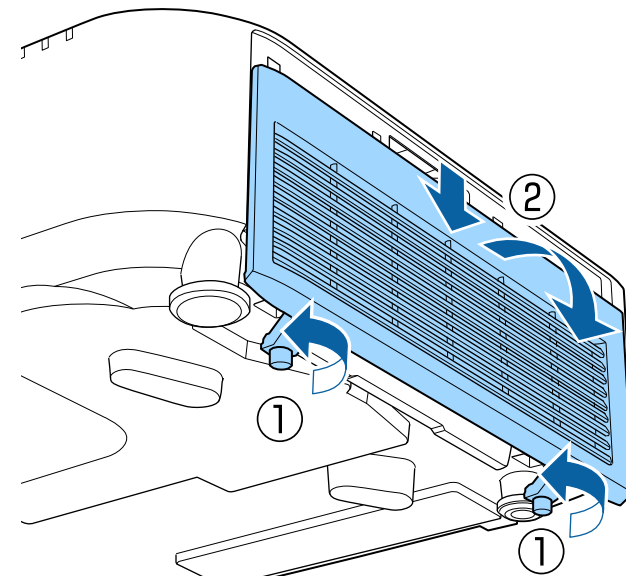

- 3** Connect the Wireless LAN module to the wireless LAN module slot.

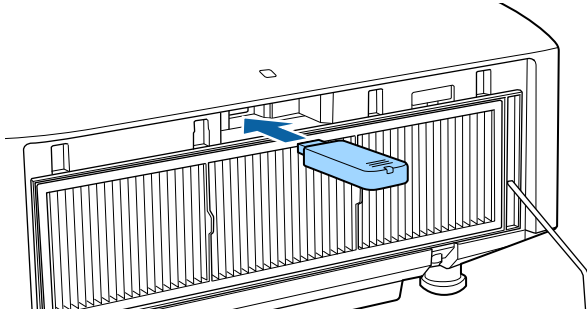

- 4** Replace the air filter cover as shown and tighten the screws.

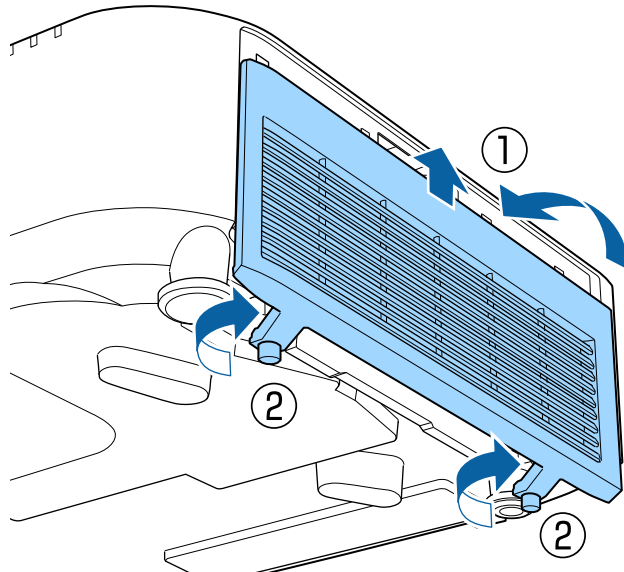

Selecting Wireless Network Settings Manually

Before you can project from your wireless network, you need to select network settings for the projector.

- 1** Press the [Menu] button, select the **Network** menu, and press [Enter].
- 2** Select **On** as the **Wireless LAN Power** setting.
- 3** Select **Network Configuration** and press [Enter].
- 4** Select the **Basic** menu and press [Enter].
- 5** Select the basic options as necessary.
 - **Projector Name** lets you enter a name up to 16 alphanumeric characters long to identify the projector over the network.
 - **PJLink Password** lets you enter a password up to 32 alphanumeric characters long for using the PJLink protocol for projector control.
 - **Remote Password** lets you enter a password up to 32 alphanumeric characters long to access the projector using the Basic Control. (User name is **EPSONREMOTE**; default password is the projector's serial number.)
 - **Web Control Password** lets you enter a password up to 32 alphanumeric characters long to access the projector over the Web. (User name is **EPSONWEB**; default password is the projector's serial number.)
 - **Moderator Password** lets you enter a four-digit number password for accessing the projector as a moderator using Epson iProjection. (No password is set by default.)
 - **Projector Keyword** lets you turn on a security password to prevent access to the projector by anyone not in the room with it. You must enter a displayed, randomized keyword from a computer using Epson iProjection to access the projector and share the current screen.

- **Display Keyword** lets you select whether to display a projector keyword on the projected image when accessing the projector using Epson iProjection.
- **Display LAN Info.** lets you set the display format for the projector's network information.



Use the displayed keyboard to enter numbers and characters. Press the arrow buttons on the remote control to highlight characters and press [Enter] to select them.

- 6** Select the **Wireless LAN** menu and press [Enter].
 - 7** Select the **Connection Mode** setting.
 - **Quick** lets you connect to multiple smartphones, tablets, or computers directly using wireless communication.
 - **Advanced** lets you connect to smartphones, tablets, or computers over a wireless network access point.
 - 8** If you selected the **Advanced** connection mode, select **Search Access Point** to select the access point you want to connect to.
-
- If you need to assign the SSID manually, select **SSID** to enter the SSID.
- 9** For the **Advanced** connection mode, assign the IP settings for your network as necessary.
 - If your network assigns addresses automatically, select **IP Settings** to set the **DHCP** setting to **On**.
 - If you must set addresses manually, select **IP Settings** to set the **DHCP** setting to **Off**, and then enter the projector's **IP Address**, **Subnet Mask**, and **Gateway Address** as necessary.
 - If you want to connect the projector to the network using IPv6, select **IPv6 Settings** to set the **IPv6** setting to **On**, and then set the **Auto Configuration** and **Use Temporary Address** settings as necessary.

- 10** To prevent the SSID or IP address from being displayed on the LAN standby screen and Home screen, set the **SSID Display** setting or the **IP Address Display** setting to **Off**.
- 11** When you finish selecting settings, select **Complete** and follow the on-screen instructions to save your settings and exit the menus.
- 12** Press the [LAN] button on the remote control.

The wireless network settings are complete when you see the correct IP address on the LAN standby screen.

When you have finished making wireless settings for your projector, you need to select the wireless network on your computer. Then start the network software to send images to your projector through a wireless network.

» Related Links

- "Using the Displayed Keyboard" [p.51](#)

Selecting Wireless Network Settings in Windows

Before connecting to the projector, select the correct wireless network on your computer.

- 1** To access your wireless utility software, click the network icon on the Windows taskbar.
- 2** When connecting in Advanced connection mode, select the network name (SSID) of the network the projector is connecting to.
- 3** Click **Connect**.

Selecting Wireless Network Settings in Mac

Before connecting to the projector, select the correct wireless network in Mac.

- 1 Click the Wi-Fi icon on the menu bar at the top of the screen.
- 2 When connecting in Advanced connection mode, make sure Wi-Fi is turned on and select the network name (SSID) of the network the projector is connecting to.

Setting Up Wireless Network Security

You can set up security for your projector to use on a wireless network. Set up one of the following security options to match the settings used on your network:

- WPA2-PSK security *
- WPA3-PSK security **
- WPA2/WPA3-PSK security **
- WPA3-EAP security **
- WPA2/WPA3-EAP security **

* Available only for the Quick connection mode.

** Available only for the Advanced connection mode.



Contact your network administrator for guidance on entering the correct information.

- 1 If you want to set up the WPA3-EAP or WPA2/WPA3-EAP security, make sure your digital certificate file is compatible with projector registration and placed directly on the USB storage device.
- 2 Press the [Menu] button, select the **Network** menu, and press [Enter].
- 3 Select **Network Configuration** and press [Enter].
- 4 Select the **Wireless LAN** menu and press [Enter].
- 5 Select the **Security** setting and press [Enter].

- 6 Select the security settings to match your network settings.
- 7 Do one of the following according to the security you selected.
 - **WPA2-PSK, WPA3-PSK, or WPA2/WPA3-PSK:** Select **Complete** and follow the on-screen instructions to save your settings and exit the menus.
 - **WPA3-EAP, WPA2/WPA3-EAP:** Select **EAP Method** and press [Enter].
- 8 Select the protocol for authentication as the **EAP Type** setting.
- 9 To import your certificate, select the certificate type and press [Enter].
 - **Client Certificate** for the **PEAP-TLS** or **EAP-TLS** type
 - **CA certificate** for all EAP types



You can also register the digital certificates from your Web browser. However, be sure to register just once or the certificate may not install correctly.

- 10 Select **Register** and press [Enter].
- 11 Follow the on-screen instructions to connect a USB storage device to the projector's USB-A port.
- 12 Press [Enter] to display the certificate list.
- 13 Select the certificate to import using the displayed list.

A message is displayed prompting you to enter the password for the certificate.
- 14 Enter a password and press [Enter].

The certificate is imported and a completion message appears.

15 Select your EAP settings as necessary.

- **User name** lets you enter a user name using up to 64 alphanumeric characters. To enter more than 32 characters, use your Web browser. When importing a client certificate, the name the certificate was issued to is automatically set.
- **Password** lets you enter a password using up to 64 alphanumeric characters for authentication when using the **PEAP**, **EAP-FAST**, or **LEAP** type. To enter more than 32 characters, use your Web browser.
- **Verify Server Cert.** lets you select whether or not to verify the server certificate when a CA certificate has been set.
- **RADIUS Serv.Name** lets you enter the server name to be verified.

16 When you have finished making settings, select **Complete** and follow the on-screen instructions to save your settings and exit the menus.

» **Related Links**

- "Supported Client and CA Certificates" p.43

Supported Client and CA Certificates

You can register these types of digital certificates.

Client Certificate (PEAP-TLS/EAP-TLS)

Specification	Description
Format	PKCS#12
Extension	PFX, P12
Encryption	RSA
Hashes	MD5/SHA-1/SHA-256/SHA-384/SHA-512
Key length	512/1024/2048/4096 bit
Password *	Up to 64 alphanumeric characters; required

CA Certificate (PEAP/PEAP-TLS/EAP-TLS/EAP-FAST)

Specification	Description
Format	X509v3
Extension	DER/CER/PEM
Encryption	RSA
Hashes	MD5/SHA-1/SHA-256/SHA-384/SHA-512
Key length	512/1024/2048/4096 bit
Encoding	BASE64/Binary

* You need to use your Web browser to enter more than 32 characters.

Using a QR Code to Connect a Mobile Device

After selecting the wireless network settings for your projector, you can display a QR code on the screen and use it to connect a mobile device using the Epson iProjection (iOS/Android) app.



- Make sure you have installed the latest version of Epson iProjection on your device.
- You can download Epson iProjection for free from the App Store or Google Play. Any fees incurred when communicating with the App Store or Google Play are the responsibility of the customer.
- When using Epson iProjection in Quick connection mode, we recommend making security settings.

- 1** Press the [LAN] button on the remote control.
The QR code is displayed on the projected surface.



- If you do not see the QR code, set the **Display LAN Info.** setting to **Text & QR Code** in the projector's **Network** menu.
☛ **Network > Network Configuration > Basic > Display LAN Info.**
- To hide the QR code, press [Esc].
- When the QR code is hidden, press [Enter] to display the code.

2 Start Epson iProjection on your mobile device.

3 Read the projected QR code using Epson iProjection to connect it to the projector.



To correctly read the QR code, make sure you face the screen squarely and closely enough so that the projected code fits into the guide of the mobile device's QR code reader. If you are too far from the screen, the code may not be read.

When a connection is established, select **Contents** menu from , and then select the file you want to project.

Using a USB Key to Connect a Windows Computer

You can set up your USB flash drive as a USB key to quickly connect the projector to a wireless LAN supported Windows computer. After creating the USB key, you can quickly project images from the network projector.

1 Set up the USB key using **USB Key Setup Tool** of the Epson iProjection (Windows) software.



See the *Epson iProjection Operation Guide (Windows/Mac)* for instructions.

2 Make sure the wireless LAN module is installed into your projector.

3 Turn on the projector.

4 Press the [LAN] button on the remote control.

The LAN standby screen is displayed. Verify that an SSID and IP address are displayed.

5 Remove the wireless LAN module from the projector's USB-A port (if installed) and insert the USB key into the same port.

You see a projected message that the network information update is complete.

6 Remove the USB key.

If your projector needs the wireless LAN module, reinsert the wireless LAN module into the projector.

7 Connect the USB key to a USB port on your computer.

8 Follow the on-screen instructions to install the necessary application.



- If the Windows Firewall message is displayed, click **Yes** to disable the firewall.
- You need administrator authority to install the software.
- If it is not installed automatically, double-click **MPPLaunch.exe** in the USB key.

After a few minutes, your computer image is displayed by the projector.

9 When you have finished projecting wirelessly, select the **Safely Remove Hardware** option in the Windows taskbar, and then remove the USB key from your computer.



You may need to restart your computer to reactivate your wireless LAN connection.

» Related Links

- "Getting the Latest Version of the Documents" [p.10](#)

You can use the HTTPS protocol to increase security between the projector and a Web browser communicating with it. To do this, you create a server certificate, install it on the projector, and turn on the **Secure HTTP** setting in the projector menus to verify the reliability of the Web browser.

☛ **Network > Network Configuration > Others > Secure HTTP**

Even if you do not install a server certificate, the projector automatically creates a self-signed certificate and allows communication. However, because the self-signed certificate cannot verify reliability from a Web browser, you see a warning about the server's reliability when you access the projector from a Web browser. This warning does not prevent communication.

▶ Related Links

- "Importing a Web Server Certificate Using the Menus" [p.46](#)

Importing a Web Server Certificate Using the Menus

You can create your Web server certificate and import it using the projector menus and an external storage device.



- You can use a USB flash drive as an external storage device for this model.
- You can also register the digital certificates from your Web browser. However, be sure to register just once or the certificate may not install correctly.

- 1** Make sure your digital certificate file is compatible with projector registration and directly placed on the USB storage device.
- 2** Press the [Menu] button, select the **Network** menu, and press [Enter].
- 3** Select **Network Configuration** and press [Enter].
- 4** Select the **Others** menu and press [Enter].
- 5** Set the **Secure HTTP** setting to **On**.

- 6** Select **Web Server Cert.** and press [Enter].
- 7** Select **Register** and press [Enter].
- 8** Follow the on-screen instructions to connect a USB storage device to the projector's USB-A port.
- 9** Press [Enter] to display the certificate list.
- 10** Select the certificate to import using the displayed list.
A message is displayed prompting you to enter the password for the certificate.
- 11** Enter a password and press [Enter].
The certificate is imported and a completion message appears.

▶ Related Links

- "Supported Web Server Certificates" [p.46](#)

Supported Web Server Certificates

You can register these types of digital certificates.

Web Server Certificate (Secure HTTP)

Specification	Description
Format	PKCS#12
Extension	PFX, P12
Encryption	RSA
Hashes	MD5/SHA-1/SHA-256/SHA-384/SHA-512
Key length	512/1024/2048/4096 bit
Common name	Network host name
Organization	Optional
Password *	Up to 64 alphanumeric characters; required

* You need to use your Web browser to enter more than 32 characters.

Adjusting the Menu Settings

Follow the instructions in these sections to access the projector menu system and change projector settings.

► Related Links

- "Home Screen" [p.49](#)
- "Using the Projector's Menus" [p.50](#)
- "Using the Displayed Keyboard" [p.51](#)
- "Using Basic Projector Features" [p.52](#)
- "Copying Menu Settings Between Projectors (Batch Setup)" [p.65](#)

The Home screen feature allows you to easily select an image source and access useful functions. You can display the Home screen by pressing the [Home] button on the remote control. The Home screen is also displayed when you turn on the projector and no signal is being input.

Press the arrow buttons on the remote control to select a menu item, and then press [Enter].

 The Home screen disappears after 10 minutes of inactivity.

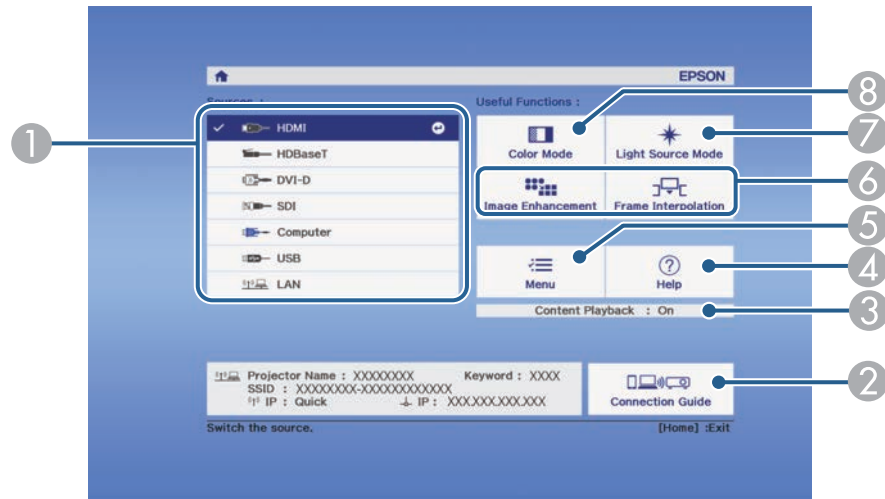

- ① Selects the source you want to project.
- ② Displays the Connection Guide. You can select the wireless connection methods according to the devices you are using, such as smartphones or computers.
- ③ Indicates the projector is in Content Playback mode.
- ④ Displays the Help screen.
- ⑤ Displays the projector's menu.
- ⑥ Performs menu options assigned to **Home Screen** in the projector's **Extended** menu.
- ⑦ Selects the brightness for the light source.
- ⑧ Changes the projector's color mode.

You can use the projector's menus to adjust the settings that control how your projector works. The projector displays the menus on the screen.

- 1 Press the [Menu] button on the control panel or remote control.
You see the menu screen displaying the **Image** menu settings.

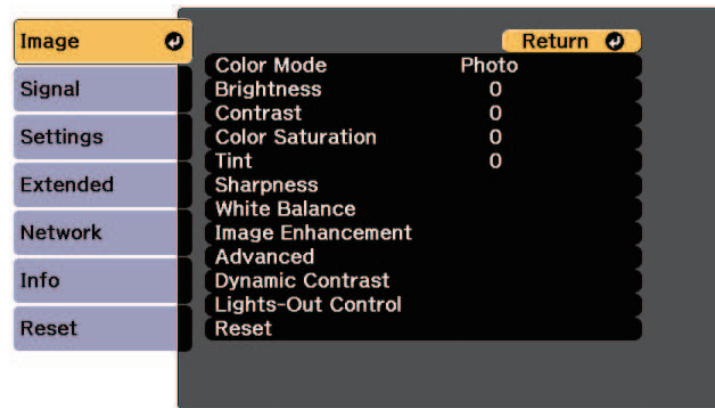

- 2 Press the up or down arrow buttons to move through the menus listed on the left. The settings for each menu are displayed on the right.



The available settings depend on the current input source.

- 3 To change settings in the displayed menu, press [Enter].
- 4 Press the up or down arrow button to move through the settings.
- 5 Change the settings using the buttons listed on the bottom of the menu screens.
- 6 To return all the menu settings to their default values, select **Reset**.
- 7 When you finish changing settings on a menu, press [Esc].

- 8 Press [Menu] or [Esc] to exit the menus.

You can use the displayed keyboard to enter numbers and characters.

- 1 Use the arrow buttons on the control panel or remote control to highlight the number or character you want to enter and press the [Enter] button.

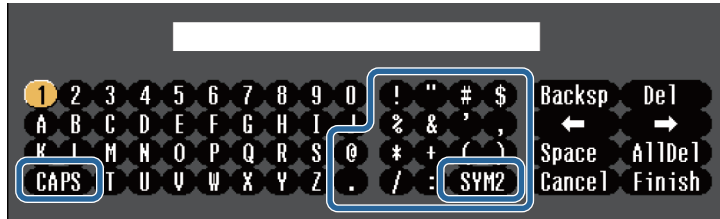

 Each time you select the **CAPS** key, the characters change between upper case and lower case. Each time you select the **SYM1/2** key, the symbols enclosed by the frame change.

- 2 After entering the text, select **Finish** on the keyboard to confirm your entries. Select **Cancel** to cancel entering text.

 You can select projector settings and control projection over a network using a Web browser from your computer.
Some symbols cannot be entered using the displayed keyboard. Use your Web browser to enter the text.

Text type	Details
Numbers	0123456789
Alphabet	ABCDEFGHIJKLMNOPQRSTUVWXYZ abcdefghijklmnopqrstuvwxyz
Symbols	!"#\$%&'()*+,-./:;<=>?@[\] ^_`{ }~

» **Related Links**

- "Available Text Using the Displayed Keyboard" [p.51](#)

Available Text Using the Displayed Keyboard

You can enter the following text when using the displayed keyboard.

Follow the instructions in these sections to use your projector's basic features.

» Related Links

- "Setting Up the Projector" [p.52](#)
- "Projecting Images" [p.53](#)
- "Adjusting the Image Position and Shape" [p.55](#)
- "Adjusting the Image Quality" [p.58](#)
- "Using Multiple Projectors" [p.60](#)
- "Maintaining the Projector Quality" [p.61](#)
- "Managing the Projector's Settings" [p.62](#)

Setting Up the Projector

This section provides instructions on setting up your projector.

» Related Links

- "Messages" [p.52](#)
- "Standby Confirmation" [p.52](#)
- "Sleep Mode" [p.52](#)
- "Beep" [p.52](#)
- "Indicators" [p.53](#)
- "Date & Time" [p.53](#)
- "Language" [p.53](#)
- "On-Screen Display" [p.53](#)

Messages

You can display or hide messages such as the input source name, color mode name, aspect ratio, no signal message, or high temperature warning on the projected image.

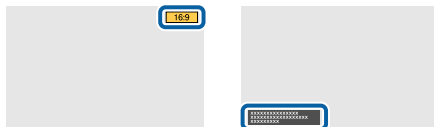

Execution Method

☛ Extended > Display > Messages

Standby Confirmation

When set to **Off**, you can turn off the projector simply by pressing the power button once.

Execution Method

☛ Extended > Display > Standby Confirmation

Sleep Mode

When set to **On**, the projector automatically turns off after an interval of inactivity.

You can also set the interval in the **Sleep Mode Timer** setting.

Execution Method

☛ Extended > Operation > Sleep Mode

☛ Extended > Operation > Sleep Mode Timer

Beep

When set to **Off**, you can turn off the confirmation buzzer beeps to notify you that the power turns on or off, or cooling down is finished.

Execution Method

☛ Extended > Operation > Advanced > Beep

Indicators

When set to **Off**, you can turn off the indicator lights on the projector.

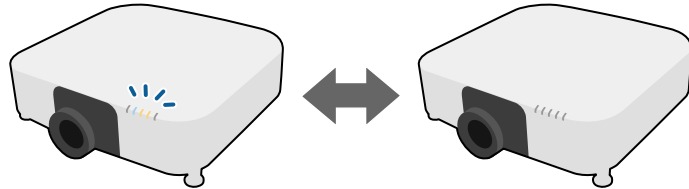

Execution Method

☛ **Extended > Operation > Advanced > Indicators**

Date & Time

You can adjust the projector's system time and date settings.

Execution Method

☛ **Extended > Operation > Date & Time**

Language

You can select the language for projector menu and message displays.

Execution Method

☛ **Extended > Language**

On-Screen Display

You can display or hide the menus or messages on the projected image. Make sure you assign **On-Screen Display** to any [User] button on the remote control in the **Settings** menu.

☛ **Settings > User Button**

Execution Method

Press the [User] button on the remote control to which **On-Screen Display** is assigned.



- Menus and messages are displayed or hidden each time you press the button.
- If **On-Screen Display** is enabled, you cannot operate the projector's menu (except to switch the color mode and input source).

Projecting Images

This section provides instructions to project images.

» Related Links

- "Source Search" [p.53](#)
- "A/V Mute" [p.54](#)
- "Freeze" [p.54](#)
- "Split Screen" [p.54](#)
- "Volume" [p.54](#)
- "Test Pattern" [p.55](#)
- "Content Playback" [p.55](#)
- "Display Background" [p.55](#)
- "Startup Screen" [p.55](#)

Source Search

When multiple image sources are connected to the projector, such as a computer and DVD player, you can switch from one image source to the other.

Execution Method

- Press the [Search] (remote control) or [Source Search] (control panel) button on the control panel or remote control until you see the image from the source you want.
- Press the button for the source you want on the remote control. If there is more than one port for that source, press the button again to cycle through the sources.
- Press the [Home] button on the remote control. Then select the source you want to use from the screen displayed.

A/V Mute

You can temporarily turn off the projected image and sound. Any sound or video action continues to run, however, so you cannot resume projection at the point that you stopped it.

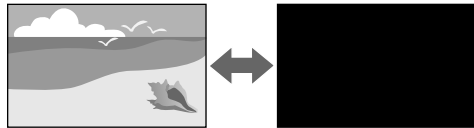

Execution Method

Press the [A/V Mute] button on the control panel or remote control. To turn the image and sound back on, press [A/V Mute] again.



- You can add a fade out or fade in effect when turning the video on or off.
- You can limit the way the A/V Mute function is released.
 - ☛ **Extended > Operation > A/V Mute Settings**

Freeze

You can temporarily stop the action in a video or computer presentation and keep the current image on the screen. Any sound or video action continues to run, however, so you cannot resume projection at the point that you stopped it.

Execution Method

Press the [Freeze] button on the remote control. To restart the video action in progress, press [Freeze] again.

Split Screen

You can use the **Split Screen** feature to simultaneously project two images from different image sources.

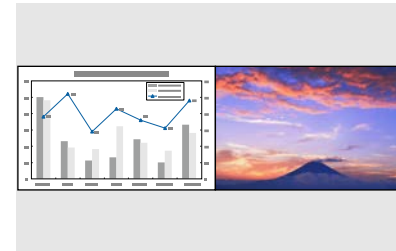

Execution Method

- Press the [Split] buttons on the remote control
- Change the projector's menu:
 - ☛ **Settings > Split Screen**

Volume

You can adjust the volume of the audio from the Audio Out port.

Execution Method

- Press the [Volume] buttons on the remote control.
- Change the projector's menu:
 - ☛ **Settings > Volume**

Test Pattern

You can display a test pattern to adjust the projected image without connecting a computer or video device.

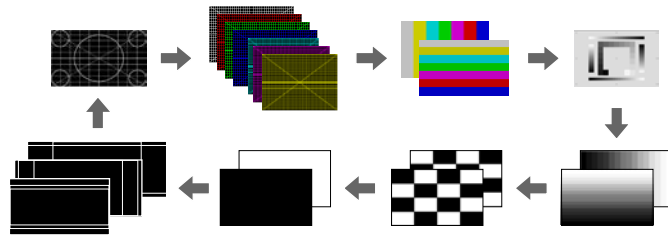

Execution Method

- Press the [Test Pattern] button on the control panel or remote control.
- Change the projector's menu:
 - ☛ Settings > Test Pattern

Content Playback

Your projector's Content Playback feature allows you to project your digital signage content. You can also add color and shape effects to your projected image.



You can use the following tool to create content that can be played in Content Playback mode.

- Epson Projector Content Manager
- Epson Web Control
- Epson Creative Projection

Execution Method

- ☛ Settings > Content Playback

Display Background

You can select the screen background when no image signal is available.

Execution Method

- ☛ Extended > Display > Display Background

Startup Screen

When set to **On**, a logo is displayed when the projector starts up.

Execution Method

- ☛ Extended > Display > Startup Screen

Adjusting the Image Position and Shape

This section provides instructions to adjust the image position and shape without moving the projector.

► Related Links

- "Lens Shift" [p.56](#)
- "Zoom" [p.56](#)
- "Aspect" [p.56](#)
- "H/V-Keystone" [p.57](#)
- "Quick Corner" [p.57](#)
- "Curved Surface" [p.57](#)
- "Corner Wall" [p.57](#)

- "Point Correction" p.58
- "Screen Type" p.58
- "Projection" p.58

Lens Shift

If you cannot install the projector directly in front of the screen, you can adjust the position of the projected image using the lens shift feature.

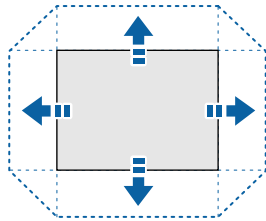

You can check the available lens shift range in the projector's *Specifications*.

Execution Method

- Press the [Lens Shift] button on the remote control.
- Press the [Lens] button on the control panel until the lens shift adjustment screen is displayed.

Caution

When shifting the lens, do not put your hands near the lens unit. Your fingers may get caught between the lens unit and the projector, and cause an injury.



- Wait 20 minutes after turning on the projector before setting the lens shift for maximum accuracy.
- When adjusting the image height, position the image lower than where you want it to be and then move it up. This will help prevent the image from moving down after adjustment.
- The image is clearest when the lens is at the home position. To move the lens to the home position, hold the [Lens Shift] button on the remote control or the [Lens] button on the control panel for more than 3 seconds.

Zoom

You can resize the image.

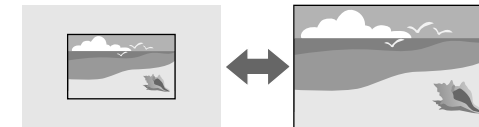

Execution Method

- Press the [Zoom] button on the remote control.
- Press the [Lens] button on the control panel until the zoom adjustment screen is displayed.

Aspect

The projector can display images in different width-to-height ratios called aspect ratios. Normally, the input signal from your video source determines the image's aspect ratio. However, you can change the aspect ratio for certain images to fit your screen.



Execution Method

- Press the [Aspect] button on the remote control.
- Change the projector's menu:
 - ☛ **Signal > Aspect**



If you always want to use a particular aspect ratio for a certain video input source, you can select it using the projector's **Signal** menu.

H/V-Keystone

You can correct distortion in the horizontal and vertical directions independently.

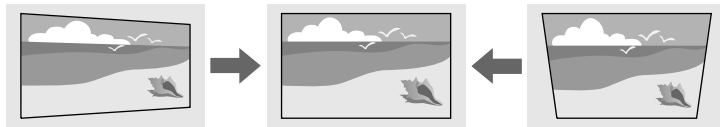

Execution Method

- ☛ **Settings > Geometry Correction > H/V-Keystone**

Quick Corner

You can correct each of the four corners of the projected image independently.

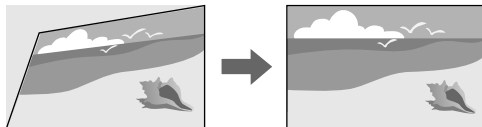

Execution Method

- ☛ **Settings > Geometry Correction > Quick Corner**

Curved Surface

You can correct the corners and sides of an image projected on a curved surface with the same radius.

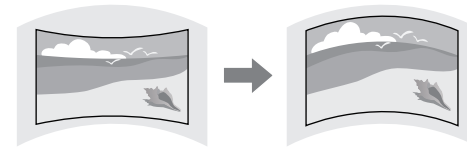

Execution Method

- ☛ **Settings > Geometry Correction > Curved Surface**

Corner Wall

You can correct the corners and sides of an image projected on a curved surface with right angles.

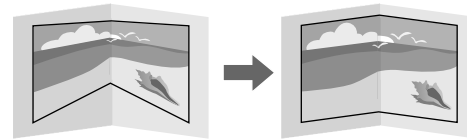

Execution Method

- ☛ **Settings > Geometry Correction > Corner Wall**

Point Correction

This feature divides the projected image into a grid and corrects the distortion in 0.5 pixel increments by moving the selected point of intersection from side to side and up and down.

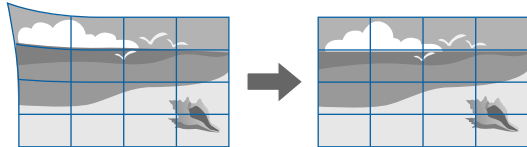

Execution Method

☛ Settings > Geometry Correction > Point Correction

Screen Type

You can use the **Screen Type** setting to match the aspect ratio of the displayed image to the screen you are using.

Execution Method

☛ Extended > Display > Screen > Screen Type



- Adjust the aspect ratio for the projected image, if necessary.
- When the **Screen Type** setting changes, the **EDID** settings are automatically adjusted.

Projection

You can change the projection mode to flip the image over top-to-bottom and/or left-to-right using the projector menus.

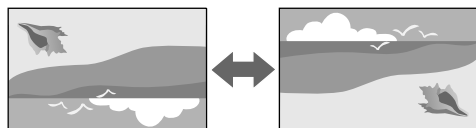

Execution Method

☛ Extended > Projection



You can change the projection mode to flip the image over top-to-bottom by holding down the [A/V Mute] button on the remote control for approximately 5 seconds.

Adjusting the Image Quality

This section provides instructions to adjust the quality of your image.

▶ Related Links

- "Focus" [p.58](#)
- "Color Mode" [p.59](#)
- "Image Enhancement" [p.59](#)
- "Gamma" [p.59](#)
- "RGBCMY" [p.60](#)
- "Brightness Settings" [p.60](#)

Focus

You can correct the focus.

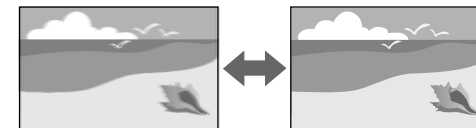

Execution Method

- Press the [Focus] button on the remote control.
- Press the [Lens] button on the control panel until the focus adjustment screen is displayed.



- If you installed an optional short throw lens, you may need to first focus on the center of your screen and then correct any distortion in the surrounding area.
- If you installed the optional ELPLU02 short throw lens, manually rotate the distortion ring counterclockwise to manually adjust the image distortion. Adjust the focus and then rotate the distortion ring again to correct image distortion.

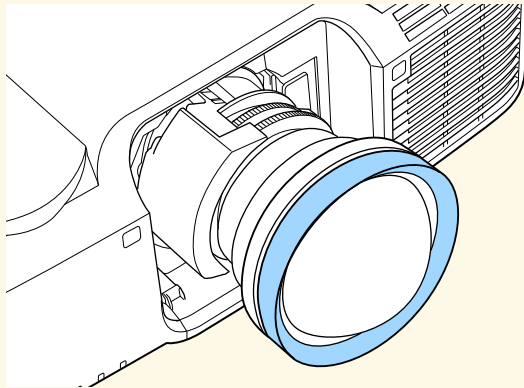

Color Mode

The projector offers different color modes to provide optimum brightness, contrast, and color for a variety of viewing environments and image types. You can select the mode designed to match your image and environment, or experiment with the available modes.

Execution Method

- Press the [Color Mode] button on the remote control.
- Change the projector's menu:
 - ☛ **Image > Color Mode**

Image Enhancement

You can adjust the resolution of the image to reproduce a clear image with an emphatic texture and material feel.

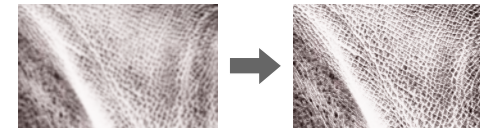

Execution Method

- ☛ **Image > Image Enhancement**

Gamma

You can adjust the halftone brightness by selecting one of the gamma correction values, or referring to a gamma graph.

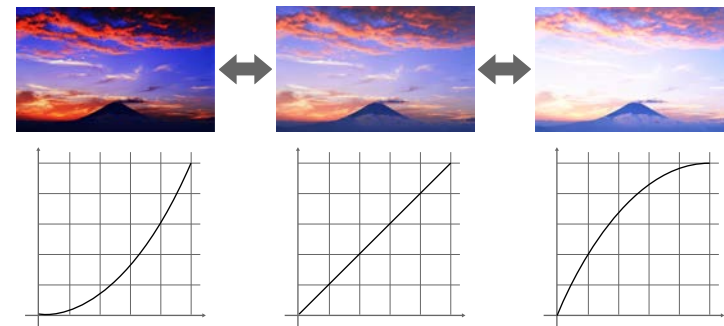

Execution Method

- ☛ **Image > Advanced > Gamma**

RGBCMY

You can adjust the Hue, Saturation, and Brightness of each color R (red), G (green), B (blue), C (cyan), M (magenta), Y (yellow) individually.



Execution Method

☛ Image > Advanced > RGBCMY

Brightness Settings

You can select the brightness for the light source.



Execution Method

☛ Settings > Brightness Settings

Using Multiple Projectors

You can combine the projected images from two or more projectors to create one unified image area.

▶ Related Links

- "Tiling" [p.60](#)

- "Edge Blending" [p.60](#)
- "Black Level" [p.61](#)
- "Scale" [p.61](#)
- "Color Matching" [p.61](#)

Tiling

You can assign a projection position to each projector.

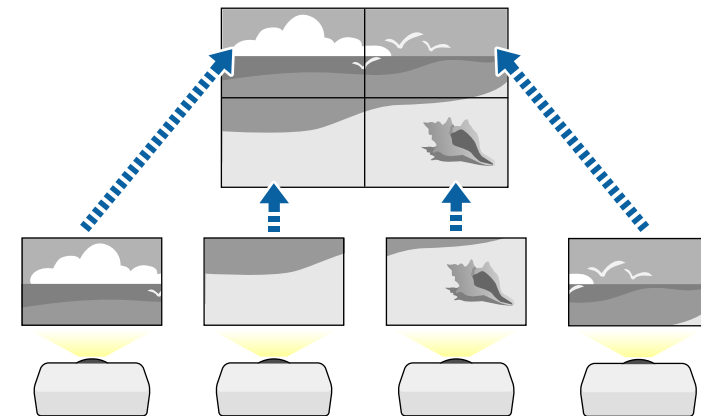

Execution Method

☛ Extended > Multi-Projection > Tiling

Edge Blending

You can use the **Edge Blending** feature to create a seamless image from multiple projectors.

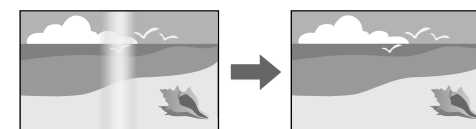

Execution Method

Extended > Multi-Projection > Edge Blending

Black Level

You can adjust the brightness and color tone of the areas where the images do not overlap to create a seamless image.

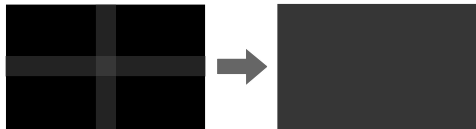

Execution Method

Extended > Multi-Projection > Black Level

Scale

You can use the **Scale** feature to crop and combine them into one unified image area.

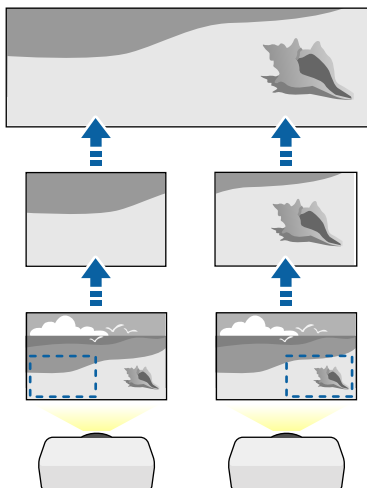

Execution Method

Extended > Multi-Projection > Scale

Color Matching

You can match the display quality of multiple projectors that will project next to each other.

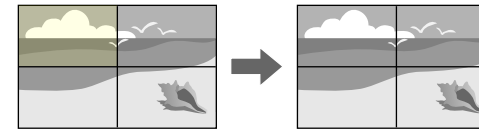

Execution Method

Extended > Multi-Projection > Screen Matching > Color Matching

Maintaining the Projector Quality

This section provides information about maintaining the quality of projected images.

► Related Links

- "Panel Alignment" [p.61](#)
- "Color Uniformity" [p.62](#)
- "Refresh Mode" [p.62](#)
- "Light Source Calibration" [p.62](#)

Panel Alignment

You can adjust the pixel color shift for the LCD panel. You can adjust the pixels horizontally and vertically in 0.125 pixels increments within a range of ± 3 pixels.

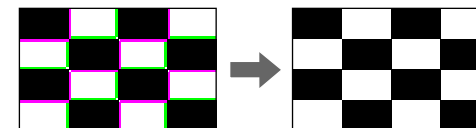

Execution Method

☛ Extended > Display > Panel Alignment

Color Uniformity

If the color tone of the image is uneven, you can adjust the color tone balance.

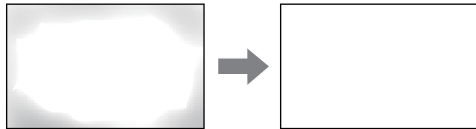

Execution Method

☛ Extended > Display > Color Uniformity

Refresh Mode

The refresh mode process clears any projected afterimage and turns off the projector after a specified period of time.

Execution Method

☛ Reset > Refresh Mode

Light Source Calibration

The light source calibration process optimizes the color balance of the currently projected image.

Execution Method

☛ Reset > Light Source Calibration

» Related Links

- "Memory" [p.62](#)
- "Schedule Settings" [p.62](#)
- "Button Lock" [p.63](#)
- "Password Protection" [p.64](#)

Memory

You can save customized settings and then select the saved settings whenever you want to use them.

Execution Method

- Press the [Memory] button on the remote control.
- Change the projector's menu:
 - ☛ Settings > Memory

Schedule Settings

You can schedule up to 30 events to occur automatically on your projector, such as turning the projector on or off or switching the input source. The projector performs the selected events on the specified date and time in the schedule you set up.

Execution Method

☛ Extended > Schedule Settings

Managing the Projector's Settings

This section provides information about managing the projector's settings.

Button Lock

Button lock security to block operation of the projector using the buttons on the control panel or remote control.

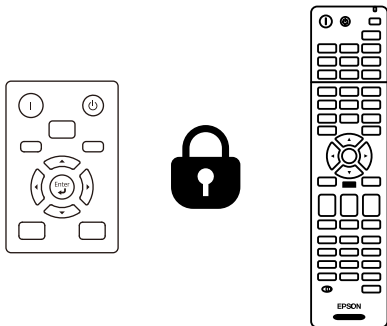

Even if you can lock the buttons on the control panel, you can still use the remote control as usual.

The remote control buttons lock feature locks the following buttons.

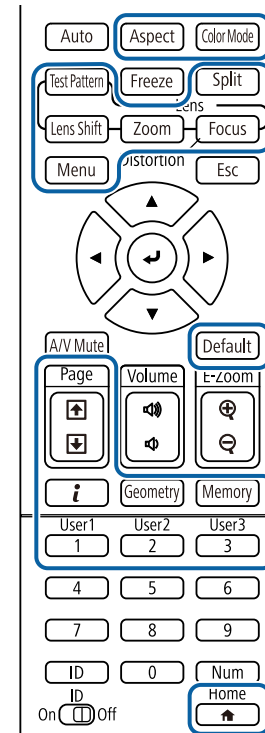

Execution Method

- To lock the control panel buttons, hold down the control panel lock button on the control panel.
To unlock the control panel buttons, hold down the [Enter] button on the control panel for approximately 7 seconds.
- To lock the remote control buttons, hold down the [Home] button on the remote control for approximately 5 seconds.
To unlock the remote control buttons, hold down the [Home] button again for approximately 5 seconds.

Password Protection

Password security to prevent people who do not know the password from using the projector, and prevent changes to the startup screen and other settings.

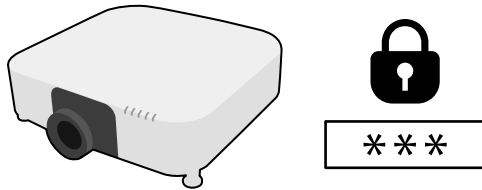

You can set up the following types of password security using one shared password:

- **Power On Protection** prevents anyone from using the projector without first entering a password. When plugging the power cord and turning on the projector at first time, you must enter the correct password. This also applies to **Direct Power On** and **Auto Power On**.
- **User's Logo Protection** prevents anyone from changing the custom screen displayed when the projector turns on, when no signal is being input, or when you use the A/V Mute feature. The custom screen discourages theft by identifying the projector's owner.
- **Network Protection** prevents anyone from changing the projector's **Network** settings.
- **Schedule Protection** prevents anyone from changing the projector's schedule settings.
- **Remote Camera Access** prevents anyone from using the Remote Camera Access function.

Execution Method

Hold the [Freeze] button on the remote control for approximately 5 seconds.



You can set a four-digit password. Hold down the [Num] button on the remote control and use the numeric buttons to set a password. The default password is set to "0000".

Attention

- If an incorrect password is entered three times in succession, the message "The projector's operation will be locked." is displayed for approximately 5 minutes, and the projector switches to standby mode. If this happens, disconnect the power plug from the electrical outlet, reinsert it, and turn the projector back on. The projector displays the password entry screen again so that you can enter the correct password.
- If you have forgotten the password, make a note of the "**Request Code: xxxxx**" number that appears on the screen and contact Epson for help.
- If you continue to repeat the above operation and input the wrong password 30 times in succession, the message "The projector's operation will be locked. Contact Epson as described in your documentation." is displayed and the projector does not accept any more password entries. Contact Epson for help.

After selecting the projector's menu settings for one projector, you can use the following methods to copy the settings to other projectors, as long as they are the same model.

- by using a USB flash drive
- by connecting a computer and projector using a USB cable
- by using Epson Projector Management
- by using Projector Config Tool

You cannot copy any information unique to an individual projector, such as **Light Source Hours** or **Status**.



- Perform batch setup before adjusting the image settings such as keystone distortion correction. Since image adjustment values are also copied to another projector, the adjustments you made before performing the batch setup are overwritten and the projected screen you adjusted may change.
- When copying the menu settings from one projector to another, user's logo is also copied. Do not register the information that you do not want to share between multiple projectors as a user's logo.
- Make sure **Batch Setup Range** is set to **Limited** if you do not want to copy the following settings:
 - **Password Protection** settings
 - **EDID** in the **Signal** menu
 - **Network** menu settings (except for the **Notifications** menu and the **Others** menu)
- You can only copy the following settings using the Projector Config Tool:
 - Projector Name
 - Asset information
 - IP Address for a wired network
 - Subnet Mask for a wired network
 - NFC Write Password



Caution

Epson takes no responsibility for batch setup failures and associated repair costs due to power outages, communication errors, or other problems that may cause such failures.

► Related Links

- "Transferring Settings From a USB Flash Drive" [p.65](#)
- "Transferring Settings From a Computer" [p.66](#)
- "Batch Setup Error Notification" [p.67](#)

Transferring Settings From a USB Flash Drive

You can copy menu settings from one projector to another of the same model using a USB flash drive.



The USB flash drive must use a FAT format and not incorporate any security function. Delete any files on the drive before using it for batch setup or the settings may not be saved correctly.

- 1** Disconnect the power cord from the projector, and check that all of the projector's indicators have turned off.
- 2** Connect an empty USB flash drive directly to the projector's USB-A port.
- 3** Hold down the [Esc] button on the remote control or the control panel and connect the power cord to the projector.
- 4** When all of the projector's indicators other than the filter indicator turn on, release the [Esc] button.

The indicators start flashing and the batch setup file is written to the USB flash drive. When writing is finished, the projector turns off.

Caution

Do not disconnect the power cord or the USB flash drive from the projector while the file is being written. If the power cord or USB flash drive is disconnected, the projector may not start correctly.

- 5** Remove the USB flash drive.



The file name for the batch setup file is PJCONFDATA.bin. If you need to change the file name, add text after PJCONFDATA using only alphanumeric characters. If you change the PJCONFDATA section of the file name, the projector may not be able to recognize the file correctly.

- 6** Disconnect the power cord from the projector to which you want to copy settings, and check that all of the projector's indicators have turned off.
- 7** Connect the USB flash drive containing the saved batch setup file to the projector's USB-A port.
- 8** Hold down the [Menu] button on the remote control or the control panel and connect the power cord to the projector.
- 9** When all of the projector's indicators other than the filter indicator turn on, release the [Menu] button. (The indicators remain on for approximately 75 seconds.)

When all of the indicators start flashing, the settings are being written. When writing is finished, the projector turns off.

Caution

Do not disconnect the power cord or the USB flash drive from the projector while the file is being written. If the power cord or USB flash drive is disconnected, the projector may not start correctly.

- 10** Remove the USB flash drive.

Transferring Settings From a Computer

You can copy menu settings from one projector to another of the same model by connecting the computer and projector with a USB cable.



You can use this batch setup method with the following operating system versions:

- Windows 7 and later
- OS X 10.11.x and later

- 1** Disconnect the power cord from the projector, and check that all of the projector's indicators have turned off.
- 2** Connect a USB cable to the computer's USB port and to the projector's Service port.
- 3** Hold down the [Esc] button on the remote control or the control panel and connect the power cord to the projector.
- 4** When all of the projector's indicators other than the filter indicator turn on, release the [Esc] button.
The computer recognizes the projector as a removable disk.
- 5** Open the removable disk icon or folder, and save the batch setup file to the computer.



The file name for the batch setup file is PJCONFDATA.bin. If you need to change the file name, add text after PJCONFDATA using only alphanumeric characters. If you change the PJCONFDATA section of the file name, the projector may not be able to recognize the file correctly.

- 6** Eject the USB device (Windows) or drag the removable disk icon to the Trash (Mac).
- 7** Disconnect the USB cable.

The projector turns off.

8 Disconnect the power cord from the projector to which you want to copy settings, and check that all of the projector's indicators have turned off.

9 Connect the USB cable to the computer's USB port and to the projector's Service port.

10 Hold down the [Menu] button on the remote control or the control panel and connect the power cord to the projector.

11 When all of the projector's indicators other than the filter indicator turn on, release the [Menu] button.

The computer recognizes the projector as a removable disk.

12 Copy the batch setup file (PJCONFDATA.bin) that you saved to your computer to the top level folder of the removable disk.



Do not copy any files or folders other than the batch setup file to the removable disk.

13 Eject the USB device (Windows) or drag the removable disk icon to the Trash (Mac).

14 Disconnect the USB cable.

When all of the indicators start flashing, the settings are being written. When writing is finished, the projector turns off.

⚠ Caution

Do not disconnect the power cord from the projector while the file is being written. If the power cord is disconnected, the projector may not start correctly.

Batch Setup Error Notification

The projector's indicators notify you if an error occurs during a batch setup operation. Check the status of the projector's indicators and follow the instructions described in the table here.

Indicator status	Problem and solutions
<ul style="list-style-type: none"> • Laser: Orange - flashing fast • Temp: Orange - flashing fast 	<p>The batch setup file may be corrupt, or the USB flash drive may not be connected correctly.</p> <p>Disconnect the USB flash drive, unplug and then plug in the projector's power cord, and then try again.</p>
<ul style="list-style-type: none"> • Power: Blue - flashing fast • Status: Blue - flashing fast • Laser: Orange - flashing fast • Temp: Orange - flashing fast 	<p>Writing the settings may have failed and an error may have occurred in the projector's firmware.</p> <p>Stop using the projector, remove the power plug from the electrical outlet. Contact Epson for help.</p>

Menu Settings

Refer to these sections to learn more about your projector's settings.

► Related Links

- "Image Menu" [p.69](#)
- "Signal Menu" [p.75](#)
- "Settings Menu" [p.79](#)
- "Extended Menu" [p.88](#)
- "Network Menu" [p.101](#)
- "Info Menu" [p.110](#)
- "Reset Menu" [p.113](#)

Settings on the **Image** menu let you adjust the quality of your image. The available settings depend on the currently selected color mode and input source. The settings are saved separately for each selected color mode.

► Related Links

- "Color Mode" [p.69](#)
- "Brightness" [p.69](#)
- "Contrast" [p.69](#)
- "Color Saturation" [p.70](#)
- "Tint" [p.70](#)
- "Sharpness" [p.70](#)
- "White Balance" [p.70](#)
- "4K Enhancement" [p.70](#)
- "Image Preset Mode" [p.71](#)
- "Frame Interpolation" [p.71](#)
- "Deinterlacing" [p.71](#)
- "Noise Reduction" [p.72](#)
- "MPEG Noise Reduction" [p.72](#)
- "Super-resolution" [p.72](#)
- "Detail Enhancement" [p.72](#)
- "Reset (Image Enhancement)" [p.72](#)
- "Scene Adaptive Gamma" [p.73](#)
- "Gamma" [p.73](#)
- "RGBCMY" [p.73](#)
- "Dynamic Contrast" [p.73](#)
- "Lights-Out Control" [p.74](#)
- "Reset (Image menu)" [p.74](#)

Color Mode

☛ Image > Color Mode

☛ Extended > Multi-Projection > Screen Matching > Color Mode

You can adjust the vividness of image colors for various image types and environments. The brightness of the image varies depending on the mode selected.

Dynamic

This is the brightest mode. Ideal for use in a bright room.

Presentation

The images are vivid and brought to life. Ideal for making presentations or watching a TV program in a bright room.

Natural

Reproduces colors faithfully. Ideal for projecting still pictures such as photos.

Cinema

Gives images a natural tone. Ideal for watching films in a dark room.

BT.709

Produces images that conform to the ITU-R BT.709.

DICOM SIM

This produces images with clear shadows. Ideal for projecting X-ray photographs and other medical images. The projector is not a medical device and cannot be used for medical diagnosis.

Multi-Projection

Minimize the color tone difference between each projected image. Ideal for projecting from multiple projectors.



You can also change the projector's Color Mode using the [Color Mode] button on the remote control.

Brightness

☛ Image > Brightness

You can lighten or darken the overall image.

Contrast

☛ Image > Contrast

You can adjust the difference between light and dark areas of the image.

Color Saturation

☛ Image > Color Saturation

You can adjust the intensity of the image colors.

Tint

☛ Image > Tint

You can adjust the balance of green to magenta tones in the image.

Sharpness

☛ Image > Sharpness

You can adjust the sharpness or softness of image details.

Standard

You can adjust the image sharpness so that it is sufficiently balanced.

Thin Line Enhancement

Higher values enhance the details such as hair or fabric patterns.

Thick Line Enhancement

Higher values enhance the outline, background, and the other main parts of the objects in the image to show them clearly.

White Balance

☛ Image > White Balance

You can adjust the overall tint of the image.

Color Temp.

You can adjust the overall tint of the image within a range from 3200K to 10000K. Higher values tint the image blue and lower values tint the image red.

When **Color Mode** is set to **Dynamic**, the set Color Temp. may differ from the actual Color Temp. of the light from the projector. Use this menu as a guide.

G-M Correction

Higher values tint the image green and lower values tint the image red.

Offset R/Offset G/Offset B/Gain R/Gain G/Gain B

You can adjust the individual R (red), G (green), and B (blue) components of the offset and gain.

4K Enhancement

☛ Image > Image Enhancement > 4K Enhancement

You can project an image at a doubled resolution by diagonally shifting 1 pixel in increments of 0.5 pixels. A high-resolution image signal is projected in fine detail.

Off

If a signal that exceeds the panel resolution of this projector is input, the image is displayed according to the panel resolution of this projector.

Full HD

For a signal with a resolution of 1080i/1080p/WUXGA or higher.

WUXGA+

For a signal with a resolution that exceeds WUXGA. When projecting a high-resolution movie, you can project a high-definition image by using this setting with **Image Preset Mode**.



- You cannot select this setting when the **Aspect** setting is set to **Native** in the projector's **Signal** menu.
- When projecting from multiple projectors, select **Off** to unify each image.
- **Off** is ideal for projecting presentation materials from computers and so on.
- If you select **Full HD** or **WUXGA+**, the status corrected using the following function is canceled.
 - Edge Blending
 - Scale
 - Curved Surface
 - Point Correction
 - Corner Wall

When you change the **4K Enhancement** setting to **Off**, the settings return to their previous state.



- To minimize delays, select **Off**.
- If you select **Off**, you cannot set the other items in the **Image Enhancement** setting.
- After selecting **Preset 1** to **Preset 5**, you can fine tune each setting individually. The settings value in the preset option are overwritten.
- The settings value are overwritten separately when 4K Enhancement is enabled and disabled.

Image Preset Mode

Image > Image Enhancement > Image Preset Mode

You can set the **Image Enhancement** options as a batch using preset values.

The following settings are saved in the preset options.

- Frame Interpolation
- Deinterlacing
- Noise Reduction
- MPEG Noise Reduction
- Super-resolution
- Detail Enhancement

Frame Interpolation

Image > Image Enhancement > Frame Interpolation

You can play fast moving images smoothly by producing intermediate frames between the original frames.

If your resulting images contain noise, set to **Off**.



- You cannot select this setting in the following cases.
- **4K Enhancement** is enabled.
 - A signal with a resolution that exceeds WUXGA is input.
 - **Aspect** is set to **V-Zoom**.
 - **Scale** is set to **Auto** or **Manual**.
 - **Edge Blending** is set to **On**.
 - **Image Preset Mode** is set to **Off**.

Deinterlacing

Image > Image Enhancement > Deinterlacing

You can set whether or not to convert interlaced-to-progressive signals for certain video image types.

Off

For fast-moving video images.

Video

For most video images.

Film/Auto

For movies, computer graphics, and animation.



Setting is only displayed in the following cases.

- The current signal is interlaced signal (480i/576i/1080i).
- **Image Preset Mode** is enabled.

Noise Reduction

Image > Image Enhancement > Noise Reduction

You can reduce flickering in images when inputting progressive signals or progressive interlace signals.



You cannot select this setting in the following cases.

- **4K Enhancement** is enabled.
- A signal with a resolution that exceeds WUXGA is input.
- **Image Preset Mode** is set to **Off**.

MPEG Noise Reduction

Image > Image Enhancement > MPEG Noise Reduction

You can reduce the noise or artifacts seen in MPEG video.



You cannot select this setting in the following cases.

- **4K Enhancement** is enabled.
- A signal with a resolution that exceeds WUXGA is input.
- **Image Preset Mode** is set to **Off**.

Super-resolution

Image > Image Enhancement > Super-resolution

You can reduce blurring when projecting low resolution images.

Fine Line Adjust

Higher values enhance details such as hair or fabric patterns.

Soft Focus Detail

Higher values enhance the outline, background, and the other main parts of the objects in the image to show them clearly.



You cannot select this setting when the **Image Preset Mode** setting is set to **Off**.

Detail Enhancement

Image > Image Enhancement > Detail Enhancement

You can create a more emphatic texture and material feel of the image.

Strength

Higher values enhance the contrast.

Range

Higher values widen the range of detailed enhancement.



- Depending on the image, a highlight may be noticeable at the border between colors. If this bothers you, set a smaller value.
- You cannot select this setting when the **Image Preset Mode** setting is set to **Off**.

Reset (Image Enhancement)

Image > Image Enhancement > Reset

You can reset the settings on the **Image Enhancement** setting to their default preset settings.



You cannot select this setting when the **Image Preset Mode** setting is set to **Off**.

Scene Adaptive Gamma

☛ **Image > Advanced > Scene Adaptive Gamma**

You can adjust the coloring according to the scene, and obtains a more vivid image.

Higher values enhance the more the contrast.

Gamma

☛ **Image > Advanced > Gamma**

You can adjust the coloring by selecting one of the gamma correction values, or referring to a gamma graph. If you want to make finer adjustments, select **Customized**.

When you select a smaller value, you can reduce the overall brightness of the image to make the image sharper. When you select a larger value, the dark areas of images become brighter, but the color saturation for lighter areas may become weaker.



- Project a still picture to adjust the Gamma. You cannot adjust the Gamma correctly when projecting movies.
- If you set the **Color Mode** setting to **DICOM SIM** in the projector's **Image** menu, select the adjustment value according to the projection size.
 - If the projection size is 120 inches or less, select a small value.
 - If the projection size is 120 inches or more, select a large value.
- Medical images may not be reproduced correctly depending on your settings and screen specifications.

RGBCMY

☛ **Image > Advanced > RGBCMY**

You can adjust the Hue, Saturation, and Brightness of each color R (red), G (green), B (blue), C (cyan), M (magenta), Y (yellow) individually.

Dynamic Contrast

☛ **Image > Dynamic Contrast**

You can adjust the projected luminance based on the image brightness.

Dynamic Contrast

Set to **On** to automatically adjust the amount of light.

Response Speed

Select **High Speed** to adjust the amount of light as soon as the scene changes.

Black Level

Set the black level when the brightness level of the image signal is zero. When you select **0%**, the light source turns off.

Lights-Out Control

☛ Image > Lights-Out Control

You can set the light source to turn off automatically.

Lights-Out Control

Set to **On** to automatically turn off the light source when the signal level falls below the reference level for a set period of time.

Lights-Out Signal Level

Set the brightness level for the video signal being controlled. After turning off automatically, it turns on immediately when exceeding the specified image level.

Lights-Out Timer

Set the amount of time before automatically turning off the light source.

Reset (Image menu)

☛ Image > Reset

You can reset all adjustment values on the **Image** menu to their default settings.

Normally, the projector automatically detects and optimizes the input signal settings. If you need to customize the settings, you can use the **Signal** menu. The available settings depend on the currently selected input source. The settings are saved separately for each selected input source.

► Related Links

- "Resolution" [p.75](#)
- "Aspect" [p.75](#)
- "Tracking" [p.76](#)
- "Sync." [p.76](#)
- "Position" [p.76](#)
- "Auto Setup" [p.76](#)
- "Overscan" [p.76](#)
- "Blanking" [p.77](#)
- "Color Space" [p.77](#)
- "Dynamic Range" [p.77](#)
- "Video Range" [p.77](#)
- "EDID" [p.78](#)
- "Scale" [p.78](#)
- "Reset (Signal menu)" [p.78](#)

Resolution

☛ Signal > Resolution

You can set the input signal resolution.

Auto

Select to automatically identify the resolution of the input signal.

If not detected automatically using the **Auto** option, select the following options.

Wide

For wide screens.

Normal

For 4:3 or 5:4 screens depending on the connected computer.

Manual

You can specify the resolution. This is ideal when connected computer is fixed.



Setting is only displayed when the current source is Computer.

Aspect

☛ Signal > Aspect

The projector can display images in different width-to-height ratios called aspect ratios. Normally, the input signal from your video source determines the image's aspect ratio. However, for certain images you can change the aspect ratio to fit your screen.

Auto

Automatically sets the aspect ratio according to the input signal and the **Resolution** setting.

Normal

Displays images using the full projection area and maintains the aspect ratio of the image.

4:3

Converts the aspect ratio of the image to 4:3.

16:9

Converts the aspect ratio of the image to 16:9.

Full

Displays images using the full size of the projection area, but does not maintain the aspect ratio.

H-Zoom/V-Zoom

Displays images using the full width (H-Zoom) or full height (V-Zoom) of the projection area and maintains the aspect ratio of the image. Areas that exceed the edges of the projected screen are not projected.

Native

Displays images as is (aspect ratio and resolution are maintained). Areas that exceed the edges of the projected screen are not projected.



- Setting is only displayed when the current source is Computer or HDMI.
- Available only when the **Scale** setting is set to **Off** or the **Scale Mode** setting is set to **Full Display**.
 ● **Signal > Scale > Scale Mode**
- Set the **Screen Type** setting in the projector's **Extended** menu before changing the aspect ratio.
 ● **Extended > Display > Screen > Screen Type**
- To display images without black bars, set **Resolution** to **Wide** or **Normal** in the projector's **Signal** menu according to the computer's resolution.
- The available aspect ratio setting varies depending on the selected **Screen Type** setting and the input signal from your image source.
- Note that using the aspect ratio function of the projector to reduce, enlarge, or split the projected image for commercial purposes or for public viewing may infringe upon the rights of the copyright holder of that image based on copyright law.
- If there are margins between the edge of the image and the projected screen frame, you can adjust the position of the image using the **Screen Position** setting in the projector's **Extended** menu.
 ● **Extended > Display > Screen > Screen Position**
- You can change the projector's Aspect using the [Aspect] button on the remote control.

Tracking● **Signal > Tracking**

You can adjust the signal to eliminate vertical stripes in computer images.



Setting is only displayed when the current source is Computer.

Sync.● **Signal > Sync.**

You can adjust the signal to eliminate fuzziness or flickering in computer images.



Setting is only displayed when the current source is Computer.

Position● **Signal > Position**

You can adjust the image location on the screen.



Setting is only displayed when the current source is Computer.

Auto Setup● **Signal > Auto Setup**

Set to **On** to automatically optimize computer image quality.



Setting is only displayed when the current source is Computer.

Overscan● **Signal > Overscan**

You can change the projected image ratio to make the edges visible by a selectable percentage or automatically.



Setting is only displayed when the input signal is component signal.

Blanking

☛ Signal > Blanking

You can hide images in the specified area.

Use the arrow buttons on the control panel or remote control to adjust the area. You can hide up to half of the projected image in each direction (except for one pixel).



Setting is only displayed when the **Content Playback** setting is set to **Off** in the projector's **Settings** menu.

Color Space

☛ Signal > Color Space

You can switch the color space that can handle the color information of the input image.

Select **Auto** to apply a suitable color space for the AVI InfoFrame of the image.



Setting is only displayed in the following cases.

- The current source is HDMI, HDBaseT, DVI-D, or SDI (EB-PU2010B/EB-PU2010W).
- **Color Mode** is set to other than **BT.709** or **DICOM SIM**.

Dynamic Range

☛ Signal > Dynamic Range

You can set the video range to match the setting of input source.

Select **Auto** to automatically identify the dynamic range of the input signal.

The result for your selected setting is displayed as **Signal Status**.

HDR10 Setting

You can adjust the PQ curve of the dynamic range in the HDR PQ (Perceptual Quantizer) method.

HLG Setting

You can adjust the HLG curve of the dynamic range in the HDR HLG (Hybrid Log Gamma) method.



- Setting is only displayed in the following cases.
- The current source is HDMI, HDBaseT, or SDI (EB-PU2010B/EB-PU2010W).
- **Color Mode** is set to other than **BT.709** or **DICOM SIM**.
- **HDR10 Setting** is only available when **Signal Status** is set to **HDR10**.
- **HLG Setting** is only available when **Signal Status** is set to **HLG**.

Video Range

☛ Signal > Advanced > Video Range

You can set the video range to match the setting of input source from the HDMI, DVI-D, or HDBaseT port.

Limited (16-235)

For the brightness range 16 to 235.

Full (0-255)

For the brightness range 0 to 255.

EDID

☛ Signal > Advanced > EDID

Even if you setup multiple displays with different resolutions, you can set the same EDID as the standard display and switch the EDID of the current source to unify the EDID across the displays.

Preset EDID

You can set the **EDID** options as a batch using preset values.

The following settings are saved in the preset options.

- Resolution
- Refresh Rate
- Color Depth

You can change the preset settings if necessary.



- Setting is only displayed when the current source is HDMI, HDBaseT, or DVI-D.
- Select **Reset** to reset all adjustment values for EDID to their default values.

Scale

☛ Signal > Scale

☛ Extended > Multi-Projection > Scale

You can enlarge or reduce the image in the vertical and horizontal directions. When using multiple projectors to project one image, you can adjust the scale of the image displayed by each projector.

Scale

When set to **Auto**, the clip position is set automatically depending on the **Edge Blending** and **Tiling** settings. After selecting **Auto**, you can fine tune manually.

Select **Manual** to adjust the clip range and position manually.

Scale Mode

Select how to change the magnification.

- **Zoom Display** to maintain the image position and aspect ratio.
- **Full Display** to adjust the image according to the image position and aspect ratio.

Scale Horizontally/Scale Vertically

You can adjust the magnification horizontally and vertically in 0.01x increments, and enlarge or reduce the image. (Minimum magnification of 0.5 to maximum magnification of 10.)

Clip Adjustment

Use the arrow buttons to adjust the coordinates and size of each image as you view the screen.

Clip Range

You can view the clipped area you selected.

Reset (Signal menu)

☛ Signal > Reset

You can reset all adjustment values on the **Signal** menu to their default settings, except for the following:

- EDID

Options on the **Settings** menu let you customize various projector features.

► Related Links

- "Geometry Correction" p.79
- "Split Screen" p.80
- "Volume" p.81
- "HDMI Link" p.81
- "Control Panel Lock" p.81
- "Lens Lock" p.82
- "Light Source Mode" p.82
- "Brightness Level" p.82
- "Constant Brightness" p.82
- "Estimated Remains" p.82
- "Remote Receiver" p.84
- "User Button" p.84
- "Test Pattern" p.84
- "Memory" p.85
- "Content Playback" p.85
- "Reset (Settings menu)" p.87

Geometry Correction

☛ **Settings > Geometry Correction**

☛ **Extended > Multi-Projection > Geometry Correction**

☛ **Extended > Multi-Projection > Simple Stacking > Point Correction**

You can adjust image shape to rectangular. After correction, your image is slightly smaller.

You can check the available adjustment range in the projector's *Specifications*.

Off

Temporarily cancels geometry correction. Even when set to **Off**, the correction values are saved.

H/V-Keystone

Manually corrects distortion in the horizontal and vertical directions independently. If the image aspect is incorrect, adjust the image balance by using **V-Balance** and **H-Balance**.

You cannot combine with other correction methods.

Quick Corner

Corrects each of the four corners of the projected image independently.

Curved Surface

Corrects the corners and sides of an image projected on a curved surface with the same radius.



- Place the projector so it squarely faces the screen, not at an angle.
- Move the lens position to the home position.
- If a large amount of adjustment is performed, the focus may not be uniform even after making adjustments.
- If you set the **Maintain Aspect Ratio** setting to **On** after correcting the corrections may not be applied. Reset the corrections to their default values or reduce the amount of correction, and try it again.
- If you change the standard line during correcting, the present settings are reset.

Corner Wall

Corrects the corners and sides of an image projected on a curved surface with right angles.



- Place the projector so it squarely faces the screen, not at an angle.
- Move the lens position to the home position.
- If a large amount of adjustment is performed, the focus may not be uniform even after making adjustments.
- We recommend you adjust the image shape based on the point nearest to the center of the screen.

Point Correction

Divides the projected image into a grid and corrects the distortion in 0.5 pixel increments by moving the selected point of intersection in any

direction. You can move the points on the grid between 0.5 to 600 pixels in any direction, including outside the projection range.

Memory

You can save the shape of an image you have adjusted and load it when needed.



- You can also open the Geometry Correction screen using the [Geometry] button on the control panel or remote control.
- You can also open the Memory screen using the [Memory] button on the remote control.

Split Screen

Settings > Split Screen

You can simultaneously project two images from different image sources.

Screen Size

Select the screen size.



Depending on the video signals that are input, the images on the left and right may not appear to be the same size even if you select **Equal**.

Source

Select the input source.



- The following input source combinations cannot be projected on a split screen.
 - Computer and LAN
 - DVI-D and HDMI
- Input signals with a horizontal resolution exceeding 1920 are not supported.

Swap Screens

You can swap images that are being projected on the left and right.

Audio Source

Select the screen from which you want to hear audio.

When you select **Auto**, audio is output from the enlarged screen. If the screen sizes is set to **Equal**, audio is output from the screen on the left.



- While using the split screen feature, other projector features may not be available and some settings may be automatically applied to all images.
- You cannot perform split screen projection when the **Content Playback** setting is set to **On** in the projector's **Settings** menu.
- You can also open the Split Screen Setup screen using the [Split] button on the remote control.

» Related Links

- "Split Screen Projection Restrictions" [p.80](#)

Split Screen Projection Restrictions

Operating restrictions

The following operations cannot be performed during split screen projection.

- Setting the projector's menu
- E-Zoom
- Switching the aspect mode (the aspect mode is set to **Normal**)
- Operations using the [User] button on the remote control

Image restrictions

- If you make adjustments such as **Brightness**, **Contrast**, **Color Saturation**, **Tint**, and **Sharpness** in the projector's **Image** menu, you can apply them only to the image on the left. Default adjustments are applied to the image on the right. Adjustments that affect the entire projected image such as **Color Mode** and **Color Temp.** are applied for both left and right images.
- Even if you make adjustments for **Noise Reduction** and **Deinterlacing** in the projector's **Image** menu, **Noise Reduction** is set to 0 and **Deinterlacing** is set to **Off** for the image on the right.

☛ **Image > Image Enhancement > Noise Reduction**

- Even if you set **Display Background** to **Logo** in the projector's **Extended** menu, the blue screen appears when no image signal is being input.

Volume

Settings > Volume

You can control the speaker volume.

Caution

Do not start a presentation at a high volume setting. Sudden loud noises may cause hearing loss.

Always lower the volume before powering off, so that you can power on and then gradually increase the volume.

HDMI Link

Settings > HDMI Link

You can adjust the HDMI Link options that allow the projector remote to control HDMI-connected devices.

Device Connections

The devices connected to the HDMI ports are listed.

HDMI Link

Set to **On** to enable the HDMI Link features.

Audio Out Device

You can select whether to output audio from the internal speakers or a connected audio/video system.

Power On Link

You can control what happens when you turn on the projector or connected device.

- **Bidirectional:** automatically turns on the connected device when you turn on the projector, and vice versa.

- **Device -> PJ:** automatically turns on the projector when you turn on the connected device.
- **PJ -> Device:** automatically turns on the connected device when you turn on the projector.

Power Off Link

You can control whether connected devices are turned off when you turn off the projector.

Link Buffer

You can improve the performance of the linked operations by changing the settings if the HDMI Link function is not working correctly.



Set the **HDMI Link** setting to **On** first to adjust the options.

Control Panel Lock

Settings > Lock Setting > Control Panel Lock

You can control projector button locking to secure the projector.

Full Lock

All buttons locked.

Except for Power

All buttons except the [On] button locked.

Off

No buttons locked.



- You can control projector button locking using the control panel lock button on the control panel.
- To unlock the buttons, hold down the [Enter] button on the control panel for approximately 7 seconds. A message is displayed and the lock is released.

Lens Lock

☛ Settings > Lock Setting > Lens Lock

You can disable [Lens Shift], [Zoom], and [Focus] button operations on the remote control.

Light Source Mode

☛ Settings > Brightness Settings > Light Source Mode

You can select the brightness for the light source.

Normal

Maximum brightness. This makes the light source operation time approximately 20,000 hours.

Medium

85% brightness with fan noise louder than **Quiet**. This makes the light source operation time approximately 20,000 hours.

Quiet

70% brightness with reduced fan noise. This makes the light source operation time approximately 20,000 hours.

Extended

70% brightness and extends the life expectancy of the light source. This makes the light source operation time approximately 30,000 hours.

Custom

You can select a custom brightness level.



Setting is only displayed when **Constant Brightness** is set to **Off**.

☛ Extended > Multi-Projection > Screen Matching > Brightness Settings > Brightness Level

You can select the **Custom** brightness level you want.



Setting is only displayed when **Light Source Mode** is set to **Custom**.

Constant Brightness

☛ Settings > Brightness Settings > Constant Brightness

You can maintain the brightness of the light source set in the **Brightness Level** setting.



- Setting is only displayed when **Light Source Mode** is set to **Custom**.
- When set to **On**, you cannot change the settings for **Light Source Mode** and **Brightness Level**.
- When set to **Off**, the **Brightness Level** setting changes according to the status of the light source.

Estimated Remains

☛ Settings > Brightness Settings > Estimated Remains

You can check how long the projector can maintain constant brightness.



Setting is only displayed when **Constant Brightness** is set to **On**.

Brightness Level

☛ Settings > Brightness Settings > Brightness Level

» Related Links

- "Constant Brightness Usage Hours" [p.83](#)
- "Light Source Operation Time" [p.83](#)

Constant Brightness Usage Hours

If you turn on **Constant Brightness**, the number of hours the projector can maintain constant brightness is displayed as **Estimated Remains**.

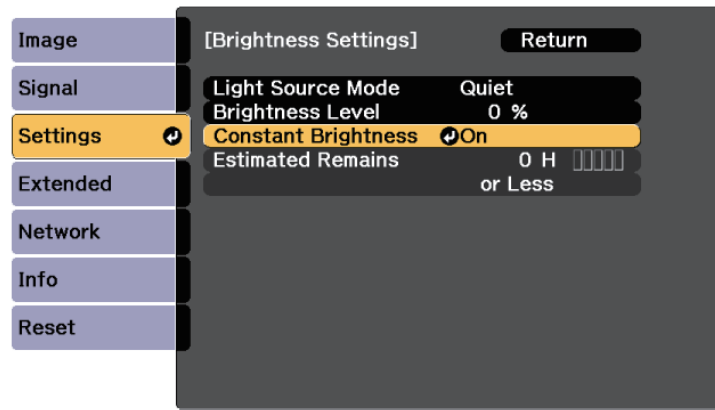

The number of hours displayed as **Estimated Remains** is just a guide.

Light Source Operation Time

The light source operation time varies depending on the **Brightness Level** setting and whether **Constant Brightness** is on or off.



- The light source operation time varies depending on the environmental conditions and usage.
- The hours listed here are an approximate and are not guaranteed.
- You may need to replace internal parts sooner than the estimated light source operation time.
- If **Constant Brightness** is turned on, and you have exceeded the usage hours listed here, you may not be able to select a high **Brightness Level** setting.

Display level	Estimated remaining hours
	10,000 or more hours
	8,000 to 9,999 hours
	6,000 to 7,999 hours
	4,000 to 5,999 hours
	2,000 to 3,999 hours
	0 to 1,999 hours

Constant Brightness off

Brightness Level setting	Time before the brightness of the light source is reduced by half (approximate)
100%	20,000 hours
90%	21,000 hours
80%	24,000 hours
70%	30,000 hours
60%	37,000 hours
50%	47,000 hours
40%	61,000 hours
30% or less	71,000 hours or more

Constant Brightness on

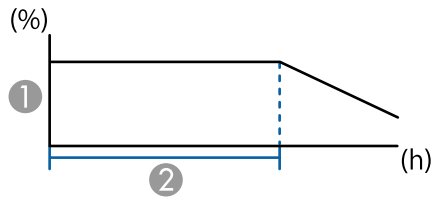

- ① Brightness level
- ② Time the projector can maintain constant brightness (approximate)

Brightness Level setting	Time the projector can maintain constant brightness (approximate)
85%	6,000 hours
80%	10,000 hours
70%	19,000 hours
60%	29,000 hours
50%	41,000 hours
40%	56,000 hours
30% or less	78,000 hours or more



You can turn on all remote receivers by holding down the [Menu] button on the remote control for approximately 15 seconds.

User Button

☛ Settings > User Button

You can assign the following menu options to the [User] buttons on the remote control for one-touch access.

- Light Source Mode
- Multi-Projection
- Resolution
- On-Screen Display
- Display the QR Code
- Image Enhancement
- Frame Interpolation
- Link Menu
- Content Playback
- USB



The USB option is only displayed when **Content Playback** is set to **On**.

Remote Receiver

☛ Settings > Remote Receiver

When the remote control does not operate stably due to noise from other devices, you can limit reception of remote control signals to the selected receiver; **Off** turns off all receivers.

Test Pattern

☛ Settings > Test Pattern

You can display a test pattern to assist in focusing and zooming the image and correcting image shape.



- Press the [Page] button to change the test pattern while displaying a test pattern.
- Press the [Esc] button to cancel pattern display.
- The test pattern's shape is determined by the **Screen Type** setting. Be sure to set the correct screen type before adjusting with the test pattern.
 - ☛ **Extended > Display > Screen > Screen Type**
- To set menu items that cannot be set while the test pattern is being displayed or to fine-tune the projected image, project an image from the connected device.
- You can also display a test pattern using the [Test Pattern] button on the control panel or remote control.

Memory

☛ Settings > Memory

You can save customized settings and then select the saved settings whenever you want to use them.

Memory

You can save the following settings. You can register up to 10 memories with different names.

- **Image** menu settings
- **Scale** in the **Signal** menu
- **Light Source Mode** and **Brightness Level** in the **Settings** menu
- **Edge Blending**, **Color Matching**, and **Black Level** in the **Extended** menu

Lens Position

You can save the position of the lens adjusted using lens shift, zoom, focus, and distortion. You can register up to 10 memories with different names.

Geometry Correction

You can save the adjustment value of the geometry correction. You can register up to 3 memories with different names.

You can use the following options for each memory type.

Load Memory

You can load the saved memory. The settings applied to the current image are replaced with the settings in the memory.

Save Memory

You can save your current settings to memory.

Erase Memory

You can erase the selected memory settings.

Rename Memory

You can rename a saved memory.

Reset Memory Settings

You can delete all saved memories.



- A memory name that has already been used is indicated by a blue mark. Saving over a previously saved memory overwrites the settings with your current settings.
- The lens position when a memory is loaded may not completely match the lens position when the memory was saved. If there is a large discrepancy between the lens position, calibrate the lens.
- You can also open the Memory screen using the [Memory] button on the remote control.

Content Playback

☛ Settings > Content Playback > Content Playback

You can easily project your digital signage content: playlists that contain images and movies saved on an external storage device.

Content Playback

Set to **On** to play back a playlist.

Overlay Effect

You can add color and shape effects to the projected image.

USB Viewer

You can select and play back a playlist saved on the USB flash drive.



- You cannot select the **Overlay Effect** setting in the following cases.
 - When **Edge Blending** is set to **On** in the projector's **Extended** menu.
 - When the current source is USB and there is no playlist being played.
 - When the current source is USB and an unwritable error has occurred.
- You can use the following methods to create playlists.
 - Using Epson Projector Content Manager on your computer. You can download and install Epson Projector Content Manager from the following Web site.
epson.sn
 - Using Epson Web Control with a Web browser.
 - Using Epson Creative Projection on iOS devices. You can download Epson Creative Projection from the App Store. Any fees incurred when communicating with the App Store are the responsibility of the customer.
- Press the [USB] button on the remote control to project the playlist. If there is a timetable assigned, the playlist will play back according to the schedule in the timetable.
- You can also hold down the [Num] and numeric buttons to project your favorite playlist. You can set a remote control shortcut key using the software you used to create the playlists.

» Related Links

- "Creating Playlists Using Epson Web Control" [p.86](#)
- "Content Playback Mode Restrictions" [p.87](#)

Creating Playlists Using Epson Web Control

In Content Playback mode, you can create playlists using a Web browser and save them to a USB flash drive connected to a projector on a network.

Attention

Do not remove the USB flash drive from the projector or disconnect the projector's power cord while creating playlists. Data saved on the USB flash drive may be damaged.

- Make sure the projector is operating in Content Playback mode.
- Make sure your computer or device is connected to the same network as the projector.
- Make sure a USB flash drive is connected to the projector's USB-A port.
- Start your Web browser on your computer or device.
- Go to the Epson Web Control screen by entering the projector's IP address into the browser's address box. When entering an IPv6 address, wrap the address with [and].
- Select **USB Memory Device**.
- Select **Upload New Data**.
- Select the images or movies you want to add to the playlist.



You can upload .avi, .jpeg (.jpg), .png, .bmp, or .gif files. If you want to add .mp4 or .mov files to the playlist, use the Epson Projector Content Manager software or the Epson Creative Projection app.

The selected files are copied to the connected USB flash drive.

- Do one of the following:
 - To add them to the existing playlist, select **Add to Playlist** and select the playlist you want to add them to.
 - To create a new playlist and add them to it, select **Create New Playlist**.
- Edit the playlist.
- When you have finished editing the playlist, select **Finish**.



- See the section in this guide covering Web Control Options for details.
- You can play the playlist from the **Remote** or **Playlist** screen.
- When you want to specify when the playlist starts and finishes, schedule the playlist using the Epson Projector Content Manager software.

» Related Links

- "Epson Web Control" [p.125](#)

Content Playback Mode Restrictions

Operating restrictions

The following operations cannot be performed in Content Playback mode.

- Changing the **Color Temp.** setting in the **Image** menu (when **Warm White** or **Cool White** is selected as **Color Filter**)
- Split Screen
- Blanking
- Changing the **Display Background** setting in the **Extended** menu
- Changing the **Screen** setting in the **Extended** menu
- Changing the **Log Save Destination** setting in the **Extended** menu
- Using **Edge Blending** with **Effects** feature
- Detecting the input signal automatically

Reset (Settings menu)

☛ Settings > Reset

You can reset all adjustment values on the **Settings** menu to their default settings, except for the following:

- Audio Out Device
- Power On Link

- Power Off Link
- Link Buffer
- User Button

Settings on the **Extended** menu let you customize various projector setup features.

► Related Links

- "Home Screen" [p.88](#)
- "Menu Position" [p.88](#)
- "Message Position" [p.89](#)
- "Messages" [p.89](#)
- "Display Background" [p.89](#)
- "Startup Screen" [p.89](#)
- "Standby Confirmation" [p.89](#)
- "Air Filter Notice" [p.89](#)
- "Screen" [p.89](#)
- "Panel Alignment" [p.90](#)
- "Color Uniformity" [p.90](#)
- "OSD Rotation" [p.91](#)
- "User's Logo" [p.91](#)
- "Projection" [p.91](#)
- "Direct Power On" [p.91](#)
- "Sleep Mode" [p.92](#)
- "Sleep Mode Timer" [p.92](#)
- "High Altitude Mode" [p.92](#)
- "Auto Source Search" [p.92](#)
- "Auto Power On" [p.92](#)
- "Startup Source" [p.92](#)
- "Quick Startup" [p.92](#)
- "USB Power" [p.93](#)
- "A/V Mute Settings" [p.93](#)
- "Beep" [p.93](#)
- "Indicators" [p.93](#)
- "Log Save Destination" [p.93](#)
- "Batch Setup Range" [p.93](#)
- "AC Voltage Monitoring" [p.94](#)
- "Lens Type" [p.94](#)
- "Date & Time" [p.94](#)
- "Lens Calibration" [p.94](#)
- "A/V Settings" [p.94](#)
- "Standby Mode" [p.95](#)

- "HDBaseT" [p.95](#)
- "Color Calibration" [p.95](#)
- "Projector ID" [p.96](#)
- "Projector Grouping" [p.96](#)
- "Tiling" [p.96](#)
- "Edge Blending" [p.96](#)
- "Black Level" [p.97](#)
- "Reset (Multi-Projection menu)" [p.97](#)
- "Screen Matching" [p.97](#)
- "Color Matching" [p.98](#)
- "Simple Stacking" [p.98](#)
- "Schedule Settings" [p.99](#)
- "Language" [p.100](#)
- "Reset (Extended menu)" [p.100](#)

Home Screen

☛ Extended > Home Screen

You can adjust settings on the Home screen.

Home Screen Auto Disp.

Set to **On** to display the Home screen automatically when there is no input signal when turning on the projector.

Custom Function 1/Custom Function 2

Select menu options to be assigned to the Home screen.

Menu Position

☛ Extended > Display > Menu Position

You can select the position of the projector menu displayed on the screen.

Message Position

☛ Extended > Display > Message Position

You can select the position of messages displayed on the screen.

Messages

☛ Extended > Display > Messages

You can control whether messages are displayed on the screen.

Display Background

☛ Extended > Display > Display Background

You can select the screen color or logo to display when no signal is received.



Setting is only displayed when **Content Playback** is set to **Off**.

Startup Screen

☛ Extended > Display > Startup Screen

You can control whether a special screen appears when the projector starts up.



This function is disabled when you turn on the projector in **Quick Startup** mode.

Standby Confirmation

☛ Extended > Display > Standby Confirmation

You can display a confirmation message after pressing the [Standby] button on the remote control.

When set to **Off**, you can turn off the projector simply by pressing the [Standby] button once.

Air Filter Notice

☛ Extended > Display > Air Filter Notice

You can display a message when a clog in the air filter is detected.

Screen

☛ Extended > Display > Screen

You can set the aspect ratio and position of the projected image according to the type of screen being used.

Screen Type

Set the aspect ratio of the screen to fit the image into the projection area.

Screen Position

You can shift the image position horizontally and vertically if there are margins between the edge of the image and the projected screen frame due to the **Screen Type** setting.



- Adjust the aspect ratio for the projected image, if necessary.
- When the **Screen Type** setting changes, the **EDID** settings are automatically adjusted.
- Settings are only displayed when **Content Playback** is set to **Off**.
- This setting is unavailable when projecting images from a computer over a network.
- The **Screen Type** setting is not supported by the Message Broadcasting feature in the Epson Projector Management software.
- You cannot adjust the screen position if you set the **Screen Type** setting to the same aspect ratio as the projector resolution.

- **Shift the whole panel** to adjust the whole panel roughly.
- **Adjust the four corners** to adjust the four corners of the panel precisely. If you need to make additional adjustments, select **Select intersection and adjust** to adjust more precisely.

Reset

You can reset all adjustment values on the **Panel Alignment** menu to their default settings.



- Image quality may decline after performing alignment.
- Images for pixels that extend beyond the edge of the projected screen are not displayed.

Panel Alignment

☛ Extended > Display > Panel Alignment

You can use the panel alignment feature to manually adjust the color convergence (the alignment of the red and blue colors) in the projected image. You can adjust the pixels horizontally and vertically in increments of 0.125 pixels within a range of ± 3 pixels.

Panel Alignment

Set to **On** to correct color misalignment in the projected image.

Select Color

Select the color you want to adjust.

Pattern Color

Select the grid color displayed during adjustments.

- **R/G/B** to display the grid color in white.
- **R/G** to display the grid color in yellow.
- **G/B** to display the grid color in cyan.

The available color varies depending on the **Select Color** setting.

Start Adjustments

Starts the panel alignment process.

The image may become distorted while adjusting. The image is restored once adjustments are complete.

Color Uniformity

☛ Extended > Display > Color Uniformity

☛ Extended > Multi-Projection > Screen Matching > Color Uniformity

You can use the color uniformity feature to manually adjust the color tone balance in the projected image.

Color Uniformity

Set to **On** to adjust the color tone balance for the whole screen.

Adjustment Level

Select the adjustment level you want to adjust.

There are eight adjustment levels, from white to gray to black. Adjust each level individually.

Set to **All** to adjust the tint for each color from level 2 to 8 in a batch. (Once the values of red, blue, or green are at maximum or minimum at any level, you cannot perform further adjustments.)

Start Adjustments

Starts adjustments for the selected adjustment level.

The image may become distorted while adjusting. The image is restored once adjustments are complete.

Adjust the outer areas first, and then adjust the entire screen.

Reset

You can reset all adjustment values on the **Color Uniformity** menu to their default settings.



The color tone may not be uniform even after adjusting the color uniformity.

OSD Rotation

☛ **Extended > Display > OSD Rotation**

You can rotate the menu display 90°.

User's Logo

☛ **Extended > User's Logo**

You can save an image on the projector and display it whenever the projector turns on. You can also display the image when the projector is not receiving an input signal. This image is called the user's logo screen.

You can select a photo, graphic, or company logo as the user's logo, which is useful in identifying the projector's owner to help deter theft. You can prevent changes to the user's logo by setting up password protection.

Display the image you want to project as the user's logo and then select this setting.



- If the **User's Logo Protection** setting in the **Password Protection** setting menu is set to **On**, set to **Off** before saving the user's logo.
- When you copy the menu settings from one projector to another using the batch setup feature, user's logo is also copied. Do not register the information that you do not want to share between multiple projectors as a user's logo.
- You cannot save content that is protected by HDCP.
- When **Content Playback** is set to **On**, you can display the user's logo only when the projector starts up.
- Adjustments for image shape and display range are temporarily canceled when you select **User's Logo**.

Projection

☛ **Extended > Projection**

You can set the way the projector faces the screen so the image is oriented correctly.



You can change the projection mode to flip the image over top-to-bottom by holding down the [A/V Mute] button on the remote control for approximately 5 seconds.

Direct Power On

☛ **Extended > Operation > Direct Power On**

Set to **On** to turn on the projector by plugging it in without pressing the power button.

Note that the projector also turns on automatically in cases such as recovery from a power outage.

Sleep Mode

☛ Extended > Operation > Sleep Mode

Set to **On** to automatically turns off the projector after an interval of inactivity.

Set to **On** to detect the input signal automatically and project images when there is no input signal.



- Setting is only displayed when **Content Playback** is set to **Off**.
- This function is disabled when you turn on the projector in the **Quick Startup** mode.

Sleep Mode Timer

☛ Extended > Operation > Sleep Mode Timer

You can set the time before the projector automatically turns off from 1 to 30 minutes.



Sleep Mode must be turned on.

Auto Power On

☛ Extended > Operation > Auto Power On

Set to **Computer** to automatically turns on the projector when it detects an input signal from the image source.

High Altitude Mode

☛ Extended > Operation > High Altitude Mode

When operating the projector at an altitude where the air is thin, the normal rotation speed of the fans is not enough to cool the projector.

Set to **On** to increase the rotation speed of the fans at altitudes above 1500 m.

Startup Source

☛ Extended > Operation > Startup Source

You can select the image source you want to project when the projector is turned on in Content Playback mode.



When set to **On**, the projector's operating temperature will rise.

Quick Startup

☛ Extended > Operation > Quick Startup

You can set the time period for Quick Startup mode. The projector enters this mode when you turn it off. You can start projecting in approximately 7 seconds by pressing the power button.



Set **A/V Output** to **While Projecting** first.

Auto Source Search

☛ Extended > Operation > Auto Source Search

USB Power

☛ Extended > Operation > USB Power

Set to **Always On** to continue supplying power to the streaming media player when the projector is not projecting images. This lets the streaming media player start earlier, or perform its firmware updates automatically over a network if necessary.



Set **A/V Output** to **While Projecting** first.

A/V Mute Settings

☛ Extended > Operation > A/V Mute Settings

You can adjust the A/V Mute settings.

Fade-in

Set the number of seconds for a fade-in transition effect when displaying an image.

Fade-out

Set the number of seconds for a fade-out transition effect when hiding an image.

A/V Mute Timer

Turns off the projector automatically if **A/V Mute** is enabled and 2 hours of inactivity has passed.

Release A/V Mute

Select **A/V Mute** if you want to use only the [A/V Mute] button to turn off A/V mute or if you want to send a command to turn off A/V Mute, or select **Any Button** to use any button to turn it off.

Beep

☛ Extended > Operation > Advanced > Beep

You can control the beep that sounds when you turn the projector on or off.

Indicators

☛ Extended > Operation > Advanced > Indicators

Set to **Off** to turn off the indicator lights on the projector except when an error or warning occurs.

Log Save Destination

☛ Extended > Operation > Advanced > Log Save Destination

You can set where you want to save the operation logs for the projector.

Select **USB and Internal Memory** to save logs as text files (.log) to a USB flash drive inserted into the projector's USB-A port.



Setting is only displayed when **Content Playback** is set to **Off**.

Batch Setup Range

☛ Extended > Operation > Advanced > Batch Setup Range

You can select which menu settings you want copied.

All

Select this to copy all of the projector menu settings using the batch setup feature.

Limited

Select this if you do not want to copy the **EDID** and **Network** menu settings.

AC Voltage Monitoring

☛ **Extended > Operation > Advanced > AC Voltage Monitoring**

Set to **On** to monitor the projector's voltage status and obtain a log when a warning, disconnection, or power blockage occurs.

If you regularly turn off the projector by turning off the power outlet (direct shutdown), set to **Off**.



You can view the log in the projector's **Info** menu.

☛ **Info > Voltage Warning Info**

Lens Type

☛ **Extended > Operation > Advanced > Lens Type**

Select the model number for the attached lens when using the following lenses:

- ELPLS04
- ELPLU02/ELPLU03S/ELPLU04
- ELPLR04
- ELPLW04/ELPLW05/ELPLW06/ELPLW08
- ELPLM06/ELPLM07/ELPLM08/ELPLM09/ELPLM15/ELPLM10/ELPLM11
- ELPLL07/ELPLL08

Date & Time

☛ **Extended > Operation > Date & Time**

You can adjust the projector's system time and date settings.

Daylight Saving Time

Adjust the daylight saving time settings for your region.

Internet Time

Turn on this setting to update the date and time automatically through an Internet time server.



When you set **Schedule Protection** to **On** in the **Password Protection** screen, you cannot change the time and date settings. Set **Schedule Protection** to **Off** first.

Lens Calibration

☛ **Extended > Operation > Lens Calibration**

You can view information about the lens currently in use.

It takes up to approximately 100 seconds. When calibration is finished, the lens returns to the same position it was in before calibration.

The following lenses return to the standard position.

- ELPLX01/01S
- ELPLX01W/01WS
- ELPLX02/02S
- ELPLX02W/02WS

A/V Settings

☛ **Extended > A/V Settings**

You can select to output audio and video to an external device when the projector is in standby mode.

Select **Always On** to output audio and images to external devices when the projector does not project any images.



- Available only when **Quick Startup** is set to **Off**.
- When set to **Always On**, you can move the lens position to the home position even if the projector is in standby mode.
- When set to **Always On**, communication from the HDBaseT port is enabled.



- **Control Communications** is only displayed when **Extron XTP** is set to **Off**.
- When **Extron XTP** is set to **On**, the cooling fans may run even in standby status. This is not a malfunction.

Standby Mode

☛ Extended > Standby Mode

Set to **Communication On** to monitor and control the projector over a network.



Setting is only displayed when **A/V Output** is set to **While Projecting**.

HDBaseT

☛ Extended > HDBaseT

You can select the communication settings for connections to an HDBaseT transmitter or switcher.

Control Communications

You can enable or disable communication from the Ethernet and serial ports on the HDBaseT transmitter or switcher; set to **On** to disable the projector's LAN, RS-232C, and Remote ports.

Extron XTP

Set to **On** when you connect an Extron XTP transmitter or switcher to the **HDBaseT** ports. See the following Extron Web site for more details on the XTP system.

<http://www.extron.com/>

Color Calibration

☛ Extended > Color Calibration

The color calibration process adjusts the color balance and brightness that has deteriorated over time based on images taken by the optional external camera, and restores the default image quality.

Color Calibration

Set to **On** to enable the color calibration process.

Start Auto Adjustment

Starts auto adjustment.

Undo

You can undo auto adjustment.

Redo

Select after selecting **Undo** to restore the image to the status after auto adjustment.

Color Uniformity

You can adjust the color tone balance for the whole image.

Reset

You can reset all adjustment values on the **Color Calibration** menu to their default settings.

▶▶ Related Links

- "Conditions for Color Calibration" [p.95](#)

Conditions for Color Calibration

You can use the color calibration feature under the following conditions:

- The optional external camera is installed on each projector.

- You are projecting on a matte white diffusion screen that is flat and even.
- The projector is placed so it squarely faces the screen, not at an angle.
- Nothing is blocking the optional external camera and the projected image.
- Projection size is between 80 to 200 inches.

Projector ID

☛ Extended > Multi-Projection > Projector ID

You can set the projector to a particular ID number which allows you to use a remote control to individually control projectors. This is useful when you want to control multiple projectors using one remote control.



- You need to set the remote control's ID to match the projector's ID to operate only a particular projector. To set the remote control's ID, set the remote control [ID] switch to **On**. Press the [ID] button on the remote control and press the numeric button that matches the projector's ID within 5 seconds. (Enter a one-digit or two-digit number.)
- If you do not know the projector's ID, press the [ID] button during projection to temporarily display the projector's ID and the remote control's ID on the screen.
- You can set up to 30 IDs.

Projector Grouping

☛ Extended > Multi-Projection > Projector Grouping

You can create a group of projectors that you can control simultaneously.

Tiling

☛ Extended > Multi-Projection > Tiling

You can project the same image from up to 9 projectors to create one large image using the Tiling feature.

Tiling

Set to **Auto** to configure tiling automatically.

If you do not install the optional external camera or tiling the images automatically was unsuccessful, select **Manual**, and then select the **Layout** and **Location Setup** settings individually.

Layout

Select the number of rows and columns you are setting up.

Location Setup

Select the position of each projected image as follows:

- **Row Order** to layout the screens from top to bottom, starting with 1 at the top, in sequential order.
- **Column Order** to layout the screens from left to right, starting with A on the left, in alphabetical order.

Location Info

You can view the name, IP address, and ID of the projector you set.



- **Auto** is available only when the optional external camera is installed.
- Make sure nothing is blocking the optional external camera while performing automatic tiling.
- Do not change any of the projector names or IP addresses, or the images will not be adjusted automatically.

Edge Blending

☛ Extended > Multi-Projection > Edge Blending

You can blend the border between multiple images to create a seamless screen.

Edge Blending

Set to **On** to enable the Edge Blending feature.

When not projecting images from multiple projectors, select **Off**.

Top Edge/Bottom Edge/Right Edge/Left Edge

Select the edge you want to blend on each projector.

- **Blending** to turn on the Edge Blending feature for the selected edge. Gradation is applied to the blending range.
- **Blend Start Position** to adjust the point where edge blending begins in 1 pixel increments. The blending start position is displayed with a red line.
- **Blend Range** to select the width of the blended area in 1 pixel increments. You can select up to 45% of the projector's resolution.
- **Blend Curve** to select a gradient for the shaded area on the projected image.

Line Guide

Set to **On** to display a guide on the blended area.

Pattern Guide

Set to **On** to display a grid to match the blended area.

Guide Color

Select a combination of guide colors.



Set the **Color Mode** setting to **Multi-Projection** in the projector's **Image** menu for all of the projectors.

Black Level

☛ **Extended > Multi-Projection > Black Level**

☛ **Extended > Multi-Projection > Screen Matching > Black Level**

You can adjust the brightness and tone differences in overlapping images.

Color Adjustment

You can adjust the brightness and tone of the areas. The adjustment areas are displayed based on the **Edge Blending** setting.

When multiple screens are overlapping, adjust overlapping areas starting with the brightest areas first. Adjust the non-overlapping area (darkest part) last.

Area Correction

If the tone for some areas does not match, you can adjust it individually.

Reset

You can reset all adjustment values on the **Black Level** menu to their default settings.



- You cannot adjust the **Black Level** setting when a test pattern is displayed.
- If the **Geometry Correction** value is very large, you may not be able to adjust the **Black Level** correctly.
- The brightness and tone may differ in areas where the images overlap as well as in other areas even after performing **Black Level** adjustment.
- If you change the **Edge Blending** setting, the **Black Level** setting returns to its default value.
- Available only when at least one of **Top Edge**, **Bottom Edge**, **Left Edge**, and **Right Edge** are set to **On** in the **Edge Blending** settings.

Reset (Multi-Projection menu)

☛ **Extended > Multi-Projection > Reset**

You can reset all adjustment values on the **Multi-Projection** menu to their default settings.

Screen Matching

☛ **Extended > Multi-Projection > Screen Matching**

You can adjust the tint, brightness, black level, and blend curve of multiple projectors so that they match better.

If your projectors are on a network, the brightness and tint for multiple projectors are corrected automatically based on the darkest projector.

If your projectors are not on a network or automatic adjustment was unsuccessful, you can adjust the tint and brightness of multiple projectors manually.



- The auto adjustment feature is only available under the following conditions.
 - When you set the position of each image
 - When **Color Calibration** is set to **On**
- You can undo or redo the screen matching procedure only when **Light Source Mode** is set to **Custom**.
- The required time for screen matching varies depending on the projector layout. It takes up to approximately 18 minutes.

► Related Links

- "Conditions for Screen Matching" [p.98](#)

Conditions for Screen Matching

You can use the screen matching feature under the following conditions:

- All of the projectors are the same model and the optional external camera is installed on each projector.
- You are projecting on a matte white diffusion screen that is flat and even.
- The projector is placed so it squarely faces the screen, not at an angle.
- Nothing is blocking the optional external camera and the projected image.
- More than 20 minutes have passed after turning on the projector.
- The projectors to be adjusted are grouped.
- The projected images do not overlap or have gaps between them, and create a rectangular image after tiling.
- Projection size is between 80 to 200 inches.
- All the projectors are connected to the same network and project images with the same resolution.
- The Blend Range setting is set between 15 to 45%.
- **Projection** in the projector's **Extended** menu is set to **Front** or **Front/Ceiling** for all projectors.

Color Matching

☛ Extended > Multi-Projection > Screen Matching > Color Matching

You can adjust the tint and brightness for the color tone from white to black. During color matching, half of the overlapped area is displayed in black so that you can check the edge of the image easily.

Adjustment Level

Select the adjustment level you want to adjust.

There are eight adjustment levels, from white to gray to black. Adjust each level individually.

Set to **All** to adjust the tint for each color from level 2 to 8 in a batch. (Once the values of red, blue, or green are at maximum or minimum at any level, you cannot perform further adjustments.)

Red/Green/Blue

You can adjust the tone for each color.

Brightness

You can adjust the image brightness.

Simple Stacking

☛ Extended > Multi-Projection > Simple Stacking

You can easily and quickly create a bright projected image by overlapping the images of multiple projectors.

Point Correction

Divides the projected image into a grid and corrects the distortion in 0.5 pixel increments by moving the selected point of intersection in any direction. You can move the points on the grid between 0.5 to 600 pixels in any direction, including outside of the projection range.

Start Auto Adjustment

You can automatically adjust the projected image using the camera assist functions.

The projector for which you perform this feature becomes a master projector, and the adjustment is performed based on the projector's image position and shape.



- Connect two projectors using a LAN cable.
- Make sure you do the following before adjusting:
 - Set the **DHCP** setting to **On** in the projector's **Network** menu for two projectors.
 - ☛ **Network > Network Configuration > Wired LAN > IP Settings**
 - Adjust the image position, shape, and focus on the master projector. If you adjust the image shape of the master projector, select **Point Correction** and select **Quick Corner** to correct the shape.
- The required time for simple stacking varies depending on the projector layout. It takes up to approximately 4 minutes.

» **Related Links**

- "Conditions for Simple Stacking" [p.99](#)

Conditions for Simple Stacking

You can use the simple stacking feature under the following conditions:

- All of the projectors are the same model and the optional external camera is installed on each projector.
- Wait for 2 minutes after turning on two projectors before starting the simple stacking process.
- You are projecting on a matte white diffusion screen that is flat and even.
- The projector is placed so it squarely faces the screen, not at an angle.
- Nothing is blocking the optional external camera and the projected image.
- The projection size is within the following range according to the brightness of the light source (when the screen illuminance is 40 lux or less).
 - Up to 9.9 Klm: 50 to 200 inches
 - 10 Klm: 60 to 300 inches
- All the projectors are projecting images at the same resolution.

- The illuminance ratio on the screen surface when projecting an all-white screen and when projecting an all-black screen is 8:1 or more.
- **Projection** in the projector's **Extended** menu is set to **Front** or **Front/Ceiling** for all projectors.

Schedule Settings

☛ **Extended > Schedule Settings**

☛ **Extended > Multi-Projection > Screen Matching > Schedule Settings**

You can schedule various projector tasks.

Schedule Settings

Select **Add New** to schedule events. To save your events, select **Setup complete** and then select **Yes**.

- **Event Settings** to select the event details you want to perform. Select **No Change** for items that you do not want to change when the event occurs.
- **Date / Time Settings** to select the date and time at which you want the event to occur. You can schedule events up to 4 weeks later.

Schedule Reset

You can delete all scheduled events. To delete events completely, you need to select **Setup complete** and select **Yes**.

Setup complete

Saves your changes in the **Schedule Settings** menu.









- In the **Schedule** menu, you can schedule up to 30 events.
- In the **Extended Schedule** menu, you can schedule only one event for **Color Calibration** or **Screen Matching**.
- Light Source Calibration events do not start if the projector is used continuously for more than 24 hours, or regularly turned off by turning off the power outlet. Set the following events:
 - Turning on the projector 20 minutes before performing light source calibration.
 - Performing light source calibration periodically.

» **Related Links**

- "Schedule Status Icons" [p.100](#)

Schedule Status Icons

The icons in the calendar are described in the following table.

	Valid schedule
	Regular schedule
	Invalid schedule
	One time schedule
	Regular schedule
	Standby schedule (turns communication on or off during standby)
	Invalid schedule

- Auto Source Search
- USB Power
- Release A/V Mute
- Lens Type
- A/V Settings
- Standby Mode
- HDBaseT
- Projector ID
- Language



When you set **User's Logo Protection** to **On** in the **Password Protection** screen, you cannot change the following settings related to user's logo display. Set **User's Logo Protection** to **Off** first.

- Display Background
- Startup Screen

Language

☛ **Extended > Language**

You can select the language for projector menu and message displays.

Reset (Extended menu)

☛ **Extended > Reset**

You can reset all adjustment values on the **Extended** menu to their default settings, except for the following:

- Point Correction (in the Simple Stacking menu)
- Screen
- Projection
- High Altitude Mode

Settings on the **Network** menu let you view network information and set up the projector for controlling over a network.

When you set **Network Protection** to **On** from the **Password Protection** screen, you cannot change the network settings. Hold down the [Freeze] button for more than 5 seconds to turn off the **Network Protection** setting.

► Related Links

- "Wireless Mode" [p.101](#)
- "Net. Info. - Wireless LAN" [p.101](#)
- "Net. Info. - Wired LAN" [p.102](#)
- "Display the QR Code" [p.102](#)
- "Remote Camera Access" [p.102](#)
- "Projector Name" [p.102](#)
- "PJLink Password" [p.102](#)
- "Remote Password" [p.102](#)
- "Web Control Password" [p.102](#)
- "Moderator Password" [p.102](#)
- "Projector Keyword" [p.103](#)
- "Display Keyword" [p.103](#)
- "Display LAN Info." [p.103](#)
- "Connection Mode" [p.103](#)
- "Search Access Point" [p.103](#)
- "SSID" [p.104](#)
- "Security" [p.104](#)
- "Passphrase" [p.104](#)
- "EAP Method" [p.104](#)
- "Channel" [p.105](#)
- "IP Settings" [p.105](#)
- "SSID Display" [p.106](#)
- "IP Address Display" [p.106](#)
- "IPv6 Settings" [p.106](#)
- "Mail Notification" [p.106](#)
- "SMTP Server" [p.107](#)
- "Port Number" [p.107](#)
- "From" [p.107](#)
- "Address 1 Setting/Address 2 Setting/Address 3 Setting" [p.107](#)
- "SNMP" [p.107](#)

- "Trap IP Address 1/Trap IP Address 2" [p.107](#)
- "Community Name" [p.107](#)
- "PJLink Notification" [p.108](#)
- "Notified IP Address" [p.108](#)
- "Command Communication" [p.108](#)
- "Secure HTTP" [p.108](#)
- "Web Server Certificate" [p.108](#)
- "Web API Settings" [p.108](#)
- "Priority Gateway" [p.109](#)
- "PJLink" [p.109](#)
- "AMX Device Discovery" [p.109](#)
- "Crestron Connected" [p.109](#)
- "Art-Net" [p.109](#)
- "Message Broadcasting" [p.109](#)
- "Reset (Network menu)" [p.109](#)

Wireless Mode

☛ Network > Wireless Mode

You can configure your wireless LAN settings.

Set to **Wireless LAN On** to project images via a wireless LAN. If you do not want to connect via wireless LAN, set to **Off** to prevent unauthorized access by others.



To connect the projector to the computer using a wireless network system, install the optional wireless LAN module.

Net. Info. - Wireless LAN

☛ Network > Net. Info. - Wireless LAN

You can view wireless network status and details.

Net. Info. - Wired LAN

☛ Network > Net. Info. - Wired LAN

You can view wired network status and details.

Display the QR Code

☛ Network > Display the QR Code

You can view a QR code for connecting with iOS or Android devices using the Epson iProjection app.

Remote Camera Access

☛ Network > Remote Camera Access

You can display the image taken by the optional external camera using Epson Web Control.

Remote Camera Access

Set to **On** to enable the Remote Camera Access function.

Password

This is useful for accessing the projector over the Web. (No password is set by default.)

Enter a password up to 32 alphanumeric characters long. (Do not use * : spaces.)

Projector Name

☛ Network > Network Configuration > Basic > Projector Name

This is useful to identify the projector over the network.

Enter a name up to 16 alphanumeric characters long. (Do not use " * + , / : ; < = > ? [\] ` | spaces.)

PJLink Password

☛ Network > Network Configuration > Basic > PJLink Password

This is useful for projector control using the PJLink protocol.

Enter a password up to 32 alphanumeric characters long. (Do not use spaces and any symbols other than @.)

Remote Password

☛ Network > Network Configuration > Basic > Remote Password

This is useful for accessing the projector using the Web Remote. (User name is EPSONREMOTE; default password is the projector's serial number.)

Enter a password up to 32 alphanumeric characters long. (Do not use * : spaces.)



Setting is only displayed when **Content Playback** is set to **Off**.

Web Control Password

☛ Network > Network Configuration > Basic > Web Control Password

This is useful for accessing the projector over the Web. (User name is EPSONWEB; default password is the projector's serial number.)

Enter a password up to 32 alphanumeric characters long. (Do not use * : spaces.)

Moderator Password

☛ Network > Network Configuration > Basic > Moderator Password

This is useful for accessing the projector as a moderator using Epson iProjection. (No password is set by default.)

Enter a four-digit number password.

Projector Keyword

☛ **Network > Network Configuration > Basic > Projector Keyword**

You can turn on a security password to prevent access to the projector by anyone not in the room with it.

You must enter a displayed, randomized keyword from a computer using Epson iProjection to access the projector and share the current screen.

Display Keyword

☛ **Network > Network Configuration > Basic > Display Keyword**

You can select whether to display a projector keyword on the projected image when accessing the projector using Epson iProjection.



Available when **Projector Keyword** is set to **On**.

Display LAN Info.

☛ **Network > Network Configuration > Basic > Display LAN Info.**

You can select the display format for the projector's network information.

By simply reading the QR code with Epson iProjection, you can connect the mobile device to the projector through a network. The default value is **Text & QR Code**.

Connection Mode

☛ **Network > Network Configuration > Wireless LAN > Connection Mode**

You can select the type of wireless connection.

Quick

You can connect to multiple smartphones, tablets, or computers directly using wireless communication.

When you select this connection mode, the projector acts as an easy access point. (We recommend limiting the number of devices to six or less to maintain the projection performance.)

Advanced

You can connect to multiple smartphones, tablets, or computers over a wireless network access point. The connection is established in infrastructure mode.

Search Access Point

☛ **Network > Network Configuration > Wireless LAN > Search Access Point**

You can search for available wireless network access points in Advanced connection mode. Depending on the access point settings, they may not be displayed in the list.



- A blue mark appears for access points that have already been set.
- A lock icon appears for access points for which security has been set. If you select an access point that has not had security set, the **Wireless LAN** menu is displayed. If you select an access point for which security has been set, the **Security** menu is displayed. Select the type of security according to the security settings for the access point.

SSID

☛ **Network > Network Configuration > Wireless LAN > SSID**

You can set the SSID (network name) of the wireless LAN system the projector is connecting to.

Security

☛ **Network > Network Configuration > Wireless LAN > Security**

You can set up security for your projector to use on a wireless network.

Open

Security is not set.

WPA2-PSK

Communication is performed using WPA2 security. Uses AES method for encryption. When establishing a connection from a computer to the projector, enter the value set in the passphrase.

WPA3-PSK

Connects in WPA3 personal mode. Communication is performed using WPA3 security. Uses AES method for encryption. When establishing a connection from a computer to the projector, enter the value set in the passphrase.

WPA2/WPA3-PSK

Connects in WPA2/WPA3 personal mode. Encryption method is selected automatically according to the access point settings. Set a passphrase which is the same for the access point.

WPA3-EAP

Connects in WPA3 enterprise mode. Encryption method is selected automatically according to the access point settings.

WPA2/WPA3-EAP

Connects in WPA2/WPA3 enterprise mode. Encryption method is selected automatically according to the access point settings.



- WPA2-PSK is available only for Quick connection mode.
- WPA3-PSK, WPA2/WPA3-PSK, WPA3-EAP, and WPA2/WPA3-EAP are available only for Advanced connection mode.
- When the **Mail Notification** is set to **Off**, you cannot set security.
- WPA is an encryption standard that improves the security for wireless networks. The projector supports TKIP and AES encryption methods. WPA also includes user authentication functions. WPA authentication provides two methods: using an authentication server, or authenticating between a computer and an access point without using a server. This projector supports the latter method, without a server.
- When setting security, follow the instructions from the administrator of the network system you want to connect to.

Passphrase

☛ **Network > Network Configuration > Wireless LAN > Passphrase**

For **WPA2-PSK**, **WPA3-PSK**, and **WPA2/WPA3-PSK** security, enter the pre-shared passphrase used on the network. You can enter various passphrases from 8 to 63 alphanumeric characters long.

When the passphrase is entered and the [Enter] button is pressed, the value is set and displayed as an asterisk (*).

We recommend changing the passphrase periodically for security. If the network settings are initialized, it returns to the initial passphrase.



- You can enter up to 32 characters in the projector's menu. To enter more than 32 characters, use your Web browser.
- When **Connection Mode** is set to **Quick**, the initial passphrase is set.

EAP Method

☛ **Network > Network Configuration > Wireless LAN > EAP Method**

You can set the EAP settings for **WPA3-EAP** and **WPA2/WPA3-EAP** security.

EAP Type

Select the protocol for authentication.

PEAP

Authentication protocol widely used in Windows Server.

PEAP-TLS

Authentication protocol used in Windows Server. Select this when using a client certificate.

EAP-TLS

Authentication protocol widely used to use a client certificate.

EAP-FAST

Select this when these authentication protocols are used.

User name

Enter a user name for the network up to 64 alphanumeric characters long. To include a domain name, add it before the backslash and the user name (domain\username).

When importing a client certificate, the name the certificate was issued to is automatically set.

Password

Enter a password for authentication up to 64 alphanumeric characters long. After you enter the password and select **Finish**, the password is displayed as an asterisk (*).

Client Certificate

Import the client certificate.

Verify Server Certificate

You can verify the server certificate when a CA certificate has been set.

CA certificate

Imports the CA certificate.

RADIUS Server Name

Enter the server name to verify up to 32 alphanumeric characters long.



- You can enter up to 32 alphanumeric characters long in the projector menu. To enter more than 32 characters, use your Web browser.
- **Password** is only displayed when **EAP Type** is set to **PEAP** or **EAP-FAST**.
- **Client Certificate** is only displayed when **EAP Type** is set to **PEAP-TLS** or **EAP-TLS**.

Channel

☛ **Network > Network Configuration > Wireless LAN > Channel**

Set the frequency band (channel) using in Quick connection mode.

If interference from other signals occurs, use a different channel.

IP Settings

☛ **Network > Network Configuration > Wireless LAN > IP Settings**

☛ **Network > Network Configuration > Wired LAN > IP Settings**

Set **DHCP** to **On** if your network assigns addresses automatically.

Set to **Off** to manually enter the network's **IP Address**, **Subnet Mask**, and **Gateway Address** using 0 to 255 for each address field.

Do not use these addresses:

- for the IP Address: 0.0.0.0, 127.x.x.x, 192.0.2.x, or 224.0.0.0 through 255.255.255.255
- for the Subnet Mask: 255.255.255.255 or 0.0.0.0 through 254.255.255.255
- for the Gateway Address: 0.0.0.0, 127.x.x.x, or 224.0.0.0 through 255.255.255.255

(where x is a number from 0 to 255)

SSID Display

☛ Network > Network Configuration > Wireless LAN > SSID Display

You can select whether to display the SSID on the network standby screen and Home screen.

IP Address Display

☛ Network > Network Configuration > Wireless LAN > IP Address Display

You can select whether to display the IP address on the network standby screen and Home screen.

IPv6 Settings

☛ Network > Network Configuration > Wireless LAN > IPv6 Settings

☛ Network > Network Configuration > Wired LAN > IPv6 Settings

You can select IPv6 settings when you connect the projector to the network using IPv6.

IPv6

Set to **On** to connect the projector to the network using IPv6.

One local link address is always set while using IPv6. This is composed of the interface ID created from fe80:: and the projector's MAC address.

IPv6 is supported to monitor and control the projector over a network using Epson Web Control and PjLink.

Auto Configuration

Set to **On** to assign addresses automatically according to the Router Advertisement.

The address is composed as shown below.

Stateless Address (0 to 6)

Created automatically by combining the prefix acquired from the RA (Router Advertisement) and the interface ID created from the projector's MAC address.

Stateful Address (0 to 1)

Created automatically from the DHCP server using DHCPv6.

Use Temporary Address

Set to **On** if you want to use a temporary IPv6 address.



You can set the IPv6 address manually in the **Advanced** menu in Epson Web Control.

Mail Notification

☛ Network > Network Configuration > Notifications > Mail Notification

Set to **On** to send an email to the preset addresses when a problem or warning occurs with a projector.

» Related Links

- "Network Projector E-mail Alert Messages" [p.106](#)

Network Projector E-mail Alert Messages

When a problem occurs with a projector on the network, and you selected to receive e-mail alerts, you receive an e-mail containing the following information:

- The email address set in **From** as the mail sender
- **Epson Projector** in the subject line
- The name of the projector experiencing a problem
- The IP address of the affected projector
- Detailed information about the problem

SMTP Server

☛ Network > Network Configuration > Notifications > SMTP Server

Enter the IP address for the projector's SMTP server using 0 to 255 for each address field.

Do not use these addresses: 127.x.x.x, 192.0.2.x or 224.0.0.0 through 255.255.255.255 (where x is a number from 0 to 255).

Port Number

☛ Network > Network Configuration > Notifications > Port Number

Enter a number for the SMTP server Port Number from 1 to 65535 (default is 25).

From

☛ Network > Network Configuration > Notifications > From

Enter the e-mail address of the sender up to 64 alphanumeric characters long. (Do not use " () , : ; < > [\] spaces.)



You can enter up to 32 alphanumeric characters long in the projector menu. To enter more than 32 characters, use your Web browser.

Address 1 Setting/Address 2 Setting/Address 3 Setting

☛ Network > Network Configuration > Notifications > Address 1 Setting

☛ Network > Network Configuration > Notifications > Address 2 Setting

☛ Network > Network Configuration > Notifications > Address 3 Setting

Enter the e-mail address to receive notifications up to 64 alphanumeric characters long. (Do not use " () , : ; < > [\] spaces.) And select the alerts you want to receive.



You can enter up to 32 alphanumeric characters long in the projector menu. To enter more than 32 characters, use your Web browser.

SNMP

☛ Network > Network Configuration > Notifications > SNMP

Set to **On** to monitor the projector using SNMP. To monitor the projector, you need to install the SNMP manager program on your computer. SNMP should be managed by a network administrator.

Trap IP Address 1/Trap IP Address 2

☛ Network > Network Configuration > Notifications > Trap IP Address 1

☛ Network > Network Configuration > Notifications > Trap IP Address 2

Enter up to two IP addresses to receive SNMP notifications, using 0 to 255 for each address field.

Do not use these addresses: 127.x.x.x or 224.0.0.0 through 255.255.255.255 (where x is a number from 0 to 255).

Community Name

☛ Network > Network Configuration > Notifications > Community Name

Enter the SNMP community name up to 32 alphanumeric characters long. (Do not use spaces and any symbols other than @.)

PJLink Notification

☛ **Network > Network Configuration > Notifications > PJLink Notification**

Set to **On** to enable the PJLink notification function when the PJLink setting is enabled.

Notified IP Address

☛ **Network > Network Configuration > Notifications > Notified IP Address**

Enter the IP address to receive the projector's operating status when the PJLink notification function is enabled. Enter the addresses using 0 to 255 for each address field.

Do not use these addresses: 127.x.x.x or 224.0.0.0 through 255.255.255.255 (where x is a number from 0 to 255).

Command Communication

☛ **Network > Network Configuration > Others > Command Communication**

You can select the authentication method for command communication.

Protected

Select when performing a digest authentication using **Web Control Password**. You need to install the latest version of the Epson Projector Management software.

Compatible

Select when performing plain text authentication using the Monitor Password (up to 16 alphanumeric characters long).



Select **Compatible** when monitoring projectors with a switcher and a system controller or using Epson Projector Management ver.5.30 or earlier.

Secure HTTP

☛ **Network > Network Configuration > Others > Secure HTTP**

To strengthen security, communication between the projector and computer in Web control is encrypted. When setting security with Web control, it is recommended to set this to **On**.

Web Server Certificate

☛ **Network > Network Configuration > Others > Web Server Certificate**

Imports the Web server certificate for secure HTTP.

Web API Settings

☛ **Network > Network Configuration > Others > Web API Settings**

You can select the Web API settings when using Web API communications.

Web API

Set to **On** to enable the Web API function.

Authentication

You can set the security for your projector to use during Web API communications.

Open

Security is not set.

Digest

Communication is performed using API authentication (Digest authentication).



See the *Web API Specifications for Projectors* for details.

Priority Gateway

☛ Network > Network Configuration > Others > Priority Gateway

You can set the priority gateway.

PJLink

☛ Network > Network Configuration > Others > PJLink

Set to **On** to monitor the projector using PJLink.

AMX Device Discovery

☛ Network > Network Configuration > Others > AMX Device Discovery

Set to **On** when you want to allow the projector to be detected by AMX Device Discovery.

Crestron Connected

☛ Network > Network Configuration > Others > Crestron Connected

Set to **On** only when monitoring or controlling the projector over the network using Crestron Connected.

Restart the projector to enable your changes.



Enabling Crestron Connected disables the Epson Message Broadcasting feature in the Epson Projector Management software.

Art-Net

☛ Network > Network Configuration > Others > Art-Net

Set to **On** when you want to control the projector using Art-Net.

Net

Enter a number for the projector's Net using 0 to 127 (default is 0).

Sub-Net

Enter a number for the projector's Sub-Net using 0 to 15 (default is 0).

Universe

Enter a number for the projector's Universe using 0 to 15 (default is 0).

Start Channel

Enter the start channel that handles Art-Net using 1 to 500 (default is 1).

Channel Information

You can view the channel information.

Message Broadcasting

☛ Network > Network Configuration > Others > Message Broadcasting

Set to **On** to receive the message delivered by Epson Projector Management. See the *Epson Projector Management Operation Guide* for details.



Setting is only displayed when **Crestron Connected** is set to **Off**.

Reset (Network menu)

☛ Network > Network Configuration > Reset

You can reset all adjustment values on the **Network** menu to their default settings.

You can display information about the projector and version by viewing the **Info** menu. However, you cannot change any settings in the menu.

► Related Links

- "Projector Info" [p.110](#)
- "Light Source Info" [p.111](#)
- "Version" [p.111](#)
- "Status Information" [p.111](#)
- "Voltage Warning Info" [p.112](#)
- "Temp Warning Info" [p.112](#)
- "Power On/Off History" [p.112](#)

Projector Info

☛ Info > Projector Info

You can view the projector's information.

Total Op. Time

Displays the number of hours the projector has been used in its operating life.

Operation Hours

Displays the number of hours the projector has been used since it was turned on.

The cumulative use time is displayed as "0H" for the first 10 hours. When exceeding 10 hours, it is displayed as "10H" and "11H" in 1 hour units.

Source

Displays the name of the port to which the current input source is connected.

Input Signal

Displays the input signal setting of the current input source.

Resolution

Displays the resolution of the current input source.

Refresh Rate

Displays the refresh rate of the current input source.

Sync Info

Displays information about video signals that may be needed by a service technician.

Color Format

Displays the color format of the current input source.

Status

Displays information about projector problems that may be needed by a service technician.

Serial Number

Displays the projector's serial number.

Lens Type

Displays the model number of the installed lens.

Event ID

Displays the Event ID number corresponding to a network problem; see the list of Event ID codes.

HDBaseT Signal Level

Displays the signal level of the HDBaseT transmitter; if the information is displayed in yellow, signal level is not enough.

► Related Links

- "Event ID Code List" [p.110](#)

Event ID Code List

If the **Event ID** option on the **Projector Info** menu displays a code number, check this list of Event ID codes for the solution to the projector problem associated with the code.

If you cannot resolve the problem, contact your network administrator or Epson for technical support.

Event ID code	Cause and solution
0432 0435	The network software did not start. Turn the projector off and then on again.
0433	Cannot display the transferred images. Restart the network software.

Event ID code	Cause and solution
0434 0481 0482 0485	Unstable network communication. Check the network communication status, wait a few moments, and try connecting to the network again.
0483 04FE	The network software quit unexpectedly. Check the network communication status, then turn the projector off and then on again.
0484	Communication with computer was disconnected. Restart the network software.
0479 04FF	A projector system error has occurred. Turn the projector off and then on again.
0891	Cannot find an access point with the same SSID. Set your computer, access point, and projector to the same SSID.
0892	The WPA/WPA2/WPA3 authentication type does not match. Make sure the wireless network security settings are correct.
0893	The TKIP/AES encryption type does not match. Make sure the wireless network security settings are correct.
0894	Communication with an unauthorized access point was disconnected. Contact your network administrator.
0895	Communication with a connected device was disconnected. Check your device connection status.
0898	Failed to acquire DHCP. Make sure the DHCP server is operating correctly. If you are not using DHCP, set the DHCP setting to Off in the projector's Network menu.
0899	Other communication errors.
089A	The EAP authentication type does not match the network. Check the wireless LAN security settings and make sure that the security certificate is installed correctly.
089B	EAP server authentication failed. Check the wireless LAN security settings and make sure that the security certificate is installed correctly.

Event ID code	Cause and solution
089C	EAP client authentication failed. Check the wireless LAN security settings and make sure that the security certificate is installed correctly.
089D	Key exchange failed. Check the wireless LAN security settings and make sure that the security certificate is installed correctly.
0920	The internal battery that saves the projector's date and time settings is running low. Contact Epson for help.

Light Source Info

Info > Light Source Info

You can view the projector's light source information.

Light Source Hours

Displays the number of operating hours for each of the projector's **Light Source Mode** settings.

Estimated Remains

If the **Constant Brightness** setting is enabled, displays the remaining number of hours the projector can maintain constant brightness.

Settings > Brightness Settings > Constant Brightness

Version

Info > Version

You can view the projector's firmware information.

Status Information

Info > Status Information

You can view the projector's basic status information.

Each category contains the following information.

Status Information

The projector's operating status.

Source

Input signal information.

Signal Information

Input digital signal information.

Network Wired

Wired LAN settings.

Network Wireless

Wireless LAN settings.

Maintenance

Operating time for the projector and light source.

Version

The projector's firmware version

» Related Links

- "Projector Status Display Messages" [p.153](#)

When you select **Detail** when a Warning or Error is displayed, you can check detailed logs for before and after the error was detected.

Power On/Off History

☛ **Info > Power On/Off History**

You can view the power on/off logs.

Voltage Warning Info

☛ **Info > Voltage Warning Info**

You can view various voltage warnings.

When you select **Detail** when a Warning or Error is displayed, you can check detailed logs for before and after the error was detected.

Temp Warning Info

☛ **Info > Temp Warning Info**

You can view various high temperature warnings.

Settings on the **Reset** menu let you reset certain projector settings to their default values.

► **Related Links**

- "Reset All Memories" [p.113](#)
- "Refresh Mode" [p.113](#)
- "Light Source Calibration" [p.113](#)
- "NFC Settings" [p.114](#)
- "Reset All Config" [p.114](#)
- "Reset All (Factory Default)" [p.114](#)

Reset All Memories

☛ **Reset > Reset All Memories**

You can delete all memories saved in **Memory**, **Lens Position**, and **Geometry Correction**.

Refresh Mode

☛ **Reset > Refresh Mode**

The refresh mode process clears any projected afterimage and turns off the projector after a specified period of time.

Timer

Set a time period during which the projector displays the refresh image.

Messages

Set to **On** to display a message informing you that the projector is in refresh mode.

Start

Starts the refresh mode process to clear any projected afterimage and turn off the projector after a specified period of time. Press any button on the remote control to cancel this process.

Light Source Calibration

☛ **Reset > Light Source Calibration**

The light source calibration process optimizes the color balance of the currently projected image.

Run Now

Starts light source calibration to optimize the color balance of the currently projected image. You may not be able to start calibration if the projector's environmental temperature is out of range. (Wait 30 minutes after turning on the projector before starting calibration for the best results.)

Light Source Calibration does not start in the following cases.

- If the projector is not used continuously for more than 20 minutes.
- If the surrounding temperature gets too high, and the brightness has been automatically dimmed.
- If you use the following functions and the brightness of the light source declines to a specific level or lower.
 - Dynamic Contrast
 - Lights-Out Control
 - A/V Mute
- Within 10 minutes of turning on the projector.
- If **Brightness Settings** is set to 30% or less.

Run Periodically

Set to **On** to perform light source calibration periodically every 100 hours of usage.

When set to **Off** to maintain the projected image that has been adjusted using Multi-Projection, perform calibration using **Run Now** or set a **Light Source Calibration** event to perform it periodically on the **Schedule Settings** screen.

Schedule Settings

Displays the **Schedule Settings** screen. Set a **Light Source Calibration** event to run periodically.

Last Run

Displays the date and time of the last light source calibration.

NFC Settings

☛ Reset > NFC Settings

You can prevent scanning to the projector's settings.

NFC Write Protection

Prevents anyone from scanning the projector's settings.

NFC Write Password

Set a password for scanning the projector's settings up to 32 alphanumeric characters long.



If you do not set an **NFC Write Password**, **NFC Write Protection** is enabled automatically when you turn on the projector. If you want to scan the projector's information using the NFC tag on the projector, set the **NFC Write Password** setting to **Off**.

Reset All Config

☛ Reset > Reset All Config

You can reset most of the projector settings to their default values.

You cannot reset the following settings:

- Memory
- Startup Screen *
- Panel Alignment
- Color Uniformity
- User's Logo *
- Date & Time
- Color Matching
- Language
- Network menu items
- NFC Settings

* Only when you set the **User's Logo Protection** setting to **On** in the **Password Protection** setting menu.

Reset All (Factory Default)

☛ Reset > Reset All (Factory Default)

You can reset the setting values to the values you set or to their factory default values.

Reset All (User Default)

You can apply the values you set in the **User Default Setting** menu.

Reset All (Factory Default)

You can reset all of the projector settings to their default factory values.

You cannot reset the following settings:

- Light Source Info
- Operation Hours
- Password Protection
- Password
- Schedule Settings *

* Only when you set **Schedule Protection** to **On** from the **Password Protection** screen.

User Default Setting

You can define the default value used when performing the **Reset All (User Default)** functions.

You can set the values for the following settings:

- Color Mode
- Light Source Mode
- Brightness Level
- Constant Brightness
- Messages
- Standby Confirmation
- A/V Mute Timer

- Release A/V Mute
- Beep
- A/V Settings
- Standby Mode
- Sleep Mode
- Language
- Wireless Mode
- DHCP (in the Wired LAN menu)
- Command Communication

Password Setting

You can set a password when resetting values to the user default setting values or to their factory default values. The default password is set to "0000". Change this to your own password.

Adjusting Projector Features

Follow the instructions in these sections to use your projector's adjustment features.

► **Related Links**

- "Multi-Projection Features" [p.117](#)
- "External Camera Usage" [p.122](#)

You can combine the projected images from multiple projectors to create one bright image or a large seamless image.

By using the auto adjustment function that uses the optional external camera and the Epson Project Professional Tool software you can perform virtually adjustment-free operation.



You can download the Epson Projector Professional Tool software and its manual from the following website.
epson.sn

» Related Links

- "Procedure Overview" [p.117](#)
- "Preparation" [p.117](#)
- "Image Composition" [p.119](#)
- "Adjusting Colors" [p.120](#)

Procedure Overview

This section explains the recommended procedure for using the optional external camera and the Epson Projector Professional Tool software.

Preparation

- Initializing projectors
- Assigning a master projector
- Calibrating projectors
- Installing projectors
- Performing rough image adjustments
- Connecting projectors to a network

Image Composition

- Tiling
- Stacking

Adjusting colors

Preparation

This section explains how to perform basic settings before installing the projector and preparing in advance for easier operations later.

You can setup up to 15 projectors to project one large image by compositing several images (tiling) and up to 6 projectors to project a bright image by overlaying images (stacking).

» Related Links

- "Initializing Projectors" [p.117](#)
- "Assigning a Master Projector" [p.118](#)
- "Calibrating Projectors" [p.118](#)
- "Installing Projectors" [p.118](#)
- "Performing Rough Image Adjustments" [p.118](#)
- "Connecting Projectors to a Network" [p.119](#)

Initializing Projectors

You need to correct the difference in settings for each projector.

Do the following operations for all projectors:

- Reset the projector settings to their default values.
 - ☛ **Reset > Reset All Config**
- Reset the values on the **Color Uniformity** menu to their default settings.
 - ☛ **Extended > Display > Color Uniformity > Reset**
- Reset the values on the **Panel Alignment** menu to their default settings.
 - ☛ **Extended > Display > Panel Alignment > Reset**
- Set the **Adjustment Level** setting to **All** in the **Color Matching** menu, and select **0** for **Red**, **Green**, and **Blue**.
 - ☛ **Extended > Multi-Projection > Screen Matching > Color Matching**



We recommend you set the **Sleep Mode** setting to **Off** in the projector's **Extended** menu after all initialization is complete.

» Related Links

- "Sleep Mode" [p.92](#)

Assigning a Master Projector

Select one projector to be the basis for adjustment.

Display test patterns from all projectors and select the one that has less color unevenness as the master projector.



- You can display the test pattern by pressing the **Test Pattern** button on the control panel or remote control.
- We recommend displaying the following test patterns: **Gray Bars V**, **Gray Bars H**, and **White**
- When using the remote control, we recommend assigning the same ID for the master projector and the remote control to limit the control target.

» Related Links

- "Projector ID" [p.96](#)

Calibrating Projectors

Adjust changes that occur over time due to repeated use of projectors.

Perform the following operations for all projectors:

- Perform light source calibration.
 - ☛ **Reset > Light Source Calibration**
- Perform color calibration.
 - ☛ **Extended > Color Calibration**

To extend the adjustment range, set the **Color Mode** setting to **Multi-Projection** in the projector's **Image** menu.



- If you do not install the optional external camera or you were unsuccessful performing color calibration, perform **Color Uniformity**.
- If you set **Run Periodically** to **On** in the **Light Source Calibration** menu, the color adjusted in multi-projection may be changed due to auto calibration.
- You can also change the projector's **Color Mode** using the [Color Mode] button on the remote control.

Installing Projectors

Install all projectors in an appropriate location.

When you install the master projector in the center, you can easily calibrate colors because any unevenness at the center of the projected area is reduced.

Performing Rough Image Adjustments

Perform the following operations for all projectors to adjust the position and the shape for rectangular projected images.

Displaying the test pattern makes it easier to adjust the projection position and the shape.

- For projection position, adjust the location, the angle, and the lens shift.
- For projection size, adjust the location and the zoom.
- For image focus, adjust the focus.



- The projected images are not stable right after turning on the projector. We recommend adjusting the projector at least 20 minutes after you start projecting.
- We recommend displaying the following test patterns: **Gray Bars V**, **Gray Bars H**, and **White**
- When adjusting the image height with vertical lens shift, adjust it by moving the image from the bottom to the top. If you finish adjusting with the projected image at the bottom, the projected image may be in a low position.
- It is not recommended that you perform geometry correction for the following reasons:
 - Image quality may decline.
 - If the correction value is too large, image calibration may be difficult.

» Related Links

- "Lens Shift" [p.56](#)
- "Zoom" [p.56](#)
- "Focus" [p.58](#)

Connecting Projectors to a Network

Connect all projectors to the network hub with LAN cables.

When a connection is established, check that all projectors have been assigned their own IP address assigned.

» Related Links

- "Wired Network Connection" [p.37](#)

Image Composition

You can create a bright composite image and a large image from multiple projectors.

Before composing the images, select the following settings in the Epson Projector Professional Tool software.

- Create a group of projectors in the **Layout/Monitoring** tab.
- Specify each projector's position using **Tiling and Stacking Settings** on the **Edit Group** screen.



If Epson Projector Professional Tool software is not available, create a group in the projector's menu.

☛ **Extended > Multi-Projection > Projector Grouping**

» Related Links

- "Tiling" [p.119](#)
- "Stacking" [p.120](#)
- "Projector Grouping" [p.96](#)

Tiling

You can project one large image from up to 15 projectors.

Start the **Geometry Correction Assist - Tiling Function** wizard in the Epson Projector Professional Tool software.

☛ **Setting > Camera Assist > Geometry Correction Assist > Tiling > Start**

When the wizard has finished, perform the following operations as necessary:

- **Screen Matching** to correct the tint and brightness of each projected image.
- **Point Correction** to adjust the gaps in the positions of the projected image.
- **Scale** to crop and/or scale portions of the image.



- The required time for configuring tiling automatically varies depending on the layout and number of projectors. It takes up to approximately 8 minutes.
- The required time for screen matching varies depending on the layout and number of projectors. It takes up to approximately 18 minutes.
- If you have not installed the optional external camera or the Epson Projector Professional Tool software is not available, select the following settings from the **Multi-Projection** setting in the projector's **Extended** menu:
 - Tiling
 - Edge Blending
 - Screen Matching
 - Brightness Settings
 - Color Matching
 - Black Level
- You can setup up to 9 projectors when using the projector's menu.

» Related Links

- "Point Correction" [p.58](#)
- "Brightness Settings" [p.60](#)
- "Tiling" [p.96](#)
- "Scale" [p.78](#)
- "Edge Blending" [p.96](#)
- "Screen Matching" [p.97](#)
- "Color Matching" [p.98](#)
- "Black Level" [p.97](#)

Stacking

You can create one bright image by overlaying images from up to 6 projectors.

Start the **Geometry Correction Assist - Stacking Function** wizard in the Epson Projector Professional Tool software.

☛ **Setting** > **Camera Assist** > **Geometry Correction Assist** > **Stacking** > **Start**

When the wizard has finished, if there are any gaps in the pixels of the projected images, adjust the **Point Correction** setting manually.



- The required time to automatically configure stacking varies depending on the layout and number of projectors. It takes up to approximately 9 minutes.
- If the Epson Projector Professional Tool software is not available, start automatic adjustment on the master projector using the projector's menu. You can setup up to 2 projectors when using the projector's menu.
 - ☛ **Extended** > **Multi-Projection** > **Simple Stacking** > **Start Auto Adjustment**
- If you have not installed the optional external camera, adjust the following settings manually:
 - Focus
 - Zoom
 - Lens Shift
 - Geometry Correction

» Related Links

- "Point Correction" [p.58](#)
- "Lens Shift" [p.56](#)
- "Zoom" [p.56](#)
- "Focus" [p.58](#)
- "Conditions for Simple Stacking" [p.99](#)
- "Simple Stacking" [p.98](#)
- "Geometry Correction" [p.79](#)

Adjusting Colors

Display the test patterns from all projectors to check each color tone.

If you need adjust the color tone, perform the following operations:

- Adjust the Hue, Saturation, and Brightness settings for individual image colors.

☛ **Image** > **Advanced** > **RGBCMY**

- Adjust the overall tint of the image.

☛ **Image > White Balance**



We recommend displaying the following test patterns:
Gray Bars V, Gray Bars H, and White

You can use extended functions such as the Camera Assist function and Remote Camera Access with the optional external camera.

The extended functions reduce the time and effort needed to adjust the image.

When using the optional external camera, the following operations that are normally required for general camera solutions become unnecessary:

- Preparation such as securing installation location and adjusting the angle of view.

As the optional external camera is installed on the projector or the lens, a tripod and installation space is unnecessary. There is also no need to adjust the focus, angle, and exposure.

- Activation

Epson Projector Professional Tool software and Epson Web Control allow you to use the extended functions.



You can download the Epson Projector Professional Tool software and manual from the following website.

epson.sn

» Related Links

- "Camera Assist Function" [p.122](#)
- "Multi-Projection Features" [p.117](#)
- "Web Control Options" [p.129](#)

Camera Assist Function

You can automatically adjust the image using the optional external camera.

The following camera assist functions are available with your projector:

- **Geometry Correction Assist - Tiling Function** (with the Epson Projector Professional Tool software)

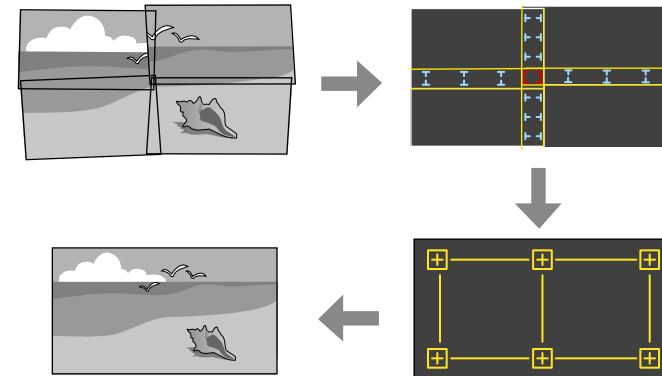

You can easily and quickly create a single seamless image from multiple projectors when projecting on a flat screen.

By selecting the appropriate **Edge Blending** setting and adjusting the approximate size and position of your image, the projectors automatically combine these images and correct the image shape.

- **Geometry Correction Assist - Stacking Function** (with the Epson Projector Professional Tool software)/**Simple Stacking**

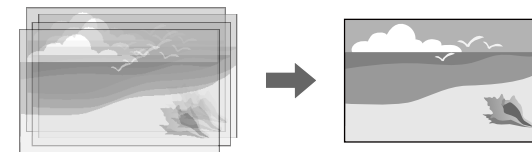

You can easily and quickly create a bright image by overlapping the images of multiple projectors.

By adjusting the approximate size and position of your image, the projectors automatically overlap these images to create one image.

If you do not have access to the Epson Projector Professional Tool software, you can easily and quickly create a bright image by using the **Simple Stacking** menu in the projector's menu.

☛ **Extended > Multi-Projection > Simple Stacking**

- **Screen Matching**

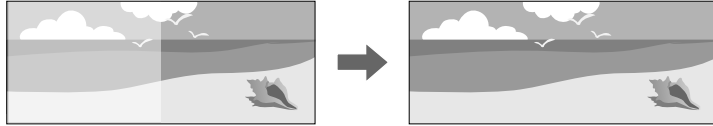

You can correct differences in the tint and brightness between projectors to optimize the display quality of the combined image.

- **Color Calibration**

When the color tone of the screen declines over time, you can automatically adjust the color tone of the entire screen based on the default color settings.

- » **Related Links**

- "Simple Stacking" [p.98](#)
- "Color Matching" [p.98](#)
- "Color Calibration" [p.95](#)

Monitoring and Controlling the Projector

Follow the instructions in these sections to monitor and control the projector over a network.

► **Related Links**

- "Projector Monitoring and Control Options" [p.125](#)
- "Accessing a Networked Projector Using a Web Browser" [p.128](#)

You can monitor and control the projector over a network in various way.

► Related Links

- "Epson Projector Management" [p.125](#)
- "Epson Web Control" [p.125](#)
- "SNMP" [p.125](#)
- "ESC/VP21 Commands" [p.125](#)
- "ESC/VP.net Commands" [p.126](#)
- "PJLink" [p.126](#)
- "Art-Net" [p.126](#)
- "Crestron Connected Support" [p.126](#)
- "Web API" [p.127](#)

Epson Projector Management

Epson Projector Management software (Windows only) lets you monitor and control your projector through the network. See the *Epson Projector Management Operation Guide* for instructions.

You can download Epson Projector Management from the following Web site.

epson.sn



The authentication method when registering projectors varies depending on the version of the Epson Projector Management software you are using. For the best results, we recommend that you use the latest version of the Epson Projector Management software.

Epson Web Control

Once you have connected your projector to your network, you can select projector settings and control projection using a compatible Web browser. This lets you access the projector remotely.

In Content Playback mode, you can also edit playlists.



- You can use the following Web browsers.
 - Internet Explorer 11 or later (Windows)
 - Microsoft Edge (Windows)
 - Safari (Mac, iOS)
 - Chrome (Android)
- While using the Web browser, do not connect using a proxy server. You cannot select all of the projector menu settings or control all projector functions using a Web browser.
- If you set **Standby Mode** to **Communication On**, you can use a Web browser to select settings and control projection even if the projector is in standby mode (when the power is off).
 - ☛ **Extended > Standby Mode**

► Related Links

- "Accessing a Networked Projector Using a Web Browser" [p.128](#)

SNMP

Network administrators can install SNMP (Simple Network Management Protocol) software on network computers so they can monitor projectors. If your network uses this software, you can set up the projector for SNMP monitoring.

☛ **Network > Network Configuration > Notifications > SNMP**



- This projector supports SNMP agent version 1 (SNMPv1).
- You cannot monitor projectors using SNMP in the Quick connection mode.

ESC/VP21 Commands

You can control the projector from an external device using ESC/VP21.

When the power ON command is transmitted to the projector, the power turns on and it enters warm-up mode. When the projector's power has turned on, a colon ":" (3Ah) is returned.

When a command is input, the projector executes the command and returns a ":", and then accepts the next command.

If the command being processed terminates abnormally, an error message is output and a ":" is returned.

You can check the available commands and cable layouts in the projector's *Specifications*.

ESC/VP.net Commands

You can monitor the projector using ESC/VP.net commands.

When the **Command Communication** setting is set to **Protected**, you can connect the projector with version 2.0 using **Web Control Password**.

When the **Command Communication** setting is set to **Compatible**, you can connect the projector with version 2.0 or 1.0. Use **Monitor Password** for version 1.0. You can set **Monitor Password** in Epson Web Control.

☛ **Network > Network Configuration > Others > Command Communication**

You can check the available commands and port number in the projector's *Specifications*.

PJLink

PJLink was established by the JBMIA (Japan Business Machine and Information System Industries Association) as a standard protocol for controlling network-compatible projector's as part of their efforts to standardize projector control protocols.

The projector complies with the PJLink Class2 standard established by the JBMIA.

The port number used for the PJLink search function is 4352 (UDP).

You need to make network settings before you can use PJLink.

☛ **Network > Network Configuration > Basic > PJLink Password**

☛ **Network > Network Configuration > Notifications > PJLink Notification**

☛ **Network > Network Configuration > Others > PJLink**

It complies with all commands except for the following commands defined by PJLink Class2, and agreement was confirmed by the PJLink standard adaptability verification.

Non-compatible commands:

Function		PJLink command
Mute settings	Image muting set	AVMT 11
	Audio muting set	AVMT 21

<http://pjlink.jbmia.or.jp/english/>

You can check the additional information on the PJLink support in the projector's *Specifications*.

Art-Net

Art-Net is an Ethernet communication protocol based on the TCP/IP protocol. You can control the projector by using a DMX controller or an application system.

You can check the channel definitions used to control the projector in the projector's *Specifications*.

Crestron Connected Support

If you are using the Crestron Connected network monitoring and control system, you can set up your projector for use on the system. Crestron Connected lets you control and monitor your projector using a Web browser.

You can access the Crestron Connected operation window from Epson Web Control. You need to enable Crestron Connected in the projector's **Network** menu before you can use Crestron Connected.

☛ **Network > Network Configuration > Others > Crestron Connected**



- You cannot use the Message Broadcasting feature in Epson Projector Management when you use Crestron Connected.
- If you set the **Standby Mode** setting to **Communication On**, you can control the projector even if the projector is in standby mode (when the power is off).
 - ☛ **Extended > Standby Mode**

For additional information on Crestron Connected, visit the Crestron Web site.

<https://www.crestron.com/products/line/crestron-connected>

To monitor devices in the system, you can use Crestron RoomView Express or Crestron Fusion provided by Crestron. You can communicate with the help desk and send emergency messages. See the following Web site for details.

<http://www.crestron.com/getroomview>

Web API

You can use Web API to operate the projector. See the *Web API Specifications for Projectors* for details.



- You can authenticate Web API communications using API authentication (Digest authentication).
- The user name for API authentication is **EPSONWEB**; use the password that is set for **Web Control Password**.

Once you have connected your projector to your network, you can select projector settings and control projection using a compatible Web browser. This lets you access the projector remotely.

- 1 Make sure the projector is turned on.
- 2 Make sure your computer or device is connected to the same network as the projector.
- 3 Start your Web browser on the computer or device.
- 4 Go to the **Epson Web Control** screen by entering the projector's IP address into the browser's address box. When entering an IPv6 address, wrap the address with [and].

You see the **Epson Web Control** screen.

- In normal mode

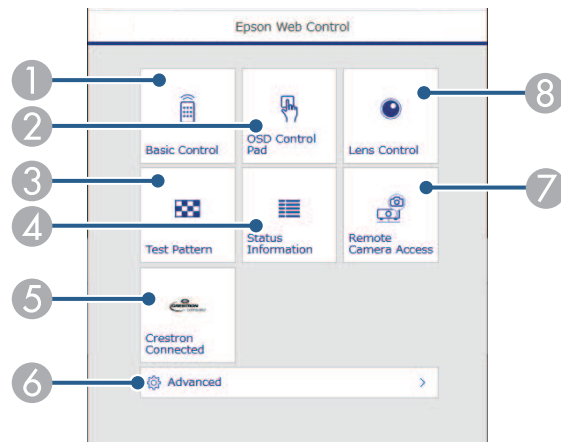

- 1 Controls the projector remotely.
- 2 Operates the projector's menu settings with your finger or mouse.
- 3 Displays a test pattern.
- 4 Displays the projector's status.

- 5 Opens the Crestron Connected operation window. Available only when you set the Crestron Connected system.
- 6 Opens detailed projector settings.
- 7 Takes an image capture of the displayed image from a remote location.
- 8 Operates the projector's lens.

- In Content Playback mode

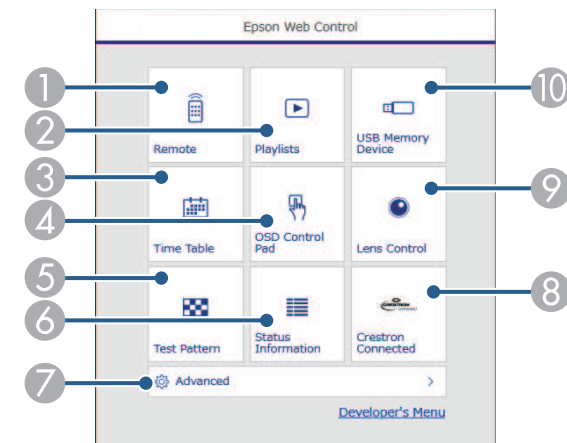

- 1 Controls the projector remotely.
- 2 Selects the playlist you want to play, and allows you to create or edit playlists.
- 3 Opens the **Time Table** screen.
- 4 Operates the projector's menu settings with your finger or mouse.
- 5 Displays a test pattern.
- 6 Displays the projector's status.
- 7 Opens detailed projector settings.
- 8 Opens the Crestron Connected operation window. Available only when you set the Crestron Connected system.
- 9 Operates the projector's lens.

- 10 Registers or deletes the data for a playlist on the USB flash drive.

5 Select the option corresponding to the projector function you want to control.

 You may need to log in to access some of the options on the **Epson Web Control** screen. If you see a log in window, enter your user name and password.

- When accessing the **Basic Control** option, the user name is **EPSONREMOTE** and the default password is the projector's serial number.
- When accessing other options, the user name is **EPSONWEB** and the default password is the projector's serial number.

You can change the password in the projector's **Network** menu.

- Network > Network Configuration > Basic > Remote Password**
- Network > Network Configuration > Basic > Web Control Password**

 If you see a log in window, enter your user name and password. (The user name is **EPSONREMOTE** and the default password is the projector's serial number.)

- You can change the password in the projector's **Network** menu.
- Network > Network Configuration > Basic > Remote Password**

» Related Links

- "Web Control Options" [p.129](#)

Web Control Options

Basic Control (only in normal mode)

Options on the **Basic Control** screen allow you to select the input source and control the projector.

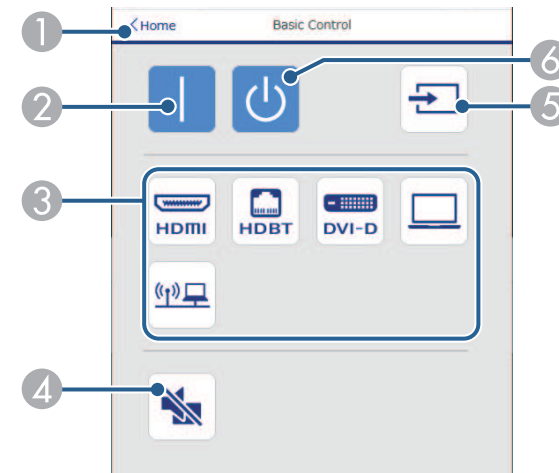

- 1 Returns to the **Epson Web Control** screen.
- 2 Turns the projector on.
- 3 Selects the input source. (The available sources vary depending on your projector model.)
- 4 Turns the video and audio on or off temporarily.
- 5 Detects the input signal automatically.
- 6 Turns the projector off.

OSD Control Pad

Options on the **OSD Control Pad** screen allow you to display the projector's setting menus and select them moving your finger or mouse on the pad.

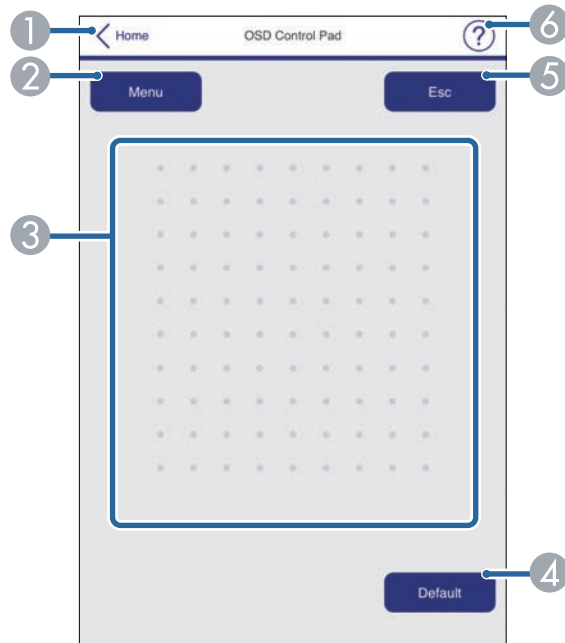

- 1 Returns to the **Epson Web Control** screen.
- 2 Displays the projector's setting menus.
- 3 Use your finger or mouse to navigate the menus.
- 4 Resets the selected setting to its default value.
- 5 Returns to the previous menu.
- 6 Displays help topics.

Lens Control

Options on the **Lens Control** screen allow you to operate the lens of the projector.

Focus/Distortion screen

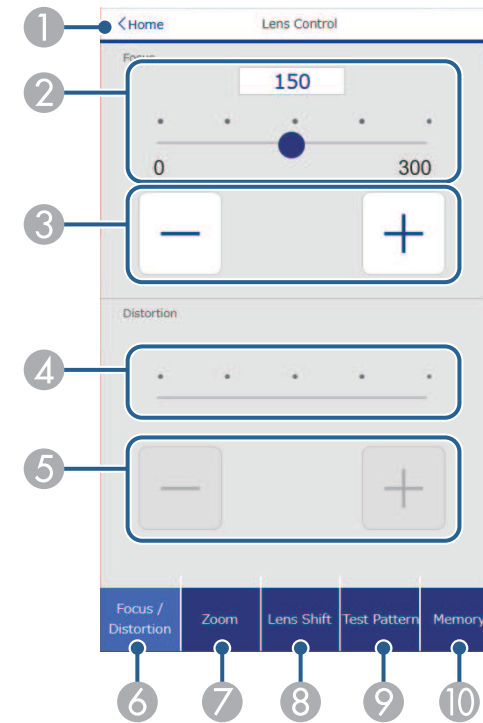

- 1 Returns to the **Epson Web Control** screen.
- 2 Focus adjustment slider.
- 3 Focus adjustment buttons.
- 4 Distortion adjustment slider.
- 5 Distortion adjustment buttons.
- 6 Displays the **Focus/Distortion** screen.
- 7 Displays the **Zoom** screen.
- 8 Displays the **Lens Shift** screen.
- 9 Displays the **Test Pattern** screen.

- ⑩ Displays the **Memory** screen.

Zoom screen

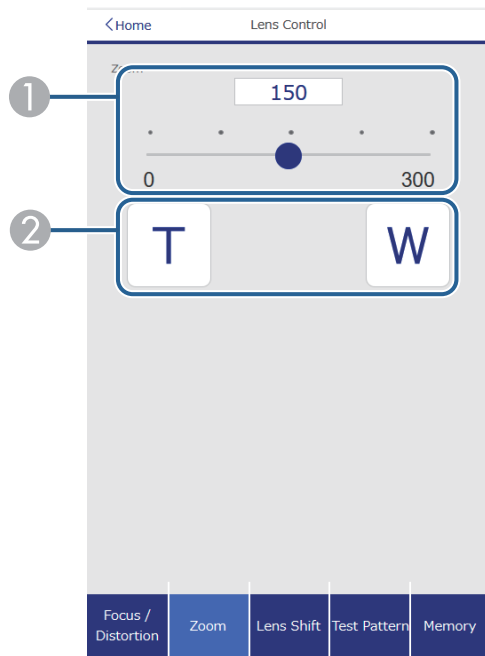

- ① Zoom adjustment slider.
- ② Zoom adjustment buttons.

Lens Shift screen

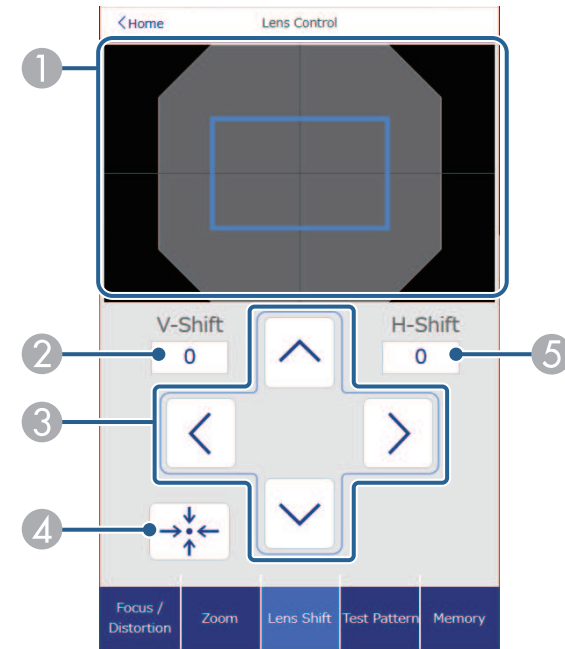

- ① The blue square displays the current image position and the red square displays the new image position.
- ② Displays the vertical image position; select to change the value.
- ③ Moves the image position up, down, left, or right.
- ④ Moves the lens to the home position.
- ⑤ Displays the horizontal image position; select to change the value.

Test Pattern screen

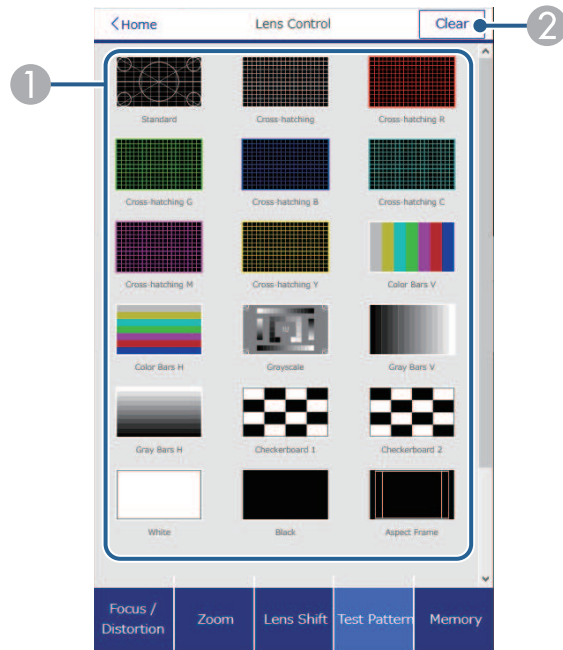

- ① Displays available test patterns; select to project a test pattern.
- ② Turns off test pattern display.

Memory screen

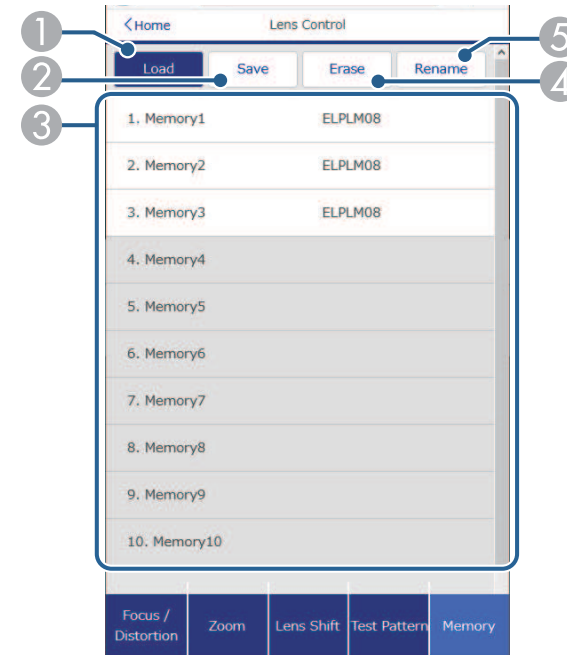

- ① Overwrites your current settings with saved settings.
- ② Saves your current settings to memory.
- ③ Displays a list of saved memories.
- ④ Erases a saved memory.
- ⑤ Renames a saved memory.

Status Information

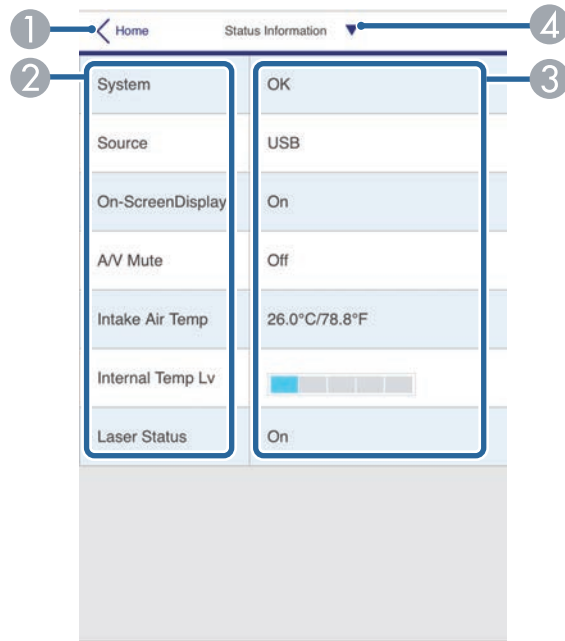

- ① Returns to the **Epson Web Control** screen.
- ② Displays a list of monitored settings.
- ③ Displays the setting status.
- ④ Select to view different status information.

Remote Camera Access (only in normal mode)

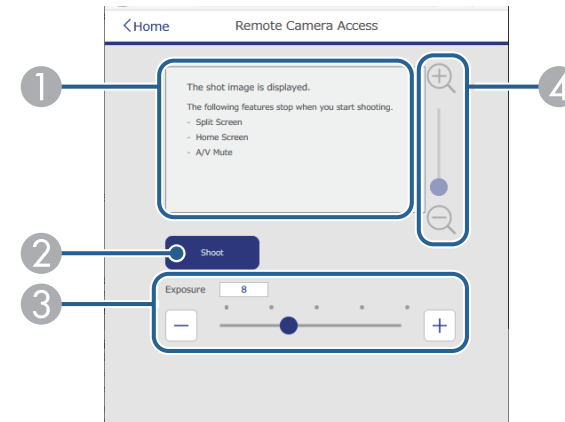

- ① Displays the image you captured using the **Shoot** button.
- ② Takes a picture of the projected image using the camera on the front of the projector.
- ③ Adjusts the image exposure.
- ④ Zooms in or out on the image you captured.

Advanced

The **Advanced** screen allow you to select the projector's settings.



If the default **Web Control Password** is set, a screen prompting to change the password appears before you can view the **Advanced** screen. Follow the on-screen instructions to change the password. It is strongly recommended to change password regularly to prevent an unauthorized access to your projector.

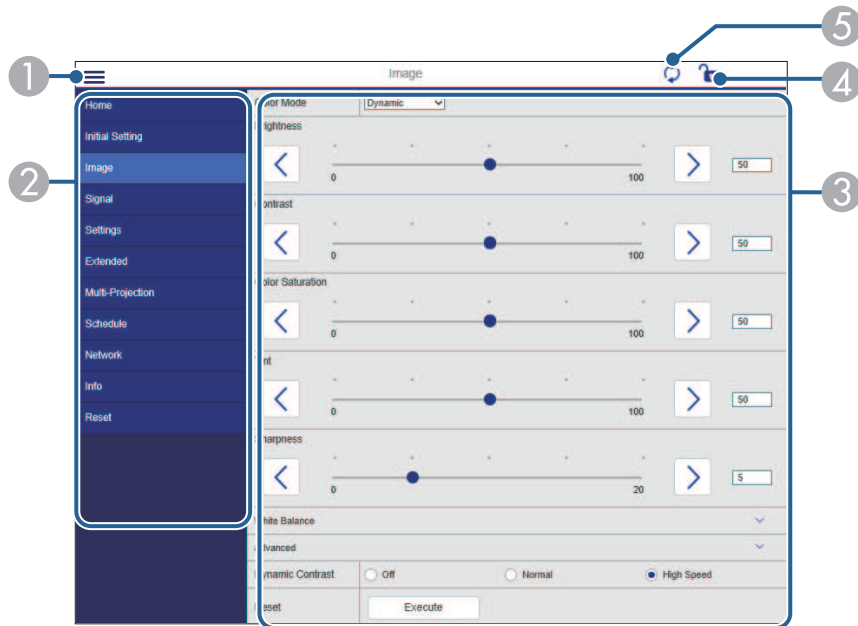

- ① Opens the menus.
- ② Displays the menu name you selected.
- ③ Specifies the projector settings. (The available settings vary depending on your projector model.)
- ④ Lock/unlock the projector settings.
- ⑤ Updates the projector settings.



You cannot change the following settings using Epson Web Control.

- Custom setting for Gamma
- EDID
- HDMI Link
- User Button
- Content Playback
- Simple Stacking
- Message Position
- User's Logo
- Lens Type
- Lens Calibration
- Language
- Wireless LAN Diagnosis
- Search Access Point
- Crestron Connected
- Event ID
- HDBaseT Signal Level
- Antenna Level



You can select the following settings only with Epson Web Control.

- Monitor Password (up to 16 alphanumeric characters) (only when Command Communication is set to Compatible)
- IPv6 Settings (manual)
- HTTP port (port number used for Web Control except for 80 [default], 843, 3620, 3621, 3625, 3629, 4352, 4649, 5357, 10000, 10001, 41794)

Remote (only in Content Playback mode)

Options on the **Remote** screen allow you to select the input source, control the projector, and start projecting playlists.

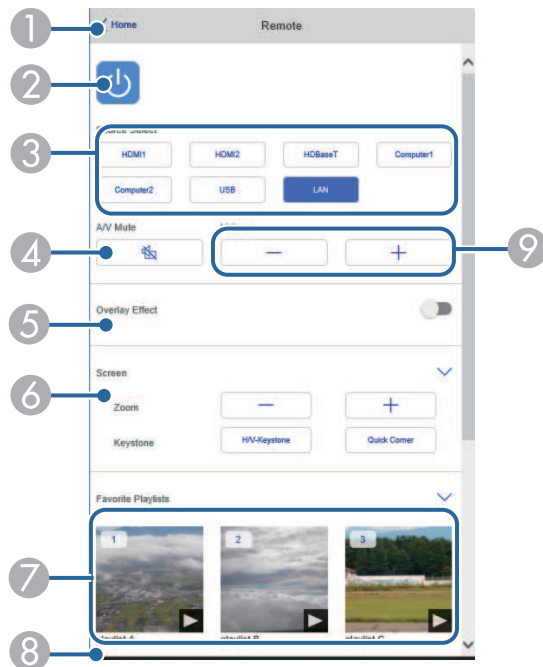

- 1 Returns to the **Epson Web Control** screen.
- 2 Turns the projector on or off.
- 3 Selects the input source. (The available sources vary depending on your projector model.)
- 4 Turns the video and audio on or off temporarily.
- 5 **Overlay Effect** option is displayed when the current source is anything other than USB.

Turns **Overlay Effect** on or off to add color and shape effects to a playlist.

When turning on, the **Effects** screen is displayed. You can add predefined color and shape effect filters to a playlist. You can also create a customized effect.

- 6 Specifies the screen settings.
- 7 Displays your favorite playlists. Select a playlist to start projecting.
- 8 Displays information for the playlist being projected.
The icons indicate the playlist settings.
 - : Overlay effects have been applied
 - : Repeat playback has been applied
 - : Length of the playlist
 Select the arrow at the bottom-right to display the following screen.
- 9 Adjusts the speaker volume.

Screen displayed while projecting playlist (only in Content Playback mode)

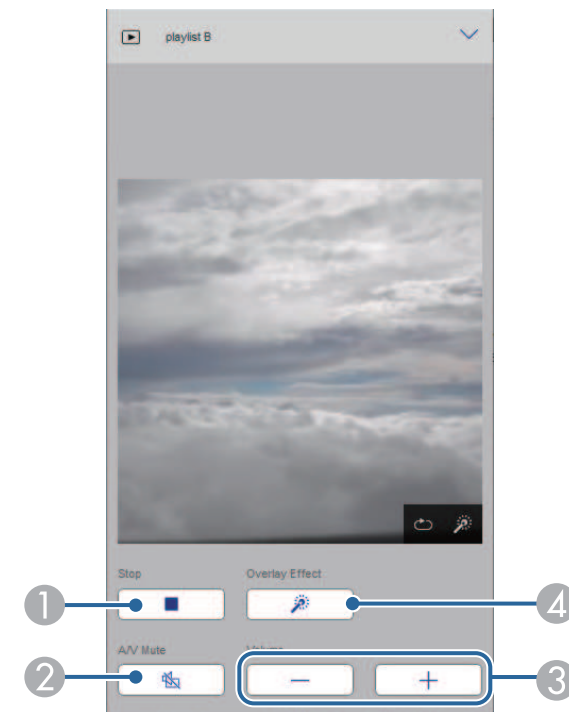

- 1 Stops projection.
- 2 Turns the video and audio on or off temporarily. However, the audio and video continue to run so you cannot resume projection at the point you activated this function.
- 3 Adjusts the speaker volume.
- 4 Opens the **Effects** screen. You can select preset effects or select individual brightness, color, and shape effect filters.

Playlist (only in Content Playback mode)

Options on the **Playlist** screen allow you to select the playlist you want to play from the list, and create or edit playlists.

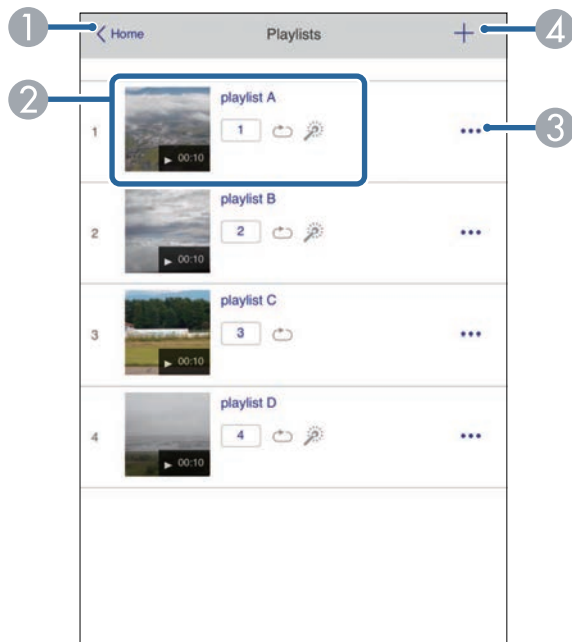

- 1 Returns to the **Epson Web Control** screen.

- 2 Starts projecting the playlist.
The icons indicate the playlist settings.
 - : Number assigned to your favorite playlists
 - : Repeat playback has been applied
 - : Overlay effects have been applied
- 3 Opens the menu that allows you to edit, copy, register to your favorites, or delete the playlist.
When you select **Edit** or **Duplicate**, the edit playlist screen is displayed.
- 4 Opens the create playlist screen where you can create a new playlist.

Create or edit playlist screen (only in Content Playback mode)



- 1 Edits the playlist name.

- ② Selects whether to enable repeat playback or not.
- ③ Registers the playlist as favorites.
When registering favorites, you can quickly start playback of the favorite playlist using the **Remote** screen or the remote control.
- ④ Displays the images or movies you have added to the playlist. The playlist plays the images or movies in order.
- ⑤ Adds images or movies to the playlist.
- ⑥ Deletes images or movies from the list.
- ⑦ Opens the **Switch Image** screen.
You can specify the time interval to switch to the next image file. You can also select a transition effect.
- ⑧ Opens the **Effects** screen.
You can add predefined color and shape effect filters to a playlist. You can also create a customized effect.
- ⑨ Previews the playlist.

USB Memory Device (only in Content Playback mode)

Options on the **USB Memory Device** screen allow you to upload data for a playlist to the USB flash drive or delete the data on the USB flash drive.



You can upload .avi, .jpeg (.jpg), .png, .bmp, or .gif files.

If you want to add the .mp4 and .mov files to the playlist, use the Epson Projector Content Manager software or the Epson Creative Projection app.

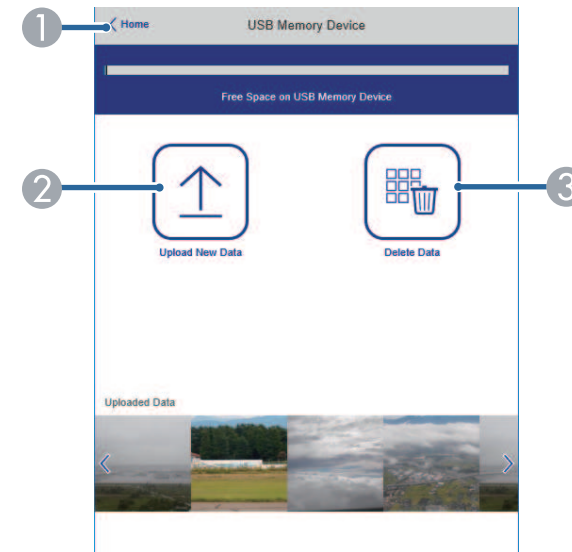

- ① Returns to the **Epson Web Control** screen.
- ② Copies images or movies you want to add to playlists to a USB flash drive.
- ③ Deletes images or movies on the USB flash drive.

Time Table (only in Content Playback mode)

Options on the **Time Table** screen allow you to enable or disable the specified time table features.

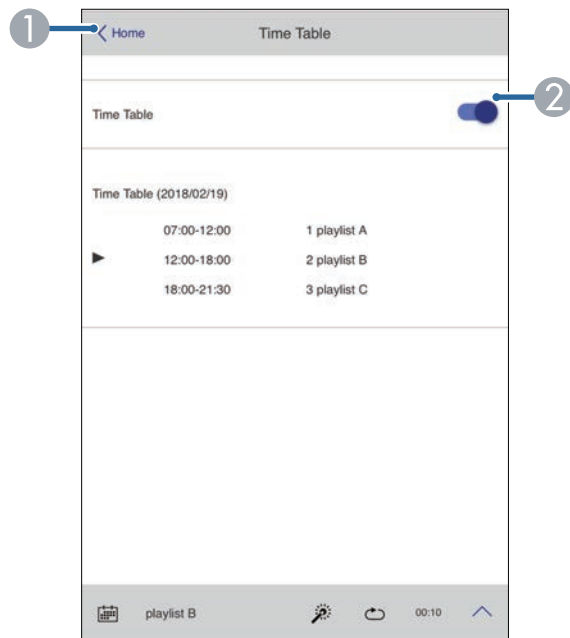

- ① Returns to the **Epson Web Control** screen.
- ② Turns the time table on or off.



You can specify when each playlist starts and finishes using the time table feature in the Epson Projector Content Manager software. For details, see the *Epson Projector Content Manager Operation Guide*.

Maintaining the Projector

Follow the instructions in these sections to maintain your projector.

► Related Links

- "Projector Maintenance" [p.140](#)
- "Cleaning the Lens" [p.141](#)
- "Cleaning the Projector Case" [p.142](#)
- "Air Filter and Vent Maintenance" [p.143](#)

You may need to clean the projector's lens periodically, and clean the air filter and air vents to prevent the projector from overheating due to blocked ventilation.

The only parts you should replace are the air filter, remote control batteries, and lens. If any other part needs replacing, contact Epson or an authorized Epson servicer.

Warning

Before cleaning any part of the projector, turn it off and unplug the power cord. Never open any cover on the projector, except as specifically explained in this manual. Dangerous electrical voltages in the projector can injure you severely.

Clean the projector's lens periodically, or whenever you notice dust or smudges on the surface.

- To remove dust or smudges, gently wipe the lens with lens-cleaning paper. If the lens is very dirty, use a vacuum cleaner or a air blower to remove any dust or smudges, and wipe the lens.
- To remove stubborn smudges, moisten a soft, lint-free cloth with lens cleaner and gently wipe the lens. Do not spray any liquid directly on the lens.

Warning

Do not use a lens cleaner that contains flammable gas. The high heat generated by the projector may cause a fire.

Attention

- Do not wipe the lens immediately after turning off the light source; otherwise, it could be damaged.
- Do not use glass cleaner or any harsh materials to clean the lens and do not subject the lens to any impacts; otherwise, it could be damaged. Do not use canned air, or the gases may leave a flammable residue.

Before cleaning the projector case, turn off the projector and unplug the power cord.

- To remove dust or dirt, use a soft, dry, lint-free cloth.
- To remove stubborn dirt, use a soft cloth moistened with water and mild soap. Do not spray liquid directly on the projector.

Attention

Do not use wax, alcohol, benzene, paint thinner, or other chemicals to clean the projector case. These can damage the case. Do not use canned air, or the gases may leave a flammable residue.

Regular filter maintenance is important to maintain your projector. Clean the air filter when a message appears telling you the temperature inside the projector has reached a high level. It is recommended that you clean these parts over a 20,000-hour period. Clean them more often than this if you use the projector in an environment that is dustier than expected. (Assuming the projector is used in an atmosphere in which airborne particulate matter is 0.04 mg/m³ or less.)

Attention

If regular maintenance is not performed, your Epson projector will notify you when the temperature inside the projector has reached a high level. Do not wait until this warning appears to maintain your projector filter as prolonged exposure to high temperatures may reduce the life of your projector.

► Related Links

- "Cleaning the Air Filters and Intake Vents" [p.143](#)
- "Replacing the Air Filter" [p.145](#)

Cleaning the Air Filters and Intake Vents

You need to clean the projector's air filters in the following situations:

- The filter or vents get dusty.
- You see a message telling you to clean it.
- The projector's Filter indicator flashes orange.

1 Turn off the projector and unplug the power cord.

2 Carefully remove the dust using a vacuum cleaner or a brush.

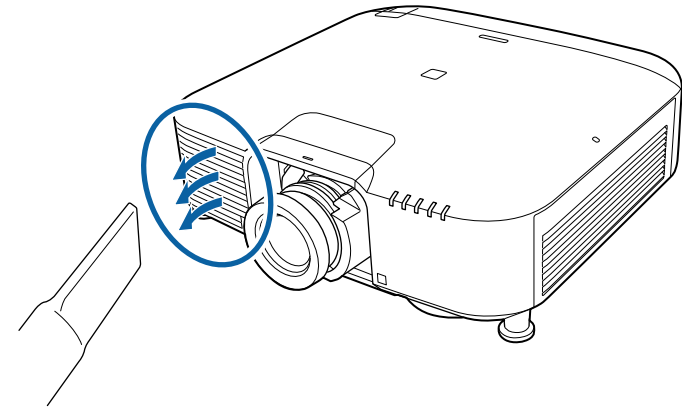

3 Loosen the screws and remove the air filter cover as shown (it is attached with a tether).

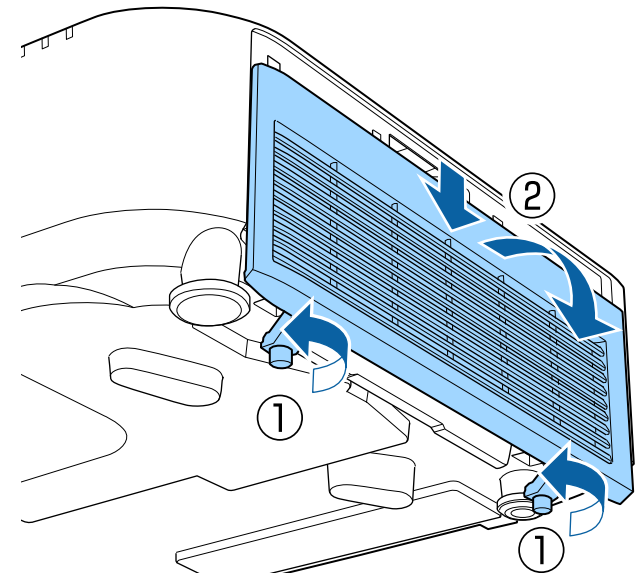

- 4** Pull the air filter out of the projector.

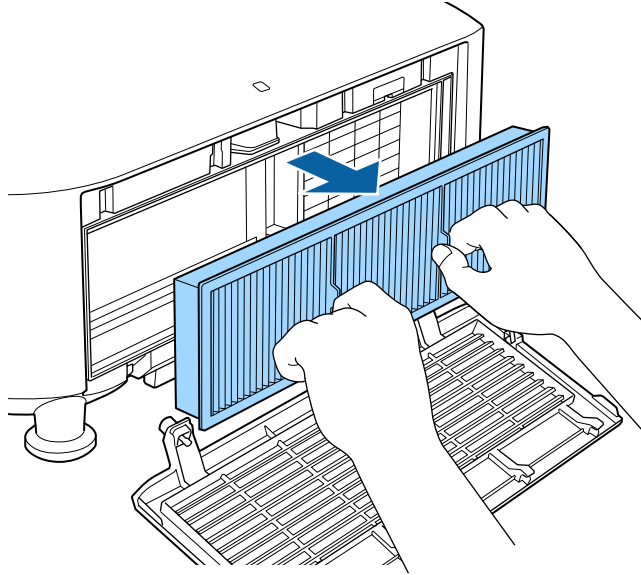

Attention

Do not use excessive force when tapping the air filter, or it may crack and become unusable.

- 6** Vacuum the front of the air filter (the side with the tabs) to remove any remaining dust.

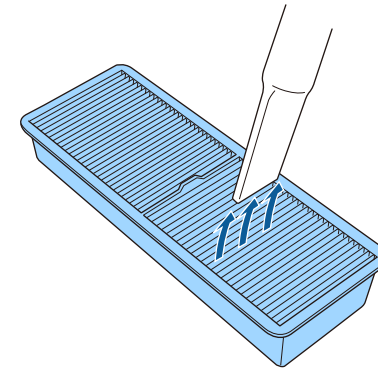

- 5** Tap each side of the air filter 4 to 5 times to shake off any excess dust.

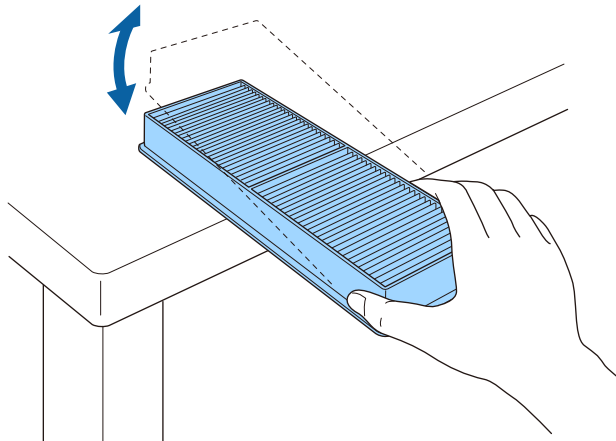

Attention

- Do not rinse the air filter in water, or use any detergent or solvent to clean it.
- Do not use canned air. The gases may leave a flammable residue or push dust and debris into the projector's optics or other sensitive areas.

- 7** Place the air filter in the projector as shown.

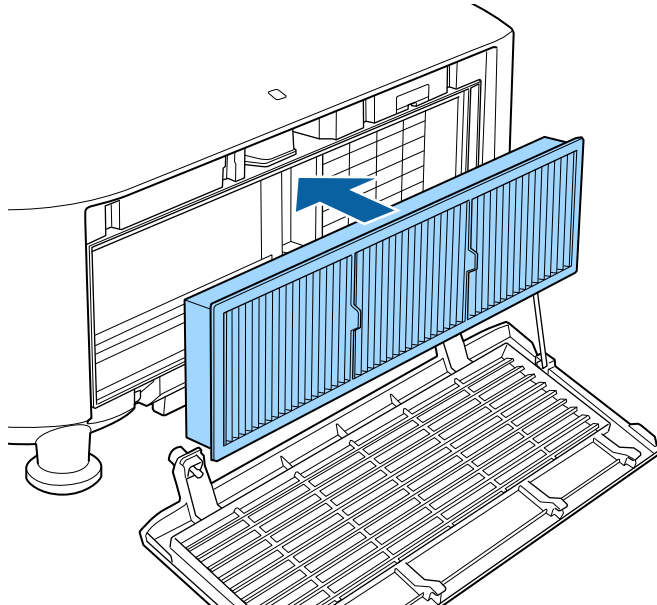

- 8** Replace the air filter cover as shown and tighten the screws.

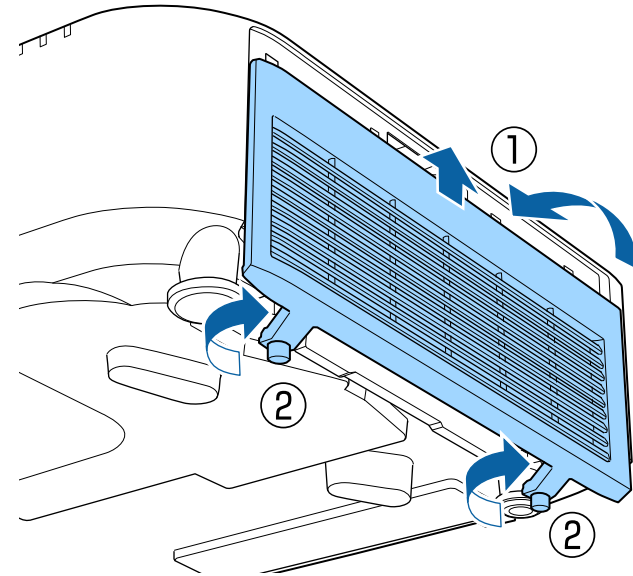

Replacing the Air Filter

You need to replace the air filter in the following situations:

- After cleaning the air filter, you see a message telling you to clean or replace it.
- The air filter is torn or damaged.

You can replace the air filter while the projector is mounted to the ceiling or placed on a table.

- 1** Turn off the projector and unplug the power cord.

2 Loosen the screws and remove the air filter cover as shown (it is attached with a tether).

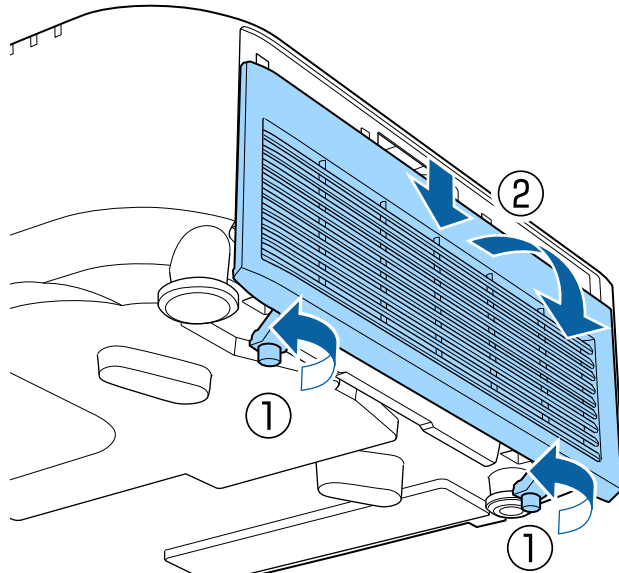

3 Pull the air filter out of the projector.

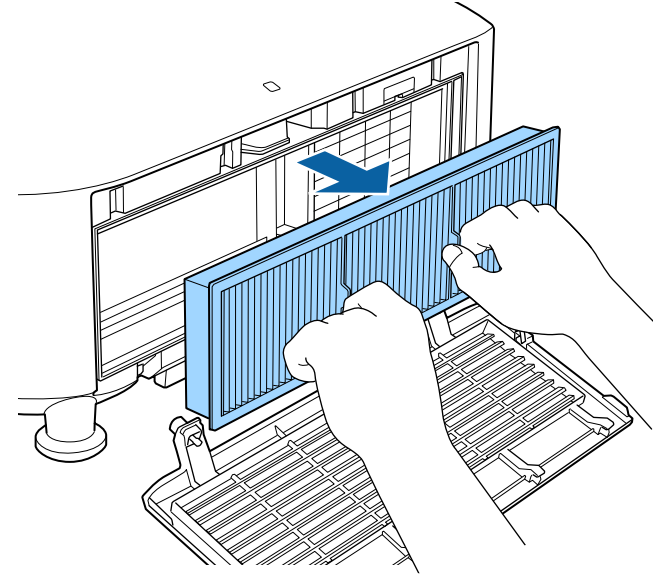

Dispose of used air filters according to local regulations.

- Filter frame: Polypropylene
- Filter: Polypropylene

4 Place the new air filter in the projector as shown.

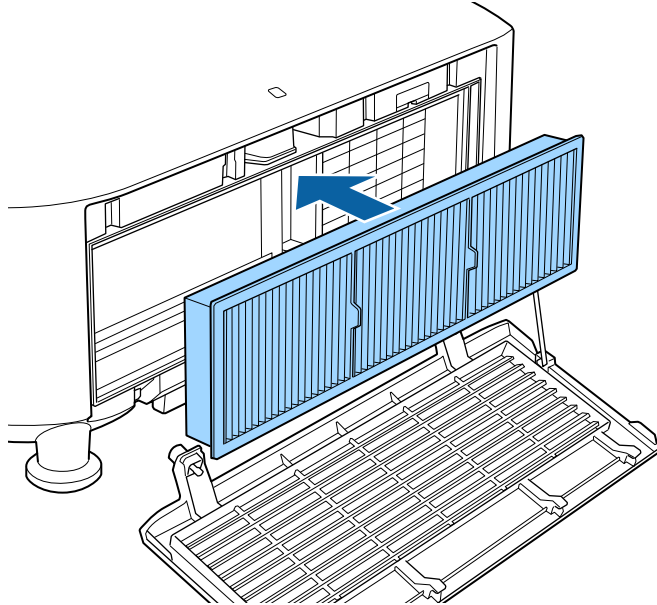

5 Replace the air filter cover as shown and tighten the screws.

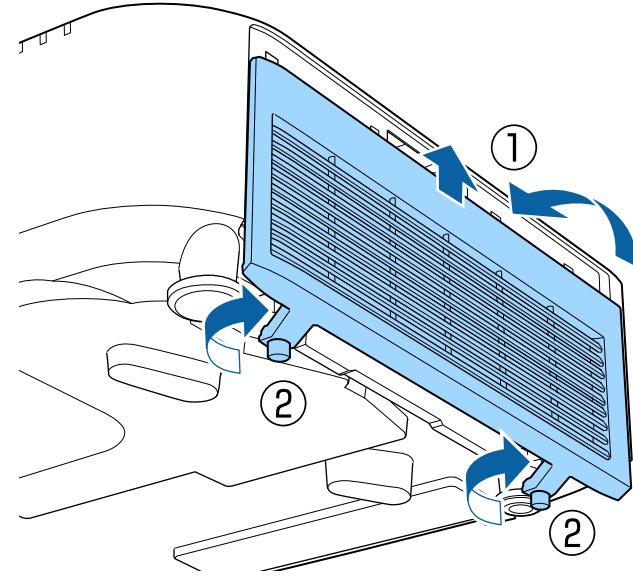

Solving Problems

Check the solutions in these sections if you have any problems using the projector.

► Related Links

- "Projection Problems" [p.149](#)
- "Projector Indicator Status" [p.150](#)
- "Projector Status Display Messages" [p.153](#)
- "Solving Image or Sound Problems" [p.157](#)
- "Solving Projector or Remote Control Operation Problems" [p.163](#)
- "Solutions to Problems in Content Playback Mode" [p.165](#)
- "Solving Network Problems" [p.166](#)

If the projector is not working properly, turn it off, unplug it, and then plug it back in and turn it on.

If this does not solve the problem, check the following:

- The indicators on the projector may indicate the problem.
- The Help option on the Home screen can display information about common problems, if the projector is operating.
- The solutions in this manual can help you solve many problems.

If none of these solutions help, contact Epson for technical support.

The indicators on the projector indicate the projector status and let you know when a problem occurs. Check the status and color of the indicators and then refer to this table for a solution.

- If the indicators display a pattern not listed in the table below, turn the projector off, unplug it, and contact Epson for help.
- When the **Indicators** setting is set to **Off** in the projector's **Extended** menu, all indicators are off under normal projection conditions.
Extended > Operation > Advanced > Indicators

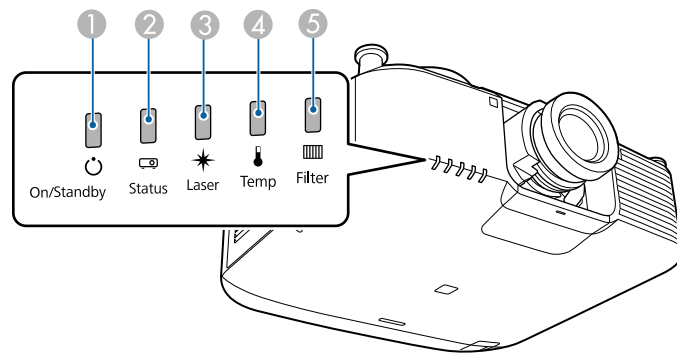

- ① Power indicator
- ② Status indicator
- ③ Laser indicator
- ④ Temp (temperature) indicator
- ⑤ Filter indicator

Projector status

Indicator and status	Problem and solutions
Power: Lit blue Status: Lit blue Laser: Indicator status varies Temp: Off Filter: Off	Normal operation.
Power: Lit blue Status: Flashing blue Laser: Indicator status varies Temp: Off Filter: Off	Warming up. When warming up, wait about 30 seconds for an image to appear. All buttons are disabled during warm-up.
Power: Lit blue Status: Flashing blue Laser: Off Temp: Off Filter: Off	Shutting down or cooling down. All buttons are disabled during shutting down and cooling down.
Power: Lit blue Status: Off Laser: Off Temp: Off Filter: Off	Standby, sleep mode, or monitoring. When you press the power button, projection starts.
Power: Flashing blue Status: Off Laser: Off Temp: Off Filter: Off	Preparing for monitoring or quick startup mode. All features are disabled.

Indicator and status	Problem and solutions
Power: Flashing blue Status: Off Laser: Off Temp: Off Filter: Off	Preparing to enter USB Power in Standby mode.
Power: Lit blue Status: Lit blue Laser: Flashing blue Temp: Off Filter: Off	A/V Mute is in progress.
Power: Indicator status varies Status: Flashing blue Laser: Flashing orange Temp: Indicator status varies Filter: Indicator status varies	Refresh Mode is in progress. ☛ Reset > Refresh Mode
Power: Flashing blue Status: Indicator status varies Laser: Indicator status varies Temp: Flashing orange Filter: Indicator status varies	Projector is too hot. <ul style="list-style-type: none"> • Make sure that the vents and air filter are not clogged with dust or obstructed by nearby objects. • Clean or replace the air filter. • Make sure the environmental temperature is not too hot.

Indicator and status	Problem and solutions
Power: Off Status: Flashing blue Laser: Off Temp: Lit orange Filter: Off	Projector has overheated and turned off. Leave it turned off to cool down for 5 minutes. <ul style="list-style-type: none"> • Make sure that the vents and air filter are not clogged with dust or obstructed by nearby objects. • Make sure the environmental temperature is not too hot. • Clean or replace the air filter. • If operating the projector at high altitude, set the High Altitude Mode setting to On in the projector's menu. ☛ Extended > Operation > High Altitude Mode • If the problem persists, unplug the projector and contact Epson for help.
Power: Flashing blue Status: Indicator status varies Laser: Flashing orange Temp: Indicator status varies Filter: Indicator status varies	Laser warning. Turn the projector off, unplug it, and contact Epson for help.
Power: Flashing blue Status: Indicator status varies Laser: Flashing orange Temp: Indicator status varies Filter: Indicator status varies	Lens warning. An unsupported lens is attached; remove the unsupported lens and attach a lens that is supported.
Power: Off Status: Flashing blue Laser: Lit orange Temp: Off Filter: Off	Laser or retardation plate has a problem. Turn the projector off, unplug it, and contact Epson for help.

Indicator and status	Problem and solutions
Power: Off Status: Flashing blue Laser: Off Temp: Flashing orange Filter: Off	A fan or sensor has a problem. Turn the projector off, unplug it, and contact Epson for help.
Power: Off Status: Flashing blue Laser: Flashing orange Temp: Off Filter: Off	Internal projector error. Turn the projector off, unplug it, and contact Epson for help.
Power: Indicator status varies Status: Indicator status varies Laser: Indicator status varies Temp: Indicator status varies Filter: Flashing orange	It is time to clean the air filter.
Power: Flashing blue Status: Indicator status varies Laser: Indicator status varies Temp: Indicator status varies Filter: Lit orange	Low air flow through the air filter. <ul style="list-style-type: none"> • Make sure that the vents and air filter are not clogged with dust or obstructed by nearby objects. • Clean or replace the air filter. • If the problem persists, unplug the projector and contact Epson for help.
Power: Off Status: Flashing blue Laser: Off Temp: Off Filter: Lit orange	Low air flow through the projector. <ul style="list-style-type: none"> • Make sure that the vents and air filter are not clogged with dust or obstructed by nearby objects. • Clean or replace the air filter. • If the problem persists, unplug the projector and contact Epson for help.

Indicator and status	Problem and solutions
Power: Off Status: Flashing blue Laser: Lit orange Temp: Lit orange Filter: Off	Lens Shift error Turn the projector off, unplug it, and contact Epson for help.
Power: Off Status: Flashing blue Laser: Lit orange Temp: Lit orange Filter: Off	A lens has a problem or no lens is installed. <ul style="list-style-type: none"> • Attach a lens. • If the lens is already attached, remove it and then reattach it. • If the problem persists, unplug the projector and contact Epson for help.
Power: Indicator status varies Status: Indicator status varies Laser: Flashing orange Temp: Indicator status varies Filter: Indicator status varies	The projector is unable to maintain constant brightness and the setting is disabled.  Settings > Brightness Settings > Constant Brightness

You can monitor the projector's status and view error information in the projector's **Info** menu.

 **Info > Status Information**

Categories on the status display let you view information about the projector and its operation.



- Status messages are available only in English.
- Items displayed vary depending on your projector model, the image signal, and the image source.

Status Information category

Information	Description
System	See the System status information table.
Source	Displays the source currently being used.
On-ScreenDisplay	Displays the settings for on-screen displays. When turned off, menus or messages are not displayed on the projected images.
A/V Mute	Displays the A/V Mute status.
Intake Air Temp	Displays the air intake temperature.
Internal Temp Lv	Displays the projector's internal temperature.
AC Voltage	Monitors the status of the input voltage, and displays a warning or an error when a momentary voltage drop occurs. Warnings and errors indicate the following status: <ul style="list-style-type: none"> Warning1: voltage drop Warning2: instantaneous interruption Error: power blockade When you turn off the projector by shutting off the power outlet (direct shutdown), an error is displayed. This is not an actual error.
ExtCam Status	Displays the operation status of the optional external camera.
Laser Status	Displays the operating status of the light source.

Source category

Information	Description
Source	Displays the source currently being used.
Resolution	Displays the resolution of the current input signal.
Color Space	Displays the color space of the current input signal.
H-Frequency	Displays the horizontal frequency of the current input signal.
V-Frequency	Displays the vertical frequency of the current input signal.
Sync Polarity	Displays the sync polarity.
Sync Mode	Displays the sync type.
Detected Mode	Displays the detected mode of the current input signal.
Video Range	Displays the video level of the projector.
Transport	Displays the scanning method.

Signal Information category

Information	Description
5V Detect	Displays the detection results of 5V signals.
TMDS Clock	Displays the TMDS frequency of the current input signal.
H-Frequency	Displays the horizontal frequency of the current input signal.
V-Frequency	Displays the vertical frequency of the current input signal.
Stable Time	Displays the amount of operating time since the input source was determined.
HDCP Status	Displays the HDCP status.
HDCP Ver	Displays the HDCP version.
AVI VIC	Displays the VIC information (AVI) of the current input signal.
AVI Checksum	Displays the checksum result for AVI.
AVI Sampling Str	Displays color sampling for AVI.

Information	Description
Signal Mode	Displays the signal mode.
HDR Mode	Displays the HDR mode.
EDID Mode	Displays the EDID mode.
HDBaseT Level	Displays the image signal information from the HDBaseT port.
SDI Link Mode	Displays the linking type for SDI.
Sync Detect	Displays the results of signal detection for each 3G/HD/SD SDI port.
PayloadID Detect	Displays the results of SDI payload ID detection.
Resolution	Displays the resolution.
Refresh Rate	Displays the refresh rate for SDI.
Color Sampling	Displays the color sampling.
Pixel Depth	Displays the color depth for SDI.
SDI Type	Displays the type of SDI.
3G Mapping Level	Displays the mapping level for 3G-SDI.
Color Space	Displays the color space conversion method.

Network Wired category

Information	Description
Projector Name	Displays the name used to identify the projector when connected to a network.
Connection Mode	Displays the connection path for the LAN.
DHCP	Displays the DHCP settings.
IP Display	Displays the IP address display settings.
IP Address	Displays the IP address.
MAC Address	Displays the MAC address.

Network Wireless category

Information	Description
Projector Name	Displays the name used to identify the projector when connected to a network.
Connection Mode	Displays the connection mode to use when connecting the projector and a computer over a wireless LAN.
SSID Display	Displays the SSID display settings.
SSID	Displays the SSID.
DHCP	Displays the DHCP settings.
IP Display	Displays the IP address display settings.
IP Address	Displays the IP address.
MAC Address	Displays the MAC address.
Security	Displays the security settings.
Antenna Level	Displays the reception status for Wi-Fi.

Maintenance category

Information	Description
Operation Time	Displays the projector's total operation time.
Laser Op. Time	Displays the laser operating time for each Light Source Mode setting.

Version category

Information	Description
Serial No.	Displays the projector's serial number.

Information	Description
Main	Display the projector's firmware version information.
Video2	
Sub	
Sub2	
HDMI	
HDMI2	
HDBaseT	

System status information

Status	Description
OK	The projector is in normal operating mode.
Warm-up	The projector is warming up.
Standby	The projector is in standby mode.
Cool Down	The projector is cooling down.

Status	Description
Temp Error	<p>A high temperature error occurred.</p> <p>You can check the following status in the Epson Projector Management software or the Projector Config Tool app.</p> <ul style="list-style-type: none"> • Temp Error 2A • Temp Error 2B • Temp Error 2C • Temp Error 03 • Temp Error 12 • Temp Error 2F • Temp Error 30 • Temp Error 1D • Temp Error 0C • Temp Error 23 • Temp Error 32 • Temp Error 4B • Temp Error 4C • Temp Error 09 • Temp Error 38 • Temp Error 63 • Temp Error 64 • Temp Error 25 • Temp Error 26 • Temp Error 24 • Temp Error 6F • Temp Error FE <p>The device ID number might also be displayed.</p>
Fan Error	<p>A fan error occurred.</p> <p>You can check the following status in the Epson Projector Management software or the Projector Config Tool app.</p> <ul style="list-style-type: none"> • Fan Error 01 (LV1) • Fan Error 11 (LV2) • Fan Error 04 (PBS) • Fan Error 07 (EX) • Fan Error 22 (LD) • Fan Error 14 (PS) • Fan Error 17 (PS2) • Fan Error 1F (PHW) <p>The device ID number might also be displayed.</p>

Status	Description
Sensor Error	<p>A sensor error occurred.</p> <p>You can check the following status in the Epson Projector Management software or the Projector Config Tool app.</p> <ul style="list-style-type: none"> • Sensor Error 2A(LVR) • Sensor Error 2B(LVG) • Sensor Error 2C(LVB) • Sensor Error 03(PBS) • Sensor Error 12(PHW) • Sensor Error 2F(LD1) • Sensor Error 30(LD2) • Sensor Error 1D(PS1) • Sensor Error 0C(PS2) • Sensor Error 23(PFC) • Sensor Error 32(PFC2) • Sensor Error 4B(LDDR1) • Sensor Error 4C(LDDR2) • Sensor Error 09(AIR1) • Sensor Error 38(AIR2) • Sensor Error 63(RGB-R) • Sensor Error 64(RGB-B) • Sensor Error 25(VIC) • Sensor Error 26(SML) • Sensor Error 24(HDBT) • Sensor Error 6F(HDMI) <p>The device ID number might also be displayed.</p>

Status	Description
Internal Error	<p>An internal error occurred.</p> <p>You can check the following status in the Epson Projector Management software or the Projector Config Tool app.</p> <ul style="list-style-type: none"> • Internal Error 01 • Internal Error 02 • Internal Error 03 • Internal Error 12 • Internal Error 0C • Internal Error 0F • Internal Error 10 • Internal Error 13 • Internal Error 07 • Internal Error 0A • Internal Error 14 • Internal Error 11 <p>The device ID number might also be displayed.</p>
Airflow Error	A filter airflow error occurred.
Temp Warning	A high temperature warning occurred.
Airflow Decline	A low airflow error occurred.
Clean Filter	An air filter notice occurred; clean the air filter.
Lens Shift Error	A lens shift error has occurred.
Lens Error	A lens error has occurred.
Laser Error	A laser error has occurred.
Laser Warning	A laser warning has occurred.
Temp Error FE	A laser error has occurred because the laser temperature is too high.
Temp Warning FE	A laser warning has occurred because the laser temperature is too high.

Check the solutions in these sections if you have any problems with projected images or sound.

► Related Links

- "Solutions When No Image Appears" [p.157](#)
- "Solutions When "No Signal" Message Appears" [p.157](#)
- "Solutions When "Not Supported" Message Appears" [p.158](#)
- "Solutions When Only a Partial Image Appears" [p.158](#)
- "Solutions When the Image is not Rectangular" [p.159](#)
- "Solutions When the Image Contains Noise or Static" [p.159](#)
- "Solutions When the Image is Fuzzy or Blurry" [p.159](#)
- "Solutions When the Image Brightness or Colors are Incorrect" [p.160](#)
- "Solutions When Automatic Adjustments are not Applied Correctly" [p.160](#)
- "Solutions When Simple Stacking is not Applied Correctly" [p.161](#)
- "Solutions When an Afterimage Remains on the Projected Image" [p.161](#)
- "Solutions to Sound Problems" [p.161](#)

Solutions When No Image Appears

If no image appears, try the following solutions:

- Press the [A/V Mute] button on the remote control to see if the image was temporarily turned off.
- Make sure all necessary cables are securely connected and the power is on for the projector and connected video sources.
- Press the projector's power button to wake it from standby or sleep mode. Also, check if the connected computer is in sleep mode or displaying a blank screen saver.
- If the projector does not respond when you press the control panel buttons, the buttons may be locked for security. Unlock the buttons in the **Control Panel Lock** setting or use the remote control to turn on the projector.
 - ☛ **Settings > Lock Setting > Control Panel Lock**
- If the projector does not respond when you press any buttons on the projector, an internal error may have occurred in the projector. Contact Epson for help.
- Adjust the **Brightness** setting in the projector's **Image** menu.

- Adjust the brightness of your projector's light source.
 - ☛ **Settings > Brightness Settings**
- Make sure **Messages** is set to **On** in the projector's **Extended** menu.
 - ☛ **Extended > Display > Messages**
- The projector may not be able to project copyrighted videos that you play back on a computer. For more details, see the manual supplied with the computer.
- For images projected with Windows Media Center, reduce the screen size from full screen mode.
- For images projected from applications using Windows DirectX, turn off DirectX functions.

Solutions When "No Signal" Message Appears

If the "No Signal" message appears, try the following solutions:

- Press the [Search] (remote control) or [Source Search] (control panel) button on the control panel or remote control until you see the image from the source you want.
- Turn on the connected computer or video source, and press play to begin your presentation, if necessary.
- Check that all cables required for projection are securely connected.
- If you are projecting from a laptop computer, make sure it is set up to display on an external monitor.
- If necessary, turn off the projector and the connected computer or video source, and then turn them back on.
- If you are projecting from an HDMI source, replace the HDMI cable with the shorter one.

► Related Links

- "Displaying From a Windows Laptop" [p.158](#)
- "Displaying From a Mac Laptop" [p.158](#)

Displaying From a Windows Laptop

If the message "No Signal" is displayed when projecting from a laptop, you need to set up the Windows laptop to display on an external monitor.

- 1** Hold down the Windows key and press **P** on your keyboard at the same time, then click **Duplicate**.
- 2** If the same image is not displayed by the laptop and projector, check the Windows **Display** utility to make sure the external monitor port is enabled and extended desktop mode is disabled.
- 3** If necessary, check your video card settings and set the multiple display option to **Mirror** or **Duplicate**.

Displaying From a Mac Laptop

If the message "No Signal" is displayed when projecting from a Mac laptop, you need to set up the laptop for mirrored display. (See your laptop manual for details.)

- 1** Open the **System Preferences** utility and select **Displays**.
- 2** Select the **Display** or **Color LCD** option, if necessary.
- 3** Click the **Arrange** or **Arrangement** tab.
- 4** Select **Mirror Displays**.

Solutions When "Not Supported" Message Appears

If the message "Not supported" is displayed, try the following solutions:

- Make sure the computer's display resolution does not exceed the projector's resolution and frequency limits. If necessary, select a different display resolution for your computer.

Solutions When Only a Partial Image Appears

If only a partial computer image appears, try the following solutions:

- If you are projecting from a computer using a VGA computer cable, press the [Auto] button on the remote control to optimize the image signal.
- Make sure you selected the correct **Screen Type** setting for the screen you are using.
 - ☛ **Extended > Display > Screen > Screen Type**If there are margins between the edge of the image and the projected screen frame, adjust the position of the image.
 - ☛ **Extended > Display > Screen > Screen Position**
- Make sure the **Scale** setting is turned off in the projector's **Signal** menu.
- Try adjusting the image position using the **Position** setting in the projector's **Signal** menu.
- Press the [Aspect] button on the remote control to select a different image aspect ratio.
- Change the **Resolution** setting in the projector's **Signal** menu according to the signal for the connected equipment.
- Change the **Blanking** setting in the projector's **Signal** menu so that the image appears as you expect.
- If you zoomed into or out of the image using the [E-Zoom] buttons, press the [Esc] button until the projector returns to a full display.
- Check your computer display settings to disable dual display and set the resolution within the projector's limits.
- Check the resolution assigned to your presentation files to see if they are created for a different resolution.
- When projecting in Content Playback mode, make sure you are using the appropriate **Overlay Effect** settings.
 - ☛ **Settings > Content Playback > Overlay Effect**
- Make sure you selected the correct **Projection** setting in the projector's **Extended** menu.

Solutions When the Image is not Rectangular

If the projected image is not evenly rectangular, try the following solutions:

- Place the projector directly in front of the center of the screen, facing it squarely, if possible.
- Press the [Geometry] button on the control panel or remote control to adjust the image shape.
- Adjust the **H/V-Keystone** setting to correct the image shape.
 - ☛ **Settings > Geometry Correction > H/V-Keystone**
- Adjust the **Quick Corner** setting to correct the image shape.
 - ☛ **Settings > Geometry Correction > Quick Corner**
- Adjust the **Curved Surface** setting to correct the corners and sides of an image projected on a curved surface with the same radius.
 - ☛ **Settings > Geometry Correction > Corner Wall**
- Adjust the **Corner Wall** setting to correct the corners and sides of an image projected on a curved surface with right angles.
 - ☛ **Settings > Geometry Correction > Curved Surface**
- Adjust the **Point Correction** setting to correct slight distortion which occurs partially.
 - ☛ **Settings > Geometry Correction > Point Correction**

Solutions When the Image Contains Noise or Static

If the projected image contains electronic interference (noise) or static, try the following solutions:

- Check the cables connecting your computer or video source to the projector. They should be:
 - Separated from the power cord to prevent interference
 - Securely connected at both ends
 - Not connected to an extension cable
- Check the settings in the projector's **Signal** menu to make sure they match the video source.

- Adjust the **Image Enhancement** settings in the projector's **Image** menu.
 - ☛ **Image > Image Enhancement > Noise Reduction**
 - ☛ **Image > Image Enhancement > MPEG Noise Reduction**
 - ☛ **Image > Image Enhancement > Deinterlacing**
- Set the **Resolution** setting to **Auto** in the projector's **Signal** menu.
- Select a computer video resolution and refresh rate that are compatible with the projector.
- If you are projecting from a computer using a VGA computer cable, press the [Auto] button on the remote control to automatically adjust the **Tracking** and **Sync.** settings. If the images are not adjusted correctly, manually adjust the **Tracking** and **Sync.** settings in the projector's **Signal** menu.
- If you adjusted the image shape using the projector controls, try decreasing the **Sharpness** setting in the projector's **Image** menu to improve image quality.
- If you connected an extension power cable, try projecting without it to see if it caused interference in the signal.
- Make sure you selected the correct **Video Range** or **EDID** setting in the projector's **Signal** menu, if available for your image source.
 - ☛ **Signal > Advanced > Video Range**
 - ☛ **Signal > Advanced > EDID**

Solutions When the Image is Fuzzy or Blurry

If the projected image is fuzzy or blurry, try the following solutions:

- Adjust the image focus.
- Position the projector close enough to the screen.
- Position the projector so the keystone adjustment angle is not so wide that it distorts the image.
- Clean the projector lens.



To avoid condensation on the lens after bringing the projector in from a cold environment, let the projector warm up to room temperature before using it.

- Adjust the **Sharpness** setting in the projector's **Image** menu to improve image quality.
- If you are projecting from a computer using a VGA computer cable, press the [Auto] button on the remote control to automatically adjust the **Tracking** and **Sync.** settings. If any bands or overall blurriness remain, display a uniformly patterned image on the screen and manually adjust the **Tracking** and **Sync.** settings in the projector's **Signal** menu.
- If you are projecting from a computer, use a lower resolution or select a resolution that matches the projector's native resolution.

Solutions When the Image Brightness or Colors are Incorrect

If the projected image is too dark or light, or the colors are incorrect, try the following solutions:

- Press the [Color Mode] button on the remote control to try different color modes for the image and environment.
- Check your video source settings.
- Adjust the available settings in the projector's **Image** menu for the current input source, such as **Brightness**, **Contrast**, **Tint**, and **Color Saturation**.
- Make sure you selected the correct **Video Range** or **EDID** setting in the projector's **Signal** menu, if available for your image source.
 - ☛ **Signal > Advanced > Video Range**
 - ☛ **Signal > Advanced > EDID**
- Make sure you selected the correct **RGBCMY** setting in the projector's **Image** menu.
 - ☛ **Image > Advanced > RGBCMY**
- Make sure all the cables are securely connected to the projector and your video device. If you connected long cables, try connecting shorter cables.

- Make sure **Brightness Settings** are set correctly.
 - ☛ **Settings > Brightness Settings**
- Position the projector close enough to the screen.
- When using multiple projectors, make sure **Light Source Calibration** in the **Reset** menu is set correctly in all of the projectors. If light source calibration is performed only in some of the projectors, the white balance and the brightness level of the projected image may differ between the projectors.

Solutions When Automatic Adjustments are not Applied Correctly

If you have problems with automatic adjustments not being applied correctly, try the following solutions:

- Be sure to wait at least 20 minutes after turning on the projector before performing automatic adjustments. This gives the projector's temperature a chance to stabilize.
- Check that the camera area is clean.
- Make sure the cable of the optional external camera is securely connected to the projector.
- The optional external camera may be defective. Contact Epson for help.
- Depending on the lens you installed, automatic adjustments may not be available. Automatic adjustment is not available for the following lenses: ELPLR04, ELPLL07, ELPLL08.
- If you are projecting from an analog input source, the changing color and brightness of the image may cause automatic adjustments to not be applied correctly.
- Make sure that a powerful spotlight or source of strong natural light is not shining into the projection environment and interfering with automatic adjustments.
- Check that your image correction and image blending settings are within reasonable ranges. If the projection angle is very large, try turning off the **Geometry Correction** setting or reduce the projection angle. If you are

using the **Edge Blending** setting, make sure the blending width is between 15 to 43%.

- If you see an error message during automatic adjustments, check the error codes in the message.

During Screen Matching:

- 0101: Measurement value error
- 0102: Measurement failure
- 0103: Switch camera failure
- 0104/0105: Model mismatch
- 0108: Camera error

During Color Matching:

- 0201: Measurement value error
- 0202: Measurement failure
- 0203: Switch camera failure
- 0208: Camera error

Contact Epson for support for details.

Solutions When Simple Stacking is not Applied Correctly

If you have problems with simple stacking not being applied correctly, try the following solutions:

- Make sure the projectors are placed correctly and connected using a LAN cable.
- Make sure the optional external camera is installed correctly and the cable is securely connected to the projector.
- The optional external camera may be defective. Contact Epson for help.
- Depending on the lens you installed, simple stacking may not be available. Simple stacking is not available for the following lenses: ELPLL07, ELPLL08.

- Make sure that a powerful spotlight or source of strong natural light is not shining into the projection environment and interfering with simple stacking.
- Resize the projection size.
- If you see an error message during the simple stacking process, check the error codes in the message.
 - 0302: Measurement failure
 - 0306: Geometry correction error
 - 0308: Communication errorContact Epson for support for details.

► Related Links

- "Conditions for Simple Stacking" [p.99](#)

Solutions When an Afterimage Remains on the Projected Image

If you see an afterimage in the projected image, use the **Refresh Mode** feature to clear it. Select **Refresh Mode** > **Start** in the projector's **Reset** menu.

Solutions to Sound Problems

If there is no sound or the volume is too low or high, try the following solutions:

- Adjust the projector's volume settings.
- Press the [A/V Mute] button on the remote control to resume video and audio if they were temporarily stopped.
- Check your computer or video source to make sure the volume is turned up and the audio output is set for the correct source.
- Check the audio cable connections between the projector and your video source.
- Make sure any connected audio cables are labeled "No Resistance".

- If you want to use a connected audio source when the projector is off, set the **Standby Mode** option to **Communication On** and make sure the **A/V Settings** options are set correctly in the projector's **Extended** menu.
- If you want to output audio from a connected audio source when the projector does not project any images, select these settings in the projector's menus:
 - Turn off **Quick Startup** in the **Extended** menu.
 - ☛ **Extended > Operation > Quick Startup**
 - Set the **A/V Output** setting to **Always On** in the **Extended** menu.
 - ☛ **Extended > A/V Settings > A/V Output**
- If you do not hear sound from an HDMI source, set the connected device to PCM output.
- When you are connecting the projector to a Mac using an HDMI cable, make sure your Mac supports audio through the HDMI port. If not, you need to connect an audio cable.
- If the volume for the computer is set to the minimum while the projector is set to the maximum, the noise may be mixed. Turn up the computer's volume and turn down the projector's volume. (When you use Epson iProjection (Windows/Mac).)

Check the solutions in these sections if you have problems operating the projector or remote control.

► Related Links

- "Solutions to Projector Power or Shut-Off Problems" [p.163](#)
- "Solutions to Problems with the Remote Control" [p.163](#)
- "Solutions to Password Problems" [p.164](#)
- "Solution When "The Battery that Saves Your Clock Settings is Running Low" Message Appears" [p.164](#)

Solutions to Projector Power or Shut-Off Problems

If the projector does not turn on when you press the power button or it turns off unexpectedly, try the following solutions:

- Make sure the power cord is securely connected to the projector and to a working electrical outlet.
- If the power button on the remote control does not turn on the projector, check its batteries and make sure at least one of the remote receivers are available in the **Remote Receiver** setting in the projector's **Settings** menu.
- The projector's buttons may be locked for security. Unlock the buttons in the **Control Panel Lock** setting or use the remote control to turn on the projector.
- If the projector's light source turns off unexpectedly, it may have entered sleep mode after a period of inactivity. Perform any operation to wake the projector. To turn off sleep mode, set the **Sleep Mode** setting to **Off**.
☛ **Extended** > **Operation** > **Sleep Mode**
- If the projector's light source turns off unexpectedly, the A/V mute timer may be enabled. To turn off the A/V mute timer, set the **A/V Mute Timer** setting to **Off**.
☛ **Extended** > **Operation** > **A/V Mute Settings** > **A/V Mute Timer**
- If the projector's light source turns off, the status indicator is flashing, and the temp (temperature) indicator is lit, the projector has overheated and turned off.

- The cooling fans may run in standby status depending on the projector settings. Also, when the projector wakes from standby status, the fans may cause an unexpected noise. This is not a malfunction.
- The power cord may be defective. Disconnect the cord and contact Epson for help.

Solutions to Problems with the Remote Control

If the projector does not respond to remote control commands, try the following solutions:

- Check that the remote control batteries are installed correctly and have power. If necessary, replace the batteries.
- Make sure you are operating the remote control within the reception angle and range of the projector.
- Make sure the projector is not warming up or shutting down.
- Check to see if a button on the remote control is stuck down, causing it to enter sleep mode. Release the button to wake the remote control up.
- Strong fluorescent lighting, direct sunlight, or infrared device signals may be interfering with the projector's remote receivers. Dim the lights or move the projector away from the sun or interfering equipment.
- Make sure at least one of the remote receivers are available in the **Remote Receiver** setting in the projector's **Settings** menu.
- If you enabled the remote control button lock, press and hold the [Home] button for about 5 seconds to turn it off.
- If you assigned an ID number to the projector to operate multiple projectors from the remote control, you may need to check or change the ID setting.
- Set the remote control [ID] switch to **Off**. You can operate all of the projectors regardless of the projector ID settings.
- Make sure the optional remote control cable set is not attached to the projector's Remote port. If you leave the cable connected to the port, the remote control cannot control the projector.

- Make sure the **Control Communications** or **Extron XTP** setting in the **Extended** menu is set to **Off** if you are using the optional remote control cable set.
 - ☛ **Extended > HDBaseT > Control Communications**
 - ☛ **Extended > HDBaseT > Extron XTP**
- If you lose the remote control, you can order another one from Epson.

Solutions to Password Problems

If you cannot enter or remember a password, try the following solutions:

- You may have turned on password protection without first setting a password. Try entering **0000** using the remote control.
- If you have entered an incorrect password too many times and see a message displaying a request code, write down the code and contact Epson for help. Provide the request code and proof of ownership for assistance in unlocking the projector.
- If you set an Epson Web Control password and forgot the user ID or password, try entering the following:
 - User ID: **EPSONWEB**
 - Default password: the projector's serial number
- If you set a Remote password (in Epson Web Control) and forgot the user ID or password, try entering the following:
 - User ID: **EPSONREMOTE**
 - Default password: the projector's serial number
- If you lose the remote control you cannot enter a password. Order a new one from Epson.

Solution When "The Battery that Saves Your Clock Settings is Running Low" Message Appears

If the message "The battery that saves your clock settings is running low." is displayed, contact Epson for help.

If you cannot play back a playlist correctly, try the following solutions:

- Make sure **Content Playback** is set to **On**.
☛ **Settings > Content Playback > Content Playback**
- Make sure the USB flash drive contains a playlist.
- Make sure the USB flash drive is directly connected to the projector. Do not use a multi-card reader or a USB hub to expand a USB port.
- If the USB flash drive is partitioned, you may not be able to play back playlists. Delete all of the partitions before saving the playlists on the USB flash drive.
- Do not share a playlist between projectors that are different in resolution. Color and shape effects added by using **Overlay Effect** may not be reproduced correctly.
☛ **Settings > Content Playback > Overlay Effect**

Check the solutions in these sections if you have problems using the projector on a network.

► Related Links

- "Solutions When Wireless Authentication Fails" [p.166](#)
- "Solutions When You Cannot Access the Projector Through the Web" [p.166](#)
- "Solutions When Network Alert E-Mails are not Received" [p.166](#)
- "Solutions When the Image Contains Static During Network Projection" [p.167](#)
- "Solutions When You Cannot Monitor and Control the Projector over a Network" [p.167](#)

Solutions When Wireless Authentication Fails

If you are having trouble with the authentication, try the following solutions:

- If the wireless settings are correct, but authentication fails, you may need to update the **Date & Time** settings.
 - ☛ **Extended > Operation > Date & Time**
- Check the **Security** settings in the projector's **Network** menu.
 - ☛ **Network > Network Configuration > Wireless LAN**
- If the access point security is WPA3-EAP, change the access point setting to WPA2/WPA3-EAP.

Solutions When You Cannot Access the Projector Through the Web

If you are unable to access the projector through a Web browser, make sure you are using the correct ID and password.

- For the user ID, enter **EPSONWEB**. (You cannot change the user ID.)
- For the password, enter the password set in the projector's **Network** menu. The default password is the projector's serial number.
- Make sure you have access to the network the projector is on.

- If your Web browser is set up to connect via a proxy server, the **Epson Web Control** screen cannot be displayed. Make settings for a connection without using a proxy server.
- If you set the **Standby Mode** setting to **Communication On** in the projector's menu in standby mode, make sure the network device is turned on. After turning on the network device, turn on the projector.
 - ☛ **Extended > Standby Mode**
And connect to a wired LAN, or to a wireless LAN with the **Connection Mode** setting set to **Advanced**.
 - ☛ **Network > Network Configuration > Wireless LAN > Connection Mode**



The user ID and password are case sensitive.

Solutions When Network Alert E-Mails are not Received

If you do not receive an e-mail alerting you to problems with a projector over the network, try the following solutions:

- Make sure the projector is turned on and connected to the network correctly. (If an error shuts down the projector, the email may not be delivered.)
- Make sure you set up the projector e-mail alert settings correctly in the projector's network **Notifications** menu or in the network software.
- Set the **Standby Mode** setting to **Communication On** so that the network software can monitor the projector in standby mode.
 - ☛ **Extended > Standby Mode**
And connect to a wired LAN, or to a wireless LAN with the **Connection Mode** setting set to **Advanced**.
 - ☛ **Network > Network Configuration > Wireless LAN > Connection Mode**

Solutions When the Image Contains Static During Network Projection

If the projected image contains static during network projection, try the following solutions:

- Check for any obstacles between the access point, the computer, the mobile device, and the projector, and change their positions to improve communication.
- Make sure that the access point, the computer, the mobile device and the projector are not too far apart. Move them closer together and try to connect again.
- Check for interference from other equipment, such as a Bluetooth device or microwave. Move the interfering device farther away or expand your wireless bandwidth.
- Reduce the number of connected devices if the connection speed declines.

Solutions When You Cannot Monitor and Control the Projector over a Network

If you are unable to monitor and control the projector with command communication using ESC/VP.net, set the **Command Communication** setting to **Compatible**.

☛ **Network > Network Configuration > Others > Command Communication**

Appendix

Check these sections for the technical specifications and important notices about your product.

► **Related Links**

- "Optional Accessories and Replacement Parts" [p.169](#)
- "Screen Size and Projection Distance" [p.171](#)
- "Projector Specifications" [p.180](#)
- "Supported Features for Epson Projector Content Manager" [p.183](#)
- "List of Safety Symbols and Instructions" [p.184](#)
- "Laser Safety Information" [p.186](#)
- "Hazard Distance according to IEC62471-5" [p.188](#)
- "Notices" [p.189](#)

The following optional accessories and replacement parts are available. Please purchase these products as and when needed.

The following list of optional accessories and replacement parts is current as of: April 2021.

Details of accessories are subject to change without notice and availability may vary depending on the country of purchase.

► Related Links

- "Lens" [p.169](#)
- "Cables" [p.169](#)
- "Mounts" [p.170](#)
- "External Devices" [p.170](#)
- "Replacement Parts" [p.170](#)
- "For Wireless Connection" [p.170](#)

Lens

ELPLX01/01S *

ELPLX01W/01WS *

ELPLX02/02S **

ELPLX02W/02WS **

Ultra short-throw zoom lens.

ELPLU02

ELPLU03S

ELPLU04

Short-throw zoom lens.

ELPLW04

ELPLW05

ELPLW06

ELPLW08

Wide-throw zoom lens.

ELPLM06

ELPLM07

ELPLM08 *

ELPLM09

ELPLM10

ELPLM11

ELPLM15

Middle-throw zoom lens.

ELPLL07

ELPLL08

Long-throw zoom lens.

ELPLR04

Rear projection wide lens.

ELPLS04

Standard zoom lens.

* Available only for

EB-PU1008B/EB-PU1008W/EB-PU1007B/EB-PU1007W/EB-PU1006W.

** Available only for EB-PU2010B/EB-PU2010W.

Cables

Computer cable ELPKC02 (1.8 m - for mini D-sub 15-pin/mini D-Sub 15pin)

Computer cable ELPKC09 (3 m - for mini D-sub 15-pin/mini D-Sub 15pin)

Computer cable ELPKC10 (20 m - for mini D-sub 15-pin/mini D-Sub 15pin)

Use when connecting to the Computer port.

Remote Control Cable Set ELPKC28

Use when connecting multiple projectors that support the interactive feature.

Mounts

Ceiling Mount ELPMB67

Use when installing the projector on a ceiling.

Low ceiling mount ELPMB47

Use when installing the projector on a low ceiling.

High ceiling mount ELPMB48

Use when installing the projector on a high ceiling.

Suspension Adapter (450 mm) ELPP15

Use when installing the projector on a high ceiling.

Polarizer ELPPL01

Use when stacking two projectors and projecting 3D images.



Special expertise is required to suspend the projector from a ceiling.
Contact Epson for help.

Replacement Parts

Air filter ELPAF46

Use as a replacement for used air filters.

For Wireless Connection

Wireless LAN module ELPAP11

Use this to project images from a computer via a wireless communication.

Wireless Presentation System ELPWP20

Use when directly connecting to Windows/Mac computers and projecting images wirelessly. Includes two wireless transmitters (ELPWT01) and one base unit (ELPBU01).

Wireless Transmitter ELPWT01

Additional wireless transmitter for wireless presentation system.

External Devices

Document Camera ELPDC21

Use when projecting image such as books, OHP documents, or slides.

HDBaseT Transmitter ELPHD01

Use when sending an HDMI signal over a long distance. (HDCP 2.2 is not supported)

Android TV™ device ELPAP12

Use this streaming media player to watch online content.

External Air filter ELPAF63

Attach this to the outside of the projector when using the projector in a dusty environment.

External Camera ELPEC01

Attach this to use extended functions such as the Camera Assist function.

Check the tables in these sections to determine how far to place the projector from the screen based on the size of the projected image.

► **Related Links**

- "Projection Distance" [p.171](#)

Projection Distance

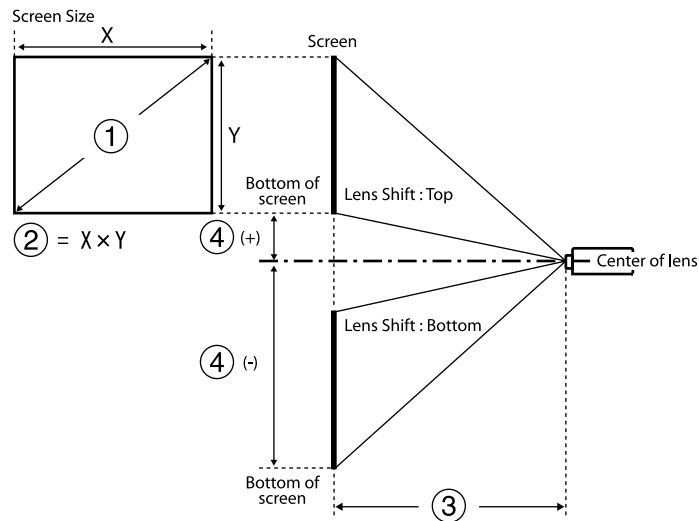

- ① Screen size (inches)
- ② Screen size (Width × Height) (cm)
- ③ Projection distance (Minimum: Wide to Maximum: Tele) (cm)
- ④ Distance from the center of the lens to the bottom of the screen (cm)

EB-PU2010B/EB-PU2010W:

16:10

①	②	③	④
Inches	Width × Height	ELPLX02 ELPLX02S ELPLX02W ELPLX02WS	
100	215 × 135	74	-7 - 27
120	258 × 162	89	-8 - 32
150	323 × 202	112	-10 - 40
200	431 × 269	151	-13 - 54
300	646 × 404	228	-20 - 81
400	862 × 538	306	-27 - 108
500	1077 × 673	383	-34 - 135
600	1292 × 808	460	-40 - 162
800	1723 × 1077	615	-54 - 215
1000	2154 × 1346	769	-67 - 269

①	②	③					
Inches	Width × Height	ELPLU02 ELPLU04	ELPLU03 S	ELPLW0 4 ELPLW0 6	ELPLW0 5	ELPLW0 8	ELPLM0 6 ELPLM1 0
60	129 × 81	80 - 97	-	149 - 206	94 - 135	109 - 154	306 - 473
80	172 × 108	108 - 131	80 - 97	202 - 277	129 - 182	146 - 206	413 - 635
100	215 × 135	136 - 165	101 - 123	254 - 348	163 - 229	184 - 259	519 - 797
120	258 × 162	165 - 199	122 - 148	306 - 419	197 - 276	222 - 312	626 - 959

①	②	③					
Inches	Width × Height	ELPLU02 ELPLU04	ELPLU03 S	ELPLW0 4 ELPLW0 6	ELPLW0 5	ELPLW0 8	ELPLM0 6 ELPLM1 0
150	323 × 202	207 - 251	154 - 186	385 - 526	248 - 347	278 - 391	786 - 1202
200	431 × 269	278 - 336	206 - 249	515 - 703	333 - 464	372 - 524	1052 - 1607
250	538 × 337	349 - 421	259 - 312	646 - 881	418 - 582	466 - 656	1318 - 2012
300	646 × 404	420 - 507	311 - 374	777 - 1058	504 - 699	560 - 788	1585 - 2417
500	1077 × 673	704 - 848	521 - 626	1299 - 1769	844 - 1169	936 - 1317	2650 - 4036

①	②	③				④	
Inches	Width × Height	ELPLM0 7 ELPLM1 1	ELPLM0 9 ELPLM1 5 ELPLS04	ELPLL07 ELPLL08	ELPLR04	Except for ELPLU03 S/ELPL W05/ELP LR04	ELPLU03 S ELPLW0 5
250	538 × 337	1928 - 2934	855 - 1385	2867 - 4020	382	-370 - 34	-249 - -87
300	646 × 404	2319 - 3526	1027 - 1663	3447 - 4830	460	-444 - 41	-299 - -105
500	1077 × 673	3881 - 5892	1717 - 2777	5765 - 8071	771	-741 - 68	-499 - -175

16:9

①	②	③				④	
Inches	Width × Height	ELPLM0 7 ELPLM1 1	ELPLM0 9 ELPLM1 5 ELPLS04	ELPLL07 ELPLL08	ELPLR04	Except for ELPLU03 S/ELPL W05/ELP LR04	ELPLU03 S ELPLW0 5
60	129 × 81	445 - 686	199 - 326	664 - 941	87	-89 - 8	-60 - -21
80	172 × 108	601 - 923	268 - 438	896 - 1265	118	-119 - 11	-80 - -28
100	215 × 135	757 - 1160	337 - 549	1128 - 1589	149	-148 - 14	-100 - -35
120	258 × 162	913 - 1396	406 - 661	1360 - 1913	180	-178 - 16	-120 - -42
150	323 × 202	1147 - 1751	509 - 828	1708 - 2399	227	-222 - 20	-150 - -52
200	431 × 269	1538 - 2343	682 - 1106	2287 - 3209	304	-296 - 27	-199 - -70

①	②	③	④
Inches	Width × Height	ELPLX02 ELPLX02S ELPLX02W ELPLX02WS	
98	217 × 122	74	0 - 34
100	221 × 125	76	0 - 35
120	266 × 149	92	0 - 42
150	332 × 187	116	0 - 52
200	443 × 249	155	0 - 69
300	664 × 374	235	0 - 104
400	886 × 498	314	0 - 138
500	1107 × 623	394	0 - 173
600	1328 × 747	473	0 - 208
800	1771 × 996	632	0 - 277
970	2147 × 1208	767	0 - 336

①	②	③					
Inches	Width × Height	ELPLU02 ELPLU04	ELPLU03 S	ELPLW0 4 ELPLW0 6	ELPLW0 5	ELPLW0 8	ELPLM0 6 ELPLM1 0
60	133 × 75	82 - 100	-	154 - 212	97 - 139	112 - 158	315 - 486
80	177 × 100	111 - 135	83 - 100	207 - 285	132 - 187	151 - 212	425 - 653
100	221 × 125	140 - 170	104 - 126	261 - 358	167 - 236	189 - 267	534 - 819
120	266 × 149	170 - 205	126 - 152	315 - 431	202 - 284	228 - 321	644 - 986
150	332 × 187	213 - 258	158 - 191	395 - 540	255 - 357	286 - 403	808 - 1236
200	443 × 249	286 - 346	212 - 256	530 - 723	343 - 477	383 - 538	1082 - 1652
250	553 × 311	359 - 433	266 - 320	664 - 905	430 - 598	479 - 674	1355 - 2068
300	664 × 374	432 - 521	320 - 385	798 - 1088	518 - 719	576 - 810	1629 - 2484
480	1063 × 598	695 - 837	514 - 618	1282 - 1745	833 - 1154	924 - 1299	2614 - 3983

①	②	③				④	
Inches	Width × Height	ELPLM0 7 ELPLM1 1	ELPLM0 9 ELPLM1 5 ELPLS04	ELPLL07 ELPLL08	ELPLR04	Except for ELPLU03 S/ELPL W05/ELP LR04	ELPLU03 S ELPLW0 5
100	221 × 125	799 - 1192	347 - 565	1160 - 1634	153	-145 - 21	-96 - -29
120	266 × 149	939 - 1436	417 - 679	1398 - 1967	185	-174 - 25	-115 - -35
150	332 × 187	1180 - 1800	524 - 851	1756 - 2467	233	-218 - 31	-143 - -43
200	443 × 249	1581 - 2408	701 - 1137	2352 - 3300	313	-291 - 42	-191 - -58
250	553 × 311	1983 - 3016	879 - 1423	2948 - 4132	393	-363 - 52	-239 - -72
300	664 × 374	2384 - 3624	1056 - 1710	3543 - 4965	473	-436 - 63	-287 - -87
480	1063 × 598	3829 - 5813	1694 - 2740	5688 - 7963	761	-698 - 100	-459 - -139

4:3

①	②	③				④	
Inches	Width × Height	ELPLM0 7 ELPLM1 1	ELPLM0 9 ELPLM1 5 ELPLS04	ELPLL07 ELPLL08	ELPLR04	Except for ELPLU03 S/ELPL W05/ELP LR04	ELPLU03 S ELPLW0 5
60	133 × 75	458 - 706	205 - 336	683 - 968	89	-87 - 13	-57 - -17
80	177 × 100	618 - 949	276 - 450	922 - 1301	121	-116 - 17	-76 - -23

①	②	③	④
Inches	Width × Height	ELPLX02 ELPLX02S ELPLX02W ELPLX02WS	
89	181 × 136	74	-7 - 27
100	203 × 152	84	-8 - 30
120	244 × 183	102	-9 - 37
150	305 × 229	128	-11 - 46
200	406 × 305	172	-15 - 61

①	②	③	④
Inches	Width × Height	ELPLX02 ELPLX02S ELPLX02W ELPLX02WS	
250	508 × 381	215	-19 - 76
300	610 × 457	259	-23 - 91
400	813 × 610	346	-30 - 122
500	1016 × 762	434	-38 - 152
800	1626 × 1219	696	-61 - 244
880	1788 × 1341	766	-67 - 268

①	②	③					
Inches	Width × Height	ELPLU02 ELPLU04	ELPLU03 S	ELPLW0 4 ELPLW0 6	ELPLW0 5	ELPLW0 8	ELPLM0 6 ELPLM1 0
440	894 × 671	702 - 845	519 - 624	1295 - 1762	841 - 1165	933 - 1312	2640 - 4021

①	②	③					
Inches	Width × Height	ELPLU02 ELPLU04	ELPLU03 S	ELPLW0 4 ELPLW0 6	ELPLW0 5	ELPLW0 8	ELPLM0 6 ELPLM1 0
60	122 × 91	91 - 110	-	170 - 234	108 - 154	124 - 174	349 - 537
80	163 × 122	123 - 149	91 - 111	229 - 315	147 - 207	166 - 234	469 - 720
100	203 × 152	155 - 188	115 - 139	288 - 395	185 - 260	209 - 294	590 - 904
120	244 × 183	187 - 226	139 - 168	348 - 475	224 - 313	251 - 354	710 - 1087
150	305 × 229	236 - 284	175 - 211	436 - 596	282 - 393	315 - 444	891 - 1362
200	406 × 305	316 - 381	234 - 282	584 - 797	378 - 526	422 - 594	1193 - 1821
250	508 × 381	396 - 478	293 - 353	732 - 998	475 - 659	528 - 743	1494 - 2279
300	610 × 457	477 - 574	353 - 424	880 - 1199	571 - 792	635 - 893	1796 - 2738

①	②	③				④	
Inches	Width × Height	ELPLM0 7 ELPLM1 1	ELPLM0 9 ELPLM1 5 ELPLS04	ELPLL07 ELPLL08	ELPLR04	Except for ELPLU03 S/ELPL W05/ELP LR04	ELPLU03 S ELPLW0 5
60	122 × 91	507 - 780	226 - 370	756 - 1069	99	-101 - 9	-68 - -24
80	163 × 122	683 - 1048	304 - 497	1019 - 1436	134	-134 - 12	-90 - -32
100	203 × 152	860 - 1316	383 - 623	1281 - 1803	169	-168 - 15	-113 - -40
120	244 × 183	1037 - 1584	461 - 749	1544 - 2170	205	-201 - 18	-135 - -47
150	305 × 229	1302 - 1985	578 - 938	1937 - 2720	257	-252 - 23	-169 - -59
200	406 × 305	1744 - 2655	773 - 1253	2594 - 3637	345	-335 - 31	-226 - -79
250	508 × 381	2186 - 3325	969 - 1569	3250 - 4555	433	-419 - 38	-282 - -99
300	610 × 457	2628 - 3995	1164 - 1884	3906 - 5472	521	-503 - 46	-339 - -119
440	894 × 671	3866 - 5870	1711 - 2767	5744 - 8041	768	-738 - 67	-497 - -174

EB-PU1008B/EB-PU1008W/EB-PU1007B/EB-PU1007W/EB-PU1006W:

16:10

①	②	③	
Inches	Width × Height	ELPLX01 ELPLX01S ELPLX01W ELPLX01WS	
100	215 × 135	74	0 - 24
120	258 × 162	89	0 - 29
150	323 × 202	113	0 - 36
200	431 × 269	152	0 - 48
250	538 × 337	192	0 - 59
300	646 × 404	231	0 - 71
400	862 × 538	310	0 - 95
500	1077 × 673	388	0 - 119
800	1723 × 1077	625	0 - 190
1000	2154 × 1346	782	0 - 238

①	②	③					
Inches	Width × Height	ELPLU02 ELPLU04	ELPLU03 S	ELPLW0 4 ELPLW0 6	ELPLW0 5	ELPLW0 8	ELPLM0 6 ELPLM1 0
120	258 × 162	227 - 274	169 - 203	422 - 576	271 - 379	305 - 429	863 - 1311
150	323 × 202	285 - 344	212 - 255	529 - 722	341 - 475	383 - 537	1082 - 1641
200	431 × 269	382 - 460	283 - 341	708 - 965	457 - 636	512 - 718	1447 - 2193
250	538 × 337	479 - 577	355 - 427	887 - 1208	573 - 796	641 - 899	1812 - 2744
300	646 × 404	576 - 693	427 - 513	1066 - 1452	690 - 956	770 - 1080	2177 - 3296
500	1077 × 673	964 - 1159	714 - 857	1781 - 2425	1154 - 1597	1287 - 1803	3637 - 5502
800	1723 × 1077	1546 - 1858	1145 - 1373	2854 - 3885	1852 - 2559	2061 - 2888	5827 - 8811
1000	2154 × 1346	1934 - 2324	1432 - 1717	3569 - 4859	2317 - 3201	2578 - 3611	7287 - 11017

①	②	③					
Inches	Width × Height	ELPLU02 ELPLU04	ELPLU03 S	ELPLW0 4 ELPLW0 6	ELPLW0 5	ELPLW0 8	ELPLM0 6 ELPLM1 0
50	108 × 67	91 - 111	-	172 - 235	109 - 155	124 - 175	352 - 538
60	129 × 81	111 - 134	-	207 - 284	132 - 187	150 - 212	425 - 649
80	172 × 108	149 - 181	111 - 134	279 - 381	178 - 251	202 - 284	571 - 869
100	215 × 135	188 - 227	140 - 168	350 - 478	225 - 315	253 - 356	717 - 1090

①	②	③					④
Inches	Width × Height	ELPLM0 7 ELPLM1 1	ELPLM0 8	ELPLM0 9 ELPLM1 5 ELPLS04	ELPLL07 ELPLL08	ELPLR04	Except for ELPLR04
50	108 × 67	511 - 784	153 - 248	229 - 372	761 - 1074	100	-79 - 12
60	129 × 81	618 - 945	185 - 298	276 - 447	920 - 1295	121	-95 - 14
80	172 × 108	832 - 1268	248 - 399	370 - 599	1237 - 1737	163	-127 - 19

①	②	③					④
Inches	Width × Height	ELPLM07 ELPLM11	ELPLM08	ELPLM09 ELPLM15 ELPLS04	ELPLL07 ELPLL08	ELPLR04	Except for ELPLR04
100	215 × 135	1046 - 1591	311 - 500	465 - 751	1555 - 2180	206	-158 - 24
120	258 × 162	1260 - 1913	374 - 601	560 - 903	1872 - 2622	248	-190 - 29
150	323 × 202	1581 - 2398	469 - 753	702 - 1131	2348 - 3285	312	-238 - 36
200	431 × 269	2116 - 3205	627 - 1005	938 - 1510	3141 - 4391	417	-317 - 48
250	538 × 337	2651 - 4012	785 - 1258	1175 - 1890	3935 - 5497	523	-396 - 59
300	646 × 404	3186 - 4819	943 - 1510	1411 - 2269	4728 - 6602	629	-475 - 71
500	1077 × 673	5326 - 8047	1576 - 2520	2357 - 3787	7901 - 11025	1053	-792 - 119
800	1723 × 1077	8536 - 12889	2524 - 4035	3776 - 6064	12661 - 17659	1688	-1267 - 190
1000	2154 × 1346	10676 - 16117	3157 - 5044	4722 - 7582	15834 - 22082	2112	-1584 - 238

16:9

①	②	③	④
Inches	Width × Height	ELPLX01 ELPLX01S ELPLX01W ELPLX01WS	
100	221 × 125	76	7 - 31
120	266 × 149	92	8 - 38

①	②	③	④
Inches	Width × Height	ELPLX01 ELPLX01S ELPLX01W ELPLX01WS	
150	332 × 187	116	10 - 47
200	443 × 249	157	14 - 63
250	553 × 311	197	17 - 78
300	664 × 374	238	21 - 94
400	886 × 498	318	28 - 125
500	1107 × 623	399	35 - 157
800	1771 × 996	642	55 - 251
1000	-	-	-

①	②	③					
Inches	Width × Height	ELPLU02 ELPLU04	ELPLU03 S	ELPLW04 ELPLW06	ELPLW05	ELPLW08	ELPLM06 ELPLM10
49	109 × 61	92 - 112	-	173 - 237	109 - 156	125 - 177	355 - 542
50	111 × 62	94 - 114	-	176 - 242	112 - 159	128 - 180	362 - 554
60	133 × 75	114 - 138	-	213 - 292	136 - 192	154 - 218	437 - 667
80	177 × 100	154 - 186	114 - 138	287 - 392	183 - 258	208 - 292	587 - 894
100	221 × 125	194 - 234	144 - 173	360 - 492	231 - 324	261 - 366	737 - 1121
120	266 × 149	234 - 282	173 - 209	434 - 592	279 - 390	314 - 441	887 - 1347
150	332 × 187	293 - 354	218 - 262	544 - 742	351 - 489	393 - 552	1112 - 1687

①	②	③					
Inches	Width × Height	ELPLU02 ELPLU04	ELPLU03 S	ELPLW0 4 ELPLW0 6	ELPLW0 5	ELPLW0 8	ELPLM0 6 ELPLM1 0
200	443 × 249	393 - 473	291 - 350	728 - 992	470 - 653	526 - 738	1488 - 2254
250	553 × 311	493 - 593	365 - 439	912 - 1242	590 - 818	659 - 924	1863 - 2821
300	664 × 374	592 - 713	439 - 527	1096 - 1492	709 - 983	792 - 1110	2238 - 3388
500	1107 × 623	991 - 1192	734 - 881	1831 - 2493	1187 - 1642	1323 - 1853	3738 - 5655
800	1771 × 996	1589 - 1910	1177 - 1412	2934 - 3994	1903 - 2631	2119 - 2969	5989 - 9056
1000	2214 × 1245	-	-	-	-	-	-

①	②	③					④
Inches	Width × Height	ELPLM0 7 ELPLM1 1	ELPLM0 8	ELPLM0 9 ELPLM1 5 ELPLS04	ELPLL07 ELPLL08	ELPLR04	Except for ELPLR04
49	109 × 61	515 - 789	154 - 250	230 - 374	767 - 1082	101	-76 - 15
50	111 × 62	526 - 806	157 - 255	235 - 382	784 - 1105	103	-78 - 16
60	133 × 75	636 - 972	190 - 307	284 - 460	947 - 1332	124	-94 - 19
80	177 × 100	856 - 1304	255 - 411	381 - 616	1273 - 1787	168	-125 - 25
100	221 × 125	1076 - 1635	320 - 514	478 - 772	1599 - 2241	212	-156 - 31

①	②	③					④
Inches	Width × Height	ELPLM0 7 ELPLM1 1	ELPLM0 8	ELPLM0 9 ELPLM1 5 ELPLS04	ELPLL07 ELPLL08	ELPLR04	Except for ELPLR04
120	266 × 149	1296 - 1967	385 - 618	575 - 928	1925 - 2696	255	-187 - 38
150	332 × 187	1626 - 2465	482 - 774	721 - 1162	2414 - 3378	320	-234 - 47
200	443 × 249	2176 - 3294	645 - 1033	964 - 1552	3230 - 4514	429	-312 - 63
250	553 × 311	2726 - 4124	807 - 1293	1207 - 1942	4045 - 5650	538	-390 - 78
300	664 × 374	3276 - 4953	970 - 1552	1450 - 2332	4860 - 6787	647	-468 - 94
500	1107 × 623	5475 - 8271	1620 - 2590	2423 - 3893	8122 - 11333	1082	-779 - 157
800	1771 × 996	8774 - 13248	2595 - 4147	3881 - 6233	13014 - 18151	1735	-1247 - 251
1000	2214 × 1245	-	-	-	-	-	-1559 - 313

4:3

①	②	③	④
Inches	Width × Height	ELPLX01 ELPLX01S ELPLX01W ELPLX01WS	
90	183 × 137	75	0 - 24
100	203 × 152	84	0 - 27
120	244 × 183	102	0 - 32

①	②	③	
Inches	Width × Height	ELPLX01 ELPLX01S ELPLX01W ELPLX01WS	
150	305 × 229	129	0 - 40
200	406 × 305	173	0 - 54
250	508 × 381	218	0 - 67
300	610 × 457	262	0 - 81
400	813 × 610	351	0 - 108
500	1016 × 762	440	0 - 134
800	1626 × 1219	708	0 - 215
1000	-	-	-

①	②	③					
Inches	Width × Height	ELPLU02 ELPLU04	ELPLU03 S	ELPLW0 4 ELPLW0 6	ELPLW0 5	ELPLW0 8	ELPLM0 6 ELPLM1 0
200	406 × 305	434 - 522	321 - 386	803 - 1094	519 - 720	580 - 813	1640 - 2484
250	508 × 381	543 - 654	403 - 483	1005 - 1369	650 - 902	726 - 1018	2053 - 3109
300	610 × 457	653 - 786	484 - 581	1207 - 1645	782 - 1083	872 - 1223	2466 - 3733
500	1016 × 762	1092 - 1313	809 - 971	2017 - 2747	1308 - 1809	1457 - 2042	4119 - 6230
800	1626 × 1219	1751 - 2105	1297 - 1555	3232 - 4400	2097 - 2898	2334 - 3270	6598 - 9976
1000	2032 × 1524	-	-	-	-	-	-

①	②	③					
Inches	Width × Height	ELPLU02 ELPLU04	ELPLU03 S	ELPLW0 4 ELPLW0 6	ELPLW0 5	ELPLW0 8	ELPLM0 6 ELPLM1 0
45	91 × 69	93 - 113	-	175 - 240	111 - 158	127 - 179	359 - 549
50	102 × 76	104 - 126	-	195 - 267	124 - 176	141 - 199	400 - 611
60	122 × 91	126 - 153	-	236 - 322	150 - 212	171 - 240	483 - 736
80	163 × 122	170 - 205	126 - 152	317 - 432	203 - 285	229 - 322	648 - 986
100	203 × 152	214 - 258	159 - 191	398 - 543	255 - 357	288 - 404	813 - 1236
120	244 × 183	258 - 311	191 - 230	479 - 653	308 - 430	346 - 486	979 - 1485
150	305 × 229	324 - 390	240 - 289	600 - 818	387 - 539	434 - 609	1227 - 1860

①	②	③					④
Inches	Width × Height	ELPLM0 7 ELPLM1 1	ELPLM0 8	ELPLM0 9 ELPLM1 5 ELPLS04	ELPLL07 ELPLL08	ELPLR04	Except for ELPLR04
45	91 × 69	521 - 799	156 - 253	233 - 379	776 - 1095	102	-81 - 12
50	102 × 76	582 - 890	174 - 281	260 - 422	866 - 1220	114	-90 - 13
60	122 × 91	703 - 1073	210 - 338	313 - 508	1046 - 1470	138	-108 - 16
80	163 × 122	945 - 1438	281 - 453	420 - 679	1405 - 1971	186	-143 - 22
100	203 × 152	1188 - 1804	353 - 567	527 - 851	1764 - 2472	234	-179 - 27

①	②	③					④
Inches	Width × Height	ELPLM07 ELPLM11	ELPLM08	ELPLM09 ELPLM15 ELPLS04	ELPLL07 ELPLL08	ELPLR04	Except for ELPLR04
120	244 × 183	1430 - 2169	424 - 681	635 - 1023	2124 - 2972	282	-215 - 32
150	305 × 229	1793 - 2717	532 - 853	795 - 1281	2662 - 3724	354	-269 - 40
200	406 × 305	2399 - 3631	711 - 1139	1063 - 1711	3561 - 4975	473	-359 - 54
250	508 × 381	3005 - 4544	890 - 1424	1331 - 2140	4459 - 6227	593	-448 - 67
300	610 × 457	3610 - 5458	1069 - 1710	1598 - 2570	5357 - 7479	713	-538 - 81
500	1016 × 762	6033 - 9112	1785 - 2853	2669 - 4288	8949 - 12485	1193	-896 - 134
800	1626 × 1219	9667 - 14594	2858 - 4568	4276 - 6866	14338 - 19996	1912	-1434 - 215
1000	2032 × 1524	-	3574 - 5711	-	-	-	-1793 - 269

Product name	EB-PU2010B/EB-PU2010W/EB-PU1008B/EB-PU1008W/EB-PU1007B/EB-PU1007W/EB-PU1006W
Dimensions	545 (W) × 164 (H) × 436 (D) mm (not including raised section)
Projection system	RGB liquid crystal shutter
LCD panel size	EB-PU2010B/EB-PU2010W: 1.0" EB-PU1008B/EB-PU1008W/EB-PU1007B/EB-PU1007W/EB-PU1006W: 0.76"
Display method	Poly-silicon TFT active matrix
Resolution	2,304,000 pixels WUXGA (1920 (W) × 1200 (H) dots) × 3
Focus adjustment	Powered
Zoom adjustment	1.0 to 1.6 (Optical Zoom)
Projection lens	Optional lens supported. EB-PU2010B/EB-PU2010W: Standard lens: ELPLM15 EB-PU1008B/EB-PU1008W/EB-PU1007B/EB-PU1007W/EB-PU1006W: Standard lens: ELPLM08
Lens Shift	Powered EB-PU2010B/EB-PU2010W: Maximum vertical direction: Approx. ±60% Maximum horizontal direction: Approx. ±18% EB-PU1008B/EB-PU1008W/EB-PU1007B/EB-PU1007W/EB-PU1006W: Maximum vertical direction: Approx. ±67% Maximum horizontal direction: Approx. ±30%
Light source	Laser diode

Light source output power	EB-PU2010B/EB-PU2010W/EB-PU1008B/EB-PU1008W: Up to 176 W EB-PU1007B/EB-PU1007W: Up to 132 W EB-PU1006W: Up to 115.5 W
Wavelength	449 to 461 nm
Light source operation time *	Normal or Quiet Light Source Mode: Up to about 20,000 hours Extended Light Source Mode: Up to about 30,000 hours
Brightness**	EB-PU2010B/EB-PU2010W: Normal Light Source Mode: 10,000 lm Medium Light Source Mode: 8,500 lm Quiet or Extended Light Source Mode: 7,000 lm EB-PU1008B/EB-PU1008W: Normal Light Source Mode: 8,500 lm Medium Light Source Mode: 7,225 lm Quiet or Extended Light Source Mode: 5,950 lm EB-PU1007B/EB-PU1007W: Normal Light Source Mode: 7,000 lm Medium Light Source Mode: 5,950 lm Quiet or Extended Light Source Mode: 4,900 lm EB-PU1006W: Normal Light Source Mode: 6,000 lm Medium Light Source Mode: 5,100 lm Quiet or Extended Light Source Mode: 4,200 lm
Contrast ratio	2,500,000:1 exceeded (Dynamic Contrast Normal/High Speed)
Color reproducibility	Up to 1,070 million colors (Depends on the interface)

Scanning frequency	Analog: Horizontal: 31.25 to 92 kHz Vertical: 50 to 85 Hz HDMI/HDBaseT/DVI-D: Horizontal: 15 to 135 kHz Vertical: 23.98/24/25/29.97/30/50/59.94/60 Hz SDI (EB-PU2010B/EB-PU2010W only): Horizontal: 15 to 67.5 kHz Vertical: 23.98/24/25/29.97/30/50/59.94/60 Hz
Power supply	EB-PU2010B/EB-PU2010W/EB-PU1008B/EB-PU1008W/EB-PU1007B/EB-PU1007W: 100-240V AC±10% 50/60Hz 5.6 - 2.5 A EB-PU1006W: 100-240V AC±10% 50/60Hz 3.9 - 1.7 A
Operating power consumption (100 to 120 V area)	EB-PU2010B/EB-PU2010W/EB-PU1008B/EB-PU1008W: Light Source Mode: Normal, Custom: 559 W Light Source Mode: Quiet, Extended: 469 W EB-PU1007B/EB-PU1007W: Light Source Mode: Normal, Custom: 448 W Light Source Mode: Quiet, Extended: 379 W EB-PU1006W: Light Source Mode: Normal, Custom: 384 W Light Source Mode: Quiet, Extended: 321 W
Operating power consumption (220 to 240 V area)	EB-PU2010B/EB-PU2010W/EB-PU1008B/EB-PU1008W: Light Source Mode: Normal, Custom: 535 W Light Source Mode: Quiet, Extended: 452 W EB-PU1007B/EB-PU1007W: Light Source Mode: Normal, Custom: 431 W Light Source Mode: Quiet, Extended: 366 W EB-PU1006W: Light Source Mode: Normal, Custom: 367 W Light Source Mode: Quiet, Extended: 310 W

Standby power consumption	Communication On: 2.0 W Communication Off: 0.5 W
Thermal output (max.)	EB-PU2010B/EB-PU2010W/EB-PU1008B/EB-PU1008W: 100 to 120 V area: 1900.6 BTU/h 220 to 240 V area: 1819.0 BTU/h EB-PU1007B/EB-PU1007W: 100 to 120 V area: 1523.2 BTU/h 220 to 240 V area: 1465.4 BTU/h EB-PU1006W: 100 to 120 V area: 1305.6 BTU/h 220 to 240 V area: 1247.8 BTU/h
Air flow (max.)	176.1 CFM
Operating altitude	Altitude 0 to 3,048 m
Operating temperature (when using a single projector installation) ***	EB-PU2010B/EB-PU2010W: Altitude of 0 to 2,286 m: 0 to +50°C (Humidity of 20 to 80%, No condensation) Altitude of 2,287 to 3,048 m: 0 to +45°C (Humidity of 20 to 80%, No condensation) EB-PU1008B/EB-PU1008W/EB-PU1007B/EB-PU1007W/EB-PU1006W: Altitude of 0 to 2,286 m: 0 to +45°C (Humidity of 20 to 80%, No condensation) Altitude of 2,287 to 3,048 m: 0 to +40°C (Humidity of 20 to 80%, No condensation)
Storage temperature	-10 to +60°C (No condensation)
Mass	EB-PU2010B/EB-PU2010W: Approx. 16.8 kg EB-PU1008B/EB-PU1008W/EB-PU1007B/EB-PU1007W: Approx. 16.3 kg EB-PU1006W: Approx. 15.4 kg

Network	RJ45 (100BASE-TX/10BASE-T) x 1, USB connector (A type) x 1 (wireless LAN unit Corresponding to IEEE802.11a(5GHz)/b(2.4GHz)/g(2.4GHz)/n(2.4GHz, 5GHz))
---------	---

* Approximate time until the light source brightness decreases to half of its original value. (Assuming the projector is being used in an environment containing airborne particles of 0.04 mg/m³ or less. This is an approximate guide only and may change depending on the projector's usage and surroundings.)

**The specifications are when the standard lens is attached.









*** Light source brightness automatically dims if the surrounding temperature gets too high. (Approximately 35°C at an altitude of 0 to 2,286 m, and approximately 30°C at an altitude of 2,287 to 3,048 m; however, this may vary depending on the surrounding environment.)









This product is also designed for IT power distribution system with phase-to-phase voltage 230V.









Your projector supports the following features and options of the Epson Projector Content Manager software.

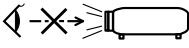

Features/Options		
Simultaneous playback		-
Save the playlist to the projector via a network		✓
Settings > Video Format	Auto Select	✓
	AVI Format	✓
	MP4 Format	✓

The following table lists the meaning of the safety symbols labeled on the equipment.

No.	Symbol mark	Approved standards	Description
1		IEC60417 No. 5007	"ON" (power) To indicate connection to the mains.
2		IEC60417 No. 5008	"OFF" (power) To indicate disconnection from the mains.
3		IEC60417 No. 5009	Stand-by To identify the switch or switch position by means of which part of the equipment is switched on in order to bring it into the stand-by condition.
4		ISO7000 No. 0434B, IEC3864-B3.1	Caution To identify general caution when using the product.
5		IEC60417 No. 5041	Caution, hot surface To indicate that the marked item can be hot and should not be touched without taking care.
6		IEC60417 No. 6042 ISO3864-B3.6	Caution, risk of electric shock To identify equipment that has risk of electric shock.
7		IEC60417 No. 5957	For indoor use only To identify electrical equipment designed primarily for indoor use.
8		IEC60417 No. 5926	Polarity of d.c. power connector To identify the positive and negative connections (the polarity) on a piece of equipment to which a d.c. power supply may be connected.

No.	Symbol mark	Approved standards	Description
9		—	The same as No. 8.
10		IEC60417 No. 5001B	Battery, general On battery powered equipment. To identify a device for instance a cover for the battery compartment, or the connector terminals.
11		IEC60417 No. 5002	Positioning of cell To identify the battery holder itself and to identify the positioning of the cell(s) inside the battery holder.
12		—	The same as No. 11.
13		IEC60417 No. 5019	Protective earth To identify any terminal which is intended for connection to an external conductor for protection against electric shock in case of a fault, or the terminal of a protective earth electrode.
14		IEC60417 No. 5017	Earth To identify an earth (ground) terminal in cases where neither the symbol No. 13 is explicitly required.
15		IEC60417 No. 5032	Alternating current To indicate on the rating plate that the equipment is suitable for alternating current only; to identify relevant terminals.
16		IEC60417 No. 5031	Direct current To indicate on the rating plate that the equipment is suitable for direct current only; to identify relevant terminals.

No.	Symbol mark	Approved standards	Description
17		IEC60417 No. 5172	Class II equipment To identify equipment meeting the safety requirements specified for Class II equipment according to IEC 61140.
18		ISO 3864	General prohibition To identify actions or operations that are prohibited.
19		ISO 3864	Contact prohibition To indicate injury that could occur due to touching a specific part of the equipment.
20		—	Never look into the optical lens while the projector is on.
21		—	To indicate that the marked item don't place anything on projector.
22		ISO3864 IEC60825-1	Caution, laser radiation To indicate the equipment has a laser radiation part.
23		ISO 3864	Disassembly prohibition To indicate a risk of injury, such as electric shock, if the equipment is disassembled.
24		IEC60417 No. 5266	Standby, partial standby To indicate that part of the equipment is in the ready status.
25		ISO3864 IEC60417 No. 5057	Caution, movable parts To indicate that you must keep away from movable parts according to protection standards.
26		IEC60417 No. 6056	Caution (Moving Fan Blades) As a safety precaution, stay away from the moving fan blades.

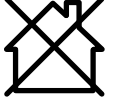
No.	Symbol mark	Approved standards	Description
27		IEC60417 No. 6043	Caution (Sharp Corners) To indicate sharp corners that should not be touched.
28		—	To indicate that looking into the lens while projecting is prohibited.
29		ISO7010 No. W027 ISO 3864	Warning, Optical radiation (such as UV, visible radiation, IR) Taking care to avoid injury to eyes and skin when in the vicinity of optical radiation.
30		IEC60417 No. 5109	Not to be used in residential areas. To identify electrical equipment which is not suitable for a residential area.

This projector is a Class 1 laser product that complies with the IEC/EN60825-1:2014 international standard for lasers.

Follow these safety instructions when using the projector.

Warning

- Do not open the projector's case. The projector contains a high-powered laser.
- Possibly hazardous optical radiation emitted from this product. Do not look at operating light source. Eye injury may result.
- As with any bright source, do not stare into the beam, RG2 IEC/EN 62471-5:2015.
- This projector may become RG3 when an interchangeable lens with a throw ratio greater than 3.5 is installed. See the manual for the lens list and hazardous distances before operation. Such combinations of projector and lens are intended for professional use only, and are not intended for consumer use.

Caution

Do not disassemble the projector when disposing of it. Dispose according to your local or national laws and regulations.



The projector uses a laser as the light source. The laser has the following characteristics.

- Depending on the surroundings, the brightness of the light source may decline. The brightness declines a lot when the temperature gets too high.
- The brightness of the light source declines the longer it is used. You can change the relationship between usage time and decline in brightness settings.

Related Links

- "Laser Warning Labels" p.186

Laser Warning Labels

Laser warning labels are attached on the projector.

Inside



Top

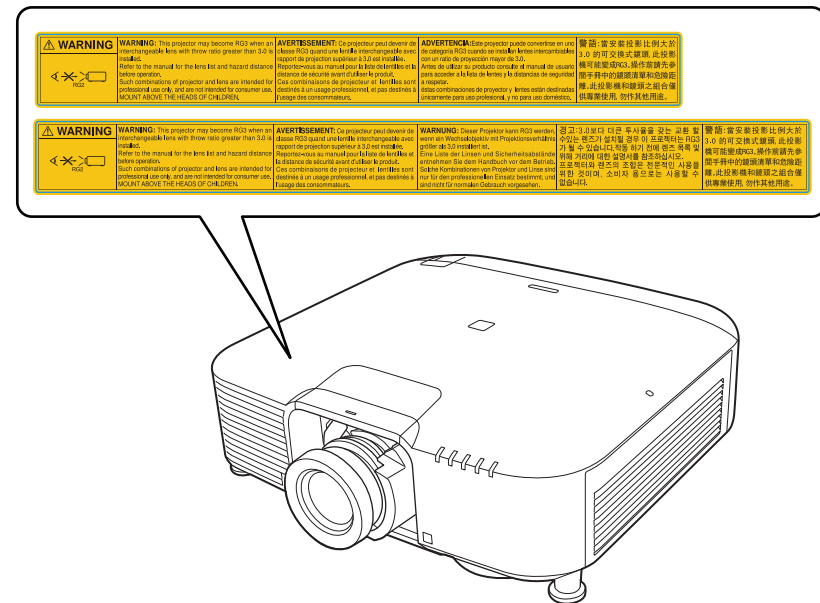

- Never look into the projector lens when the laser is on. This can damage your eyes and is especially dangerous for children and pets.

- When turning on the projector at a distance using the remote control, make sure no one is looking into the lens.
- Do not allow small children to operate the projector. Children must be accompanied by an adult.
- Do not look into the lens during projection. Also, do not look into the lens using optical devices, such as a magnifying glass or telescope. This could cause visual impairment.

For North/South America

Warning

MOUNT ABOVE THE HEADS OF CHILDREN. The use of a ceiling mount is recommended with this product to place it above the eyes of children.

Complies with FDA performance standards for laser products except for conformance as a Risk Group 2 LIP as defined in IEC 62471-5: Ed. 1.0. For more information see Laser Notice No. 57, dated May 8, 2019.

When using projectors and interchangeable lenses that change to Risk Group 3, no direct exposure to the beam is permitted. Operators must control access to the beam within the hazard distance or install the product at a height that will prevent eye exposure within the hazard distance.

Looking into the lens at distances closer than those indicated here can cause damage to eyesight.

Hazard Distance

Model number	EB-PU2010B/EB-PU2010W		EB-PU1008B/EB-PU1008W/EB-PU1007B/EB-PU1007W/EB-PU1006W	
	Wide	Tele	Wide	Tele
ELPLX01	-	-	0.077707	-
ELPLX02	0.064472	-	-	-
ELPLU04	0.144062	0.159626	0.225085	0.255771
ELPLU06	0.107832	0.112244	0.158973	0.168981
ELPLW05	0.174819	0.199180	0.247217	0.287469
ELPLW06	0.290640	0.348411	0.469469	0.559934
ELPLW08	0.193414	0.235421	0.286779	0.348966
ELPLM08	0.279407	0.368156	0.446497	0.587820
ELPLM10	0.747436	1.031958	1.218226	1.652385
ELPLM11	1.139332	1.557715	1.840188	2.484002
ELPLM15	0.427624	0.653690	0.696229	1.045020
ELPLL08	1.673773	1.995392	2.630942	3.116840

EB-PU2010B/EB-PU2010W:

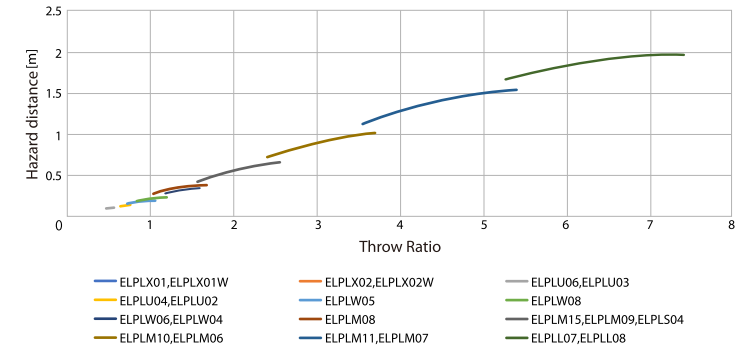

EB-PU1008B/EB-PU1008W/EB-PU1007B/EB-PU1007W/EB-PU1006W:

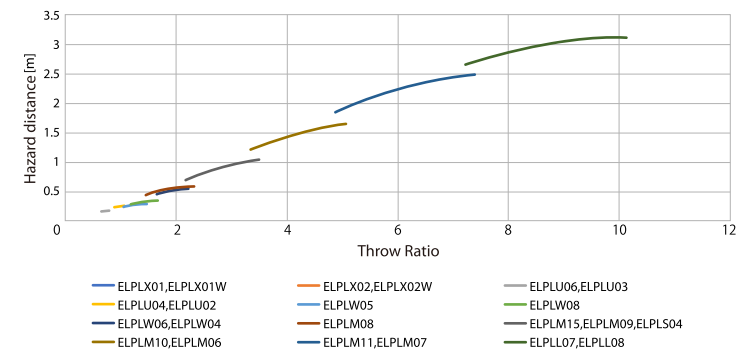

Check these sections for important notices about your projector.

► **Related Links**

- "FCC Compliance Statement" [p.189](#)
- "Indication of the manufacturer and the importer in accordance with requirements of EU directive" [p.190](#)
- "Indication of the manufacturer and the importer in accordance with requirements of United Kingdom directive" [p.190](#)
- "Restriction of Use" [p.190](#)
- "Operating System References" [p.190](#)
- "Trademarks" [p.190](#)
- "Copyright Notice" [p.191](#)
- "Copyright Attribution" [p.191](#)

FCC Compliance Statement

Supplier's DECLARATION of CONFORMITY

According to 47CFR, Part 2 and 15

Class B Personal Computers and Peripherals; and/or

CPU Boards and Power Supplies used with Class B Personal Computers

We: Epson America, Inc.

Located at: 3131 Katella Avenue, Los Alamitos, CA

Tel: 562-981-3840

Declare under sole responsibility that the product identified herein, complies with 47CFR Part 2 and 15 of the FCC rules as a Class B digital device. Each product marketed, is identical to the representative unit tested and found to be compliant with the standards. Records maintained continue to reflect the equipment being produced can be expected to be within the variation accepted, due to quantity production and testing on a statistical basis as required by 47CFR 2.906. Operation is subject to the following two conditions: (1) this device may not cause harmful interference, and (2) this device must accept any interference received, including interference that may cause undesired operation.

Trade Name: EPSON

Type of Product: LCD Projector

Model: HA33B/HA34B/HA35B/HA52B

FCC Compliance Statement For United States Users

This device complies with part 15 of the FCC Rules. Operation is subject to the following two conditions: (1) This device may not cause harmful interference, and (2) this device must accept any interference received, including interference that may cause undesired operation.

This equipment has been tested and found to comply with the limits for a Class B digital device, pursuant to Part 15 of the FCC Rules. These limits are designed to provide reasonable protection against harmful interference in a residential installation. This equipment generates, uses, and can radiate radio frequency energy and, if not installed and used in accordance with the instructions, may cause harmful interference to radio communications. However, there is no guarantee that interference will not occur in a particular installation. If this equipment does cause interference to radio and television reception, which can be determined by turning the equipment off and on, the user is encouraged to try to correct the interference by one or more of the following measures.

- Reorient or relocate the receiving antenna.
- Increase the separation between the equipment and receiver.
- Connect the equipment into an outlet on a circuit different from that to which the receiver is connected.
- Consult the dealer or an experienced radio/TV technician for help.

WARNING

The connection of a non-shielded equipment interface cable to this equipment will invalidate the FCC Certification or Declaration of this device and may cause interference levels which exceed the limits established by the FCC for this equipment. It is the responsibility of the user to obtain and use a shielded equipment interface cable with this device. If this equipment has more than one interface connector, do not leave cables connected to unused interfaces. Changes or modifications not expressly approved by the manufacturer could void the user's authority to operate the equipment.

Indication of the manufacturer and the importer in accordance with requirements of EU directive

Manufacturer: SEIKO EPSON CORPORATION
Address: 3-5, Owa 3-chome, Suwa-shi, Nagano-ken 392-8502 Japan
Telephone: 81-266-52-3131
<http://www.epson.com/>

Importer: EPSON EUROPE B.V.
Address: Atlas Arena, Asia Building, Hoogoorddreef 5,1101 BA Amsterdam
Zuidoost
The Netherlands
Telephone: 31-20-314-5000
<http://www.epson.eu/>

Indication of the manufacturer and the importer in accordance with requirements of United Kingdom directive

Manufacturer: SEIKO EPSON CORPORATION
Address: 3-5, Owa 3-chome, Suwa-shi, Nagano-ken 392-8502 Japan
Telephone: 81-266-52-3131
<http://www.epson.com/>

Importer: Epson (UK) Ltd.
Address: Westside, London Road, Hemel Hempstead, Hertfordshire, HP3 9TD,
United Kingdom
<http://www.epson.co.uk>

Restriction of Use

When this product is used for applications requiring high reliability/safety such as transportation devices related to aviation, rail, marine, automotive etc.; disaster prevention devices; various safety devices etc; or functional/precision devices etc, you should use this product only after giving consideration to including fail-safes and redundancies into your design to maintain safety and total system reliability. Because this product was not intended for use in applications requiring extremely high reliability/safety such as aerospace equipment, main communication equipment, nuclear power control equipment, or medical equipment related to direct medical care etc, please make your own judgment on this product's suitability after a full evaluation.

Operating System References

- Microsoft® Windows® 8.1 operating system
- Microsoft® Windows® 10 operating system

In this guide, the operating systems above are referred to as "Windows 8.1" and "Windows 10". Furthermore, the collective term "Windows" is used to refer to them all.

- macOS 10.13.x
- macOS 10.14.x
- macOS 10.15.x
- macOS 11.0.x

In this guide, the collective term "Mac" is used to refer to all of the operating systems above.

Trademarks

EPSON is a registered trademark, EXCEED YOUR VISION and its logos are registered trademarks or trademarks of Seiko Epson Corporation.

Mac, OS X, and macOS are trademarks of Apple Inc.

Microsoft and Windows are trademarks or registered trademarks of Microsoft Corporation in the United States and/or other countries.

WPA2[®] and WPA3[®] are trademarks of Wi-Fi Alliance[®].

App Store is a service mark of Apple Inc.

Chrome, Chromebook, and Google Play are trademarks of Google LLC.

HDMI, the HDMI Logo and High-Definition Multimedia Interface are trademarks or registered trademarks of HDMI Licensing Administrator, Inc.



"QR Code" is a registered trademark of DENSO WAVE INCORPORATED.

PJLink trademark is a trademark applied for registration or is already registered in Japan, the United States of America and other countries and areas.

Crestron[®], Crestron Connected[®], Crestron Fusion[®], Crestron Control[®], and Crestron RoomView[®] are registered trademarks of Crestron Electronics, Inc.

Art-Net[™] Designed by and Copyright Artistic Licence Holdings Ltd.

Intel[®] is a registered trademark of Intel Corporation in the U.S. and/or other countries.

Extron[®] and XTP[®] are registered trademarks of RGB Systems. Incorporated.

HDBaseT[™] and the HDBaseT Alliance logo are trademarks of the HDBaseT Alliance.

The N-Mark is a trademark or registered trademark of NFC Forum, Inc. in the United States and in other countries.

Android TV[™] is a trademark of Google LLC.

Other product names used herein are also for identification purposes only and may be trademarks of their respective owners. Epson disclaims any and all rights in those marks.

permission of Seiko Epson Corporation. No patent liability is assumed with respect to the use of the information contained herein. Neither is any liability assumed for damages resulting from the use of the information contained herein.

Neither Seiko Epson Corporation nor its affiliates shall be liable to the purchaser of this product or third parties for damages, losses, costs, or expenses incurred by the purchaser or third parties as a result of: accident, misuse, or abuse of this product or unauthorized modifications, repairs, or alterations to this product, or (excluding the U.S.) failure to strictly comply with Seiko Epson Corporation's operating and maintenance instructions.

Seiko Epson Corporation shall not be liable against any damages or problems arising from the use of any options or any consumable products other than those designated as Original Epson Products or Epson Approved Products by Seiko Epson Corporation.

The contents of this guide may be changed or updated without further notice.

Copyright Attribution

This information is subject to change without notice.

© 2021 Seiko Epson Corporation

2021.4 414136100EN

Copyright Notice

All rights reserved. No part of this publication may be reproduced, stored in a retrieval system, or transmitted in any form or by any means, electronic, mechanical, photocopying, recording, or otherwise, without the prior written